

# iTero Element™ 5D and iTero Element™ 5D Plus imaging systems

User manual



it starts with iTero™



**Copyright**

© 2022 Align Technology, Inc. All rights reserved.

The information contained in this manual is subject to change without notice.

The hardware and software described in this manual are supplied under a Sales and Services Agreement and may be used only in accordance with the terms of that agreement.

No part of this manual may be reproduced, photocopied, stored in a retrieval system, or transmitted in any manner (electronic or mechanical) for any purpose other than the customer's normal usage, without the prior written permission of Align Technology.

English language version

PN 215411 Rev. B  
Updated November 2022

**Patents**

[www.aligntech.com/patents](http://www.aligntech.com/patents)

**Trademarks**

Align, Invisalign, ClinCheck and iTero among others, are trademarks and/or service marks of Align Technology, Inc. or one of its subsidiaries or affiliated companies and may be registered in the U.S. and/or other countries.

Any other trademarks or registered trademarks appearing in this manual are the property of their respective owners.

**Global headquarters****Align Technology, Inc.**

410 North Scottsdale Road,  
Suite 1300, Tempe,  
Arizona 85281,  
USA

[www.aligntech.com](http://www.aligntech.com)

Tel: +1 (408) 470-1000  
Fax: +1 (408) 470-1010

**Customer Support**

Tel: +1 (800) 577-8767  
E-mail: [iterosupport@aligntech.com](mailto:iterosupport@aligntech.com)



0344

**Align Technology Ltd.**

1 Yitzhak Rabin Rd.,  
Petach Tikva, 4925110,  
Israel

Tel: +972 (3) 634-1441  
Fax: +972 (3) 634-1440

**Align Technology B.V.**

Herikerbergweg 312  
1101 CT, Amsterdam  
The Netherlands

## Contraindications

For persons who have been diagnosed with Epilepsy, there is a risk of epileptic shock from the flashing light of the iTerO scanner. These persons should refrain from any eye contact with the flashing light associated with the system during operation.

## Compliance

### Class 1 laser compliance

This device complies with 21 CFR 1040.10 and IEC 60825-1.



### CSA compliance

This device complies with the following CSA standard for Canada and the USA: UL Std No. 60601-1 – Medical Electrical Equipment Part 1: General Requirements for Safety.



### FCC compliance

This device complies with Part 15 of FCC Rules and its operation is subject to the following two conditions:

1. This device may not cause harmful interference.
2. This device must accept any interference received, including interference that may cause undesired operation.



### FCC warning

Modifications to the device that are not expressly approved by the manufacturer may void your authority to operate the device under FCC Rules.

### Safety compliance

This device complies with the following safety standard:

IEC 60601-1 Medical electrical equipment - Part 1: General requirements for basic safety and essential performance.

### EMC compliance

This device complies with the following EMC standard:

IEC 60601-1-2 Medical electrical equipment - Part 1-2: General requirements for basic safety and essential performance - Collateral standard: Electromagnetic phenomena - Requirements and tests.

### ANATEL compliance

This device complies with ANATEL resolution nº 242/2000 under the number ANATEL 02563-15-06534.

## Nature of emitted scanner radiation

- **Electromagnetic radiation (EMR)** - When used as directed, the iTero scanner's level of electromagnetic radiation is similar to that of a personal computer and complies with International Standard IEC 60601-1-2.
- **Laser and LED radiation** - When used as directed, the iTero scanner's level of Laser and LED radiation is incapable of producing damage to eyes or other human tissue and complies with International standards IEC 62471 and IEC 60825-1.

## Symbols

The following symbols may appear on iTero Element 5D and iTero Element 5D Plus hardware components and may appear within this document and other iTero Element literature.



Follow instructions for use.



Type BF applied part.



Separate collection of electrical waste and electronic equipment is required. In compliance with the European Directive on Waste Electrical and Electronic Equipment (WEEE), do not dispose of this product in domestic or municipal waste. This device contains WEEE materials.

Please contact the EARN service.

Link for the online request form: <http://b2btool.earn-service.com/aligntech/select>



**Caution** - Wherever this symbol appears on the device, it is mandatory to refer to safety-related information in this document.



Do not re-use.

## "Rx only"

**CAUTION:** US Federal Law restricts this device to sale by or on the order of a licensed Dentist, Orthodontist, or Dental Professional. The system serves as a prescription medical device and should be operated by qualified health-care providers only.



Medical device manufacturer.



Catalogue number.



Serial number.



Alternating current.



Keep dry.



Temperature limit.



Batch code.



Atmospheric pressure limitation.



Humidity limitation.



Fragile, handle with care.



This side should be up.



IEC 60417-5031: Direct current.



Wand (scanning unit).



Unique device identifier.



Country of manufacture (including date of manufacture).



Medical device.



Consult the electronic instructions for use.



USB socket.



Electric battery.



IEC 60417-5009: STAND-BY.



Stepping prohibited.



Authorized representative in the European Community.



RoHS compliant for China.



CE mark.

## Safety instructions

Before beginning to work with the system, all users are required to read these safety instructions.

- Power supply** Power is supplied to the system via a medical-grade power supply. In iTero Element 5D Plus cart-configuration scanners, the power supply is enclosed in the base of the wheel stand. In iTero Element 5D Plus mobile-configuration scanners, the power supply is external.
- Battery power**
- Charging – the scanner battery will be fully charged after being plugged into a power source for 2 hours (iTero Element 5D) or 2.5 hours (iTero Element 5D Plus).
  - With a fully-charged battery, you can scan for up to 30 minutes using the wheel-stand or cart-configuration scanner, or 10 minutes using the mobile-configuration scanner.
- Warning:** The cart-configuration scanners are provided with two Li-ion rechargeable battery packs and the wheel-stand configuration and mobile-configuration scanners are provided with one battery pack. There is a danger of battery explosion if the screen is damaged. Do not use the scanner if dropped or any damage is noticed. Contact Customer Support.
- Use only the original AC/DC adaptor connected to the system to charge the batteries.
  - **Warning:** A failing Li-ion battery begins to hiss, bulge, and leak electrolytes. The electrolytes consist of lithium salt in an organic solvent (lithium hexafluorophosphate), which is highly flammable. Burning electrolytes can ignite combustible materials in close proximity.  
Please note, there is a risk of burns associated with this situation.
  - The screen should be stored and operated following the environmental conditions that appear in this manual. Do not expose the scanner to extreme heat sources, such as radiators and fireplaces.
  - Never operate the device without batteries! Do not use the batteries for any purpose other than the intended use of the product. Discard used batteries according to the manufacturer's instructions and local requirements.
  - Replace the batteries only with the same battery type supplied by Align.
- Electric warnings**
- Do not remove external panels, covers, and batteries in order to avoid electrical shock. There are no user-serviceable parts inside. In iTero Element 5D Plus scanners, you can open the cover of the diagnostics panel in case of system failure, only when required by Customer Support.
  - Do not connect the scanner to a mains supply without protective grounding, in order to avoid the risk of electrical shock.
- iTero Element 5D laptop configuration:**
- The iTero Element 5D laptop-configuration scanner is provided with a hub containing the power supply for the wand. Do not place the system on a wet surface or step on it, in order to avoid the risk of system damage and electrical shock.
  - Never connect the hub to a laptop that is not approved according to IEC 60950-1 or IEC 62368-1, as applicable. The laptop and all its accessories should be located at least 1.5m away from the patient. Do not scan a patient and touch the laptop or any of its accessories at the same time. Not following these instructions may lead to electrical shock.

<b>Electric precautions</b>	<ul style="list-style-type: none"><li>• Do not connect a non-Align-approved web camera to the USB sockets on the rear of the touch screen, in order to avoid the risk of electrical shock.</li><li>• Do not connect anything besides the iTerо wand to the USB sockets on the hub.</li><li>• Do not connect a power cable that is not supplied by Align Technology to the system, in order to avoid electrical shock.</li></ul>
<b>Wireless LAN</b>	<ul style="list-style-type: none"><li>• The system comes equipped with a wireless LAN unit.</li><li>• When using the product, maintain a separation distance of at least 20cm between the computing unit and all persons' bodies to ensure compliance with RF exposure requirements.</li></ul>
<b>Safety classifications</b>	<ul style="list-style-type: none"><li>• Type of protection against electrical shock: Class 1.</li><li>• Degree of protection against electrical shock: Type BF.</li><li>• Degree of protection against harmful ingress of water: Ordinary.</li><li>• Equipment not suitable for use in the presence of flammable anesthetic mixtures.</li><li>• Mode of operation: Continuous.</li></ul>
<b>Prescription health device</b>	The system serves as a prescription medical device and should be operated by qualified health-care providers only.
<b>Scanner precautions</b>	<ul style="list-style-type: none"><li>• The wand emits red laser light (680nm Class 1) as well as white LED emissions and 850nm LED emissions. Normal usage of the wand does not present any danger to the human eye. Avoid shining the wand directly into the patient's eyes.</li><li>• Avoid twisting, knotting, pulling, and stepping on the wand cable and the power cable.</li><li>• When the system is not in use, the wand should be placed in the cradle with the optical surface facing the cradle, in order to avoid eye contact with the laser beam, flickering white LED emission, and 850nm LED emission. Eye contact could cause damage to the eyes.</li><li>• Avoid activating the wand while the tip of the wand is outside the patient's mouth, in order to prevent eye damage.</li><li>• Avoid placing the wand in the cradle while the scanning operation is still active, in order to prevent eye damage.</li><li>• Do not use the equipment if a scanner malfunction occurs or if physical damage is observed, in order to avoid electrical shock or physical injury. Call Customer Support.</li></ul>
<b>Cleaning &amp; disinfection</b>	<p>To avoid cross-contamination, it is mandatory to:</p> <ul style="list-style-type: none"><li>• Clean and disinfect the wand, as described in <a href="#">Cleaning and disinfecting the wand</a>, and replace the wand sleeve, as described in <a href="#">Applying a wand sleeve</a>, before each patient session.</li><li>• Remove and replace gloves after each patient session.</li><li>• Discard torn, contaminated, or removed gloves.</li><li>• Replace the wand sleeve between each patient. Failing to replace the wand sleeve between patients may cause the inadvertent transfer of microorganisms and other contaminants from one patient to another.</li><li>• Dispose of wand sleeves according to standard operating procedures or local regulations for the disposal of contaminated medical waste.</li></ul>



**Unpacking & installing**

The system should be unpacked and installed following Align Technology's instructions, described in [Assembly instructions](#).

**Note:** Contact Customer Support if the scanner box is damaged or if the ShockDot indicator on the box has been activated.

**Work environment**

- The system should be moved between rooms with utmost care to avoid damage.
- Do not block the air vents on the wand and the computing unit.
- The system is intended for indoor use only. It should not be exposed to direct sunlight, excessive heat, or humidity.
- iTero Element 5D laptop configuration only: If the system has just been brought into the office from a hot, cold, or humid environment, it should be set aside until it has adjusted to room temperature, to avoid internal condensation.

**Electromagnetic interference precaution**

This device has been tested and found to comply with the requirements for medical devices according to standard IEC60601-1-2. This standard is designed to provide reasonable protection against harmful interference in a typical medical installation.

Avoid placing this device near frequency transmitting equipment or other sources of electrical and electromagnetic interference (e.g. cellular phones, mobile two-way radios, electrical appliances, RFID). High levels of such interference, due to close proximity or strength of the source, may result in disruption of performance of this device. In this case, the device can be returned to operation mode after user intervention or by auto-recovery.

**General****Notes:**

- Do not make any modifications to this equipment.
- Cart and wheel-stand configurations only: Do not remove the computing unit from the stand after assembly.

**Incident notification**

Any serious incidents in relation to the iTero device should be reported to Align Technology Ltd. and the competent authority of the Member State in which the user and patient are established.



## Contre-indications – French

Pour les personnes ayant un diagnostic d'épilepsie, la lumière clignotante du scanner iTero peut engendrer un risque de choc épileptique. Ces personnes doivent éviter tout contact visuel avec la lumière clignotante inhérente au système pendant le fonctionnement.

## Conformité – French

### Conformité du laser de classe 1

Cet appareil est conforme aux normes 21 CFR 1040.10 et IEC 60825-1.



### Conformité FCC

Cet équipement est conforme à la section 15 des règles la FCC. Son fonctionnement est soumis aux deux conditions suivantes :

1. Cet appareil ne doit causer aucune interférence nuisible.
2. Cet appareil doit accepter toute interférence reçue, y compris des interférences pouvant provoquer un fonctionnement non désiré.



### Avertissement de la FCC

Les modifications apportées à l'appareil qui ne sont pas expressément approuvées par le fabricant peuvent révoquer votre droit d'utiliser l'appareil en vertu des règles de la FCC.

### Conformité aux normes de sécurité

Cet appareil est conforme à la norme de sécurité suivante :

IEC 60601-1 Appareils électromédicaux - Section 1 : Exigences générales pour la sécurité de base et les performances essentielles.

### Conformité CEM

Cet appareil est conforme à la norme CEM suivante :

IEC 60601-1-2 Appareils électromédicaux - Section 1-2 : Exigences générales pour la sécurité de base et les performances essentielles - Norme collatérale : phénomènes électromagnétiques - Exigences et essais.

### Conformité ANATEL

Cet appareil est conforme à la résolution ANATEL n° 242/2000 sous le numéro ANATEL 02563-15-06534.

### Conformité CSA

Cet appareil est conforme à la norme CSA suivante pour le Canada et les États-Unis : UL Std No. 60601-1 - Appareils électromédicaux - Section 1 : Règles générales de sécurité.



## Nature du rayonnement émis par le scanner – French

- **Rayonnement électromagnétique (EMR)** - Lorsqu'il est utilisé conformément aux instructions, le niveau de rayonnement électromagnétique du scanner iTerO est similaire à celui d'un ordinateur personnel et est conforme à la norme internationale IEC 60601-1-2.
- **Rayonnement laser et LED** - Lorsqu'il est utilisé conformément aux instructions, le niveau de rayonnement laser et LED du scanner iTerO est incapable de causer des dommages aux yeux ou à d'autres tissus humains et est conforme aux normes internationales IEC 62471 et IEC 60825-1.

## Symboles – French

Les symboles suivants peuvent apparaître sur les composants électroniques iTerO Element 5D et iTerO Element 5D Plus peuvent apparaître dans ce document et dans d'autres documents iTerO Element.



Suivre le mode d'emploi.



Pièce appliquée de BF.



Une collecte séparée des déchets électriques et des équipements électroniques est requise. Conformément à la directive européenne sur les déchets d'équipements électriques et électroniques (DEEE), ne jetez pas ce produit avec les déchets ménagers ou urbains. Cet appareil contient des matériaux DEEE.

Veuillez contacter le service EARN.

Lien vers le formulaire de demande en ligne :  
<http://b2btool.earn-service.com/aligntech/select>



**Attention** Partout où ce symbole apparaît sur l'appareil, il est obligatoire de se référer aux informations relatives à la sécurité contenues dans ce document.



Ne pas réutiliser.

## "Rx only"

**ATTENTION** : La loi fédérale américaine limite la vente de cet appareil par ou pour le compte d'un dentiste, d'un orthodontiste ou d'un professionnel dentaire agréé. Le système constitue un dispositif médical sur ordonnance et ne doit être manipulé que par des professionnels de santé qualifiés.



Fabricant du dispositif médical.



Référence catalogue.



Numéro de série.



Courant alternatif.



Conserver au sec.



Code du lot



Limite de pression atmosphérique



Limite d'humidité



Fragile, à manipuler avec soin.



Ce côté doit être placé vers le haut.



IEC 60417-5031 : Courant continu.



Tige (unité de numérisation).



Identifiant unique de l'appareil



Pays de fabrication (y compris la date de fabrication).



Limite de température.



Dispositif médical.



Consultez les instructions d'utilisation électroniques.



Prise USB.



Batterie électrique.



IEC 60417-5009 : EN ATTENTE.



Montée interdite.



Représentant autorisé dans la Communauté Européenne.



Conforme RoHS pour la Chine.



Marquage CE.

## Consignes de sécurité – French

Avant de commencer à travailler avec le système, tous les utilisateurs doivent prendre connaissance de ces consignes de sécurité.

### Alimentation électrique

Le système est alimenté via une batterie interne de qualité médicale. Dans iTerro Element 5D Plus les scanners de configuration de chariot, l'alimentation électrique est placée dans la base du support de roue. Dans les scanners de configuration mobile, l'alimentation électrique est externe.

### Puissance de la batterie

- Charge - la batterie du scanner sera complètement chargée après avoir été branchée à une source d'alimentation pendant 2 h (iTerro Element 5D) ou 2.5 h (iTerro Element 5D Plus).
- Avec une batterie complètement chargée, vous pouvez numériser jusqu'à 30 minutes à l'aide du scanner de configuration desupport de roue ou 10 minutes à l'aide du scanner de configuration mobile.

**Avertissement:** Les scanners de la configuration chariot sont fournis avec deux packs de batteries rechargeables Li-ion et les scanners de configuration mobiles sont fournis avec un pack de batteries. Il existe un risque d'explosion de la batterie si l'écran est endommagé. N'utilisez pas le scanner en cas de chute ou si des dommages sont constatés. Contactez le service clients.

- Utilisez uniquement l'adaptateur CA/CC d'origine connecté au système pour charger les batteries.
- **Avertissement:** Une batterie Li-ion défaillante commence à siffler, à gonfler et à laisser fuir des électrolytes. Les électrolytes sont constitués de sel de lithium dans un solvant organique (hexafluorophosphate de lithium), qui est très inflammable. La combustion d'électrolytes peut enflammer des matériaux combustibles à proximité immédiate.

Attention, il y a un risque de brûlure associé à cette situation.

- L'écran doit être stocké et utilisé conformément aux conditions environnementales indiquées dans ce manuel. N'exposez pas le scanner à des sources de chaleur extrêmes, telles que des radiateurs et des cheminées.
- N'utilisez jamais l'appareil sans batteries! N'utilisez pas les batteries à des fins autres que l'usage prévu du produit. Jetez les batteries usagées conformément aux instructions du fabricant et aux exigences locales.
- Remplacez les batteries uniquement avec le même type de batterie fournie par Align.

### Avertissements électriques

- Ne retirez pas les panneaux ni les couvercles externes afin d'éviter les chocs électriques. L'appareil ne contient aucune pièce remplaçable par l'utilisateur. Pour les scanners iTerro Element 5D Plus, vous pouvez ouvrir le capot du panneau de diagnostic en cas de défaillance du système uniquement lorsque le service clients le demande.
- Ne connectez pas le scanner à une alimentation principale sans prise de terre, afin d'éviter tout risque d'électrocution.

**iTero Element 5D laptop configuration:**

- Le iTero Element 5D laptop-configuration scanner est fourni avec un hub contenant l'alimentation de la tige. Ne placez pas le système sur une surface mouillée et ne marchez pas dessus, afin d'éviter tout risque d'endommagement du système et d'électrocution.
  - Ne connectez jamais le concentrateur à un ordinateur portable qui n'est pas approuvé selon CEI 60950-1 ou CEI 62368-1, selon le cas. L'ordinateur portable et tous ses accessoires doivent être situés à au moins 1,5 m du patient. Ne numérisez pas un patient en même temps que vous touchez l'ordinateur portable ou l'un de ses accessoires. Le non-respect de ces instructions peut entraîner un choc électrique.
- Précautions électriques**
- Ne connectez pas une webcam non approuvée par Align aux prises USB à l'arrière de l'écran tactile, afin d'éviter tout risque de choc électrique.
  - Ne connectez rien d'autre que la tige iTero aux prises USB du hub.
  - Ne connectez pas de câble d'alimentation qui n'est pas fourni par Align Technology afin d'éviter tout choc électrique.
- Réseau local sans fil**
- Le système est équipé d'une unité de réseau local sans fil.
  - Lors de l'utilisation du produit, maintenez une distance d'au moins 20 cm entre l'unité de calcul et le corps de toutes les personnes pour garantir la conformité aux exigences d'exposition aux RF.
- Classifications de sécurité**
- Type de protection contre les chocs électriques : Classe 1.
  - Degré de protection contre les chocs électriques : Type BF.
  - Degré de protection contre les infiltrations d'eau dangereuses : Ordinaire.
  - L'équipement ne convient pas à une utilisation en présence de mélanges anesthésiques inflammables.
  - Mode de fonctionnement : En continu.
- Dispositif médical sur ordonnance**
- Le système constitue un dispositif médical sur ordonnance et ne doit être manipulé que par des prestataires de soins qualifiés.
- Précautions relatives au scanner**
- La tige émet une lumière laser rouge (680 nm classe 1) ainsi que des émissions LED blanches et des émissions LED 850nm. L'utilisation normale de la tige ne présente aucun danger pour l'œil humain. Évitez de diriger la lumière de la tige directement dans les yeux du patient.
  - Évitez de tordre, de nouer, de tirer ou de marcher sur le câble de la tige et le câble d'alimentation.
  - Lorsque le système n'est pas utilisé, la tige doit être placée dans le socle avec la surface optique en face du socle, afin d'éviter tout contact visuel avec le faisceau laser, émission de LED blanche clignotante, et l'émission de LED 850nm. Le contact avec les yeux peut leur causer des dommages.
  - Évitez d'activer la tige lorsque la pointe de la tige est en dehors de la bouche du patient, afin d'éviter des lésions oculaires.
  - Évitez de placer la tige dans le socle pendant que l'opération de numérisation est toujours active, afin d'éviter des lésions oculaires.

	<ul style="list-style-type: none"><li>• N'utilisez pas l'équipement en cas de dysfonctionnement du scanner ou si des dommages physiques sont constatés, afin d'éviter tout choc électrique ou blessure physique. Appelez le Service clientèle.</li></ul>
<b>Nettoyage &amp; désinfection</b>	<p>Pour éviter la contamination croisée, il est obligatoire de :</p> <ul style="list-style-type: none"><li>• Nettoyer et désinfecter la tige, comme décrit dans <a href="#">Cleaning and disinfecting the wand</a>, et remplacer le wand sleeve, comme décrit dans <a href="#">Applying a wand sleeve</a>, avant chaque session patient.</li><li>• Enlever et remplacer les gants après chaque séance avec un patient.</li><li>• Jeter les gants déchirés, contaminés ou déjà enlevés.</li><li>• Changer la wand sleeve entre chaque patient. Ne pas changer la wand sleeve entre les patients peut entraîner le transfert par inadvertance de micro-organismes et d'autres contaminants d'un patient à un autre.</li><li>• Jeter les wand sleeves conformément aux procédures d'utilisation standard ou aux réglementations locales relatives à l'élimination des déchets médicaux contaminés.</li></ul>
<b>Déballage &amp; installation</b>	<p>Le système doit être déballé et installé conformément aux instructions fournies par Align Technology, décrites dans <a href="#">Assembly instructions</a>.</p> <p><b>Remarque:</b> contactez le service client si la boîte du scanner est endommagée ou si l'indicateur ShockDot sur la boîte a été activé.</p>
<b>Environnement de travail</b>	<ul style="list-style-type: none"><li>• Le système doit être déplacé d'une pièce à une autre avec le plus grand soin pour éviter de l'endommager.</li><li>• N'obstruez pas les orifices d'aération de la tige et de l'unité informatique.</li><li>• Le système est conçu pour une utilisation en intérieur uniquement. Il ne doit pas être exposé directement à la lumière du soleil, à une chaleur excessive ou à l'humidité.</li><li>• iTerO Element 5D laptop configuration seulement: si le système vient juste d'être déplacé dans un endroit en provenance d'un environnement chaud, froid ou humide, laissez le matériel s'adapter à la température ambiante pour éviter la condensation interne.</li></ul>
<b>Précaution contre les interférences électromagnétiques</b>	<p>Cet appareil a été testé et approuvé conformément aux exigences des dispositifs médicaux selon la norme IEC60601-1-2. Cette norme est conçue pour fournir une protection raisonnable contre les interférences dangereuses dans une installation médicale classique.</p> <p>Évitez de placer cet appareil à proximité d'équipements de transmission de fréquence ou d'autres sources d'interférences électriques et électromagnétiques (par exemple, téléphones portables, radios mobiles bidirectionnelles, appareils électriques, RFID). Des niveaux élevés de telles interférences, dus à la proximité ou à la force de la source, peuvent entraîner une perturbation des performances de cet appareil. Dans ce cas, l'appareil peut être remis en mode de fonctionnement après une intervention de l'utilisateur ou par une récupération automatique.</p>
<b>Informations générales</b>	<p><b>Remarques:</b></p> <ul style="list-style-type: none"><li>• N'apportez aucune modification à cet équipement.</li><li>• Configurations chariot et support à roue uniquement: Ne retirez pas l'unité de traitement du support après l'assemblage.</li></ul>



**Notification  
d'incident**

Tout incident grave lié à l'appareil iTero doit être signalé à Align Technology Ltd. et à l'autorité compétente du pays dans lequel l'utilisateur et le patient sont établis.



## Table of contents

<b>1</b>	<b>Introduction to iTero Element 5D and iTero Element 5D Plus imaging systems</b>	<b>1</b>
1.1	Intended purpose/Intended use	2
1.2	Indications for use	2
1.3	Contraindications	2
1.4	Intended patient population	2
1.5	Intended users	2
1.6	Use environment	2
1.7	Clinical benefits	3
1.8	iTero Element 5D and iTero Element 5D Plus hardware	4
1.8.1	iTero Element 5D wheel-stand configuration	5
1.8.2	iTero Element 5D laptop configuration	6
1.8.3	iTero Element 5D Plus cart configuration	7
1.8.4	iTero Element 5D Plus mobile configuration	8
1.8.5	iTero Element 5D wand	9
1.9	iTero Element 5D, iTero Element 5D Plus, and 5D Plus Lite software	10
1.10	Working with iTero near infra-red imaging (NIRI) technology	11
1.10.1	iTero NIRI technology limitations	13
1.11	About this manual	13
<b>2</b>	<b>Assembly instructions</b>	<b>14</b>
2.1	Assembling the iTero Element 5D wheel-stand configuration scanner	15
2.2	Assembling the iTero Element 5D laptop-configuration scanner	19
2.2.1	Installing the iTero Element 5D software – laptop configuration	19
2.3	Assembling the iTero Element 5D Plus and 5D Plus Lite scanner – cart configuration	21
2.4	Assembling the iTero Element 5D Plus and 5D Plus Lite scanner – mobile configuration	26
2.4.1	Initial assembly	27
2.4.2	Moving the scanner within the clinic	29
2.4.3	Using the trolley for transportation	29
2.4.4	Optional protective trolley cover	32
2.4.5	VESA mounting	32
<b>3</b>	<b>Getting started</b>	<b>35</b>
3.1	Logging in to the scanner for the first time	35
3.2	Registering the scanner – Make It Mine process	35

<b>4</b>	<b>Working with the scanner</b>	<b>42</b>
4.1	Logging in to the scanner	42
4.1.1	Resetting your password	46
4.1.2	Installing Windows security updates	48
4.2	Logging out of the scanner	53
4.3	Shutting down the scanner	54
4.4	Moving the scanner	54
4.4.1	Moving the iTerо Element 5D wheel-stand configuration scanner	54
4.4.2	Transporting the iTerо Element 5D laptop-configuration imaging system	54
4.4.3	Moving the iTerо Element 5D Plus cart-configuration scanner	55
4.4.4	Carrying the iTerо Element 5D Plus mobile-configuration scanner within the clinic	56
4.4.5	Transporting the iTerо Element 5D Plus mobile-configuration scanner between clinics	57
4.5	User interface	58
4.5.1	Scanner toolbar	61
4.5.2	Touch-screen gestures	64
4.6	Defining the scanner settings	65
4.6.1	Defining the Device settings	66
4.6.2	Defining the User settings	70
4.6.3	Defining the System settings	78
<b>5</b>	<b>Starting a new scan</b>	<b>84</b>
5.1	Applying a wand sleeve	84
5.2	Starting the scanning process	85
5.3	Filling in the Rx	87
5.3.1	Filling in the Rx for Study Model/iRecord procedures	90
5.3.2	Filling in the Rx for Invisalign procedures	91
5.3.3	Filling in the Rx for Fixed Restorative procedures	93
5.3.4	Filling in the Rx for Implant Planning procedures	106
5.3.5	Filling in the Rx for Denture/Removable procedures	109
5.3.6	Filling in the Rx for Appliance procedures	113
5.3.7	Disabling NIRI data capture	114
5.3.8	Confirming a new wand sleeve between patients	116
5.4	Patient management	118
5.4.1	Adding new patients	118
5.4.2	Searching for existing patients	119
5.4.3	Editing the patient details	121

5.4.4	Clearing the patient details from the New Scan window .....	123
5.5	Scanning the patient .....	124
5.5.1	Scanning guidance .....	125
5.5.2	Scanning best practices .....	126
5.5.3	Scan options .....	126
5.5.4	Toggling the 3D and viewfinder display .....	129
5.5.5	Toggling between color and NIRI images in the viewfinder .....	131
5.5.6	Editing a scan .....	131
5.6	Viewing the scan .....	132
5.6.1	Missing scan segment notifications .....	133
5.6.2	Using the scan timer .....	135
5.7	Sending the scan .....	135
5.8	Working with the Viewer .....	139
5.9	Removing the wand sleeve .....	142
<b>6</b>	<b>Working with patients .....</b>	<b>144</b>
6.1	Searching for patients .....	144
6.2	Viewing the patient details .....	146
6.3	Creating a new scan for a specific patient .....	147
6.4	Viewing the Rx .....	149
6.5	Viewing previous scans in the Viewer .....	150
<b>7</b>	<b>Working with orders .....</b>	<b>152</b>
7.1	Working with returned orders .....	155
<b>8</b>	<b>Viewing messages .....</b>	<b>156</b>
<b>9</b>	<b>Working with MyiTero .....</b>	<b>157</b>
<b>10</b>	<b>iTero scanner features and tools .....</b>	<b>158</b>
10.1	Comparing previous scans using iTero TimeLapse technology .....	158
10.2	Invisalign Outcome Simulator Pro .....	162
10.3	Invisalign Outcome Simulator .....	162
10.4	Invisalign Progress Assessment .....	162
10.5	Invisalign Go system .....	163
10.6	Editing tools .....	163
10.6.1	Deleting a segment .....	164
10.6.2	Deleting a selection .....	166
10.6.3	Filling in missing anatomy .....	168
10.6.4	Disabling auto-cleanup .....	169

10.7	Working with the Eraser tool .....	171
10.8	Working with the Occlusal Clearance tool .....	173
10.9	Working with the Edge Trimming tool .....	177
10.10	Working with the Die Separation tool .....	179
10.11	Working with the Margin Line tool .....	183
10.11.1	Automatically defining the margin line .....	183
10.11.2	Manually defining the margin line .....	185
10.12	Working with the Review tool (iTerо Element 5D and 5D Plus) .....	185
10.12.1	Zooming in to and out of the images in the image pane .....	187
10.12.2	Adjusting the brightness and contrast of images in the image pane .....	189
10.12.3	Capturing the Review tool images .....	190
10.13	Working with the Review tool (iTerо Element 5D Plus Lite) .....	190
10.13.1	Zooming in to and out of the images in the image pane .....	192
10.13.2	Adjusting the brightness and contrast of images in the image pane .....	194
10.13.3	Capturing the Review tool images .....	195
10.14	Working with the Snapshot tool .....	196
<b>11</b>	<b>Care and maintenance .....</b>	<b>202</b>
11.1	Handling the wand and cable .....	202
11.2	Cleaning and disinfecting the wand .....	202
11.2.1	Preparation before cleaning and disinfection .....	203
11.2.2	Wand cleaning and disinfection .....	204
11.2.3	Drying – wand body .....	205
11.2.4	Storage and maintenance .....	205
11.3	Cleaning and disinfecting the cradle .....	206
11.3.1	Preparation before cleaning and disinfection .....	206
11.3.2	Cradle cleaning and disinfection .....	207
11.3.3	Drying – cradle .....	208
11.3.4	Storage and maintenance .....	209
11.4	Cleaning and disinfecting the scanner touch screen and the wheel-stand handle .....	209
11.5	General cleaning .....	209
11.6	Approved cleaning and disinfecting materials .....	210
<b>A</b>	<b>Clinic LAN network guidelines .....</b>	<b>211</b>
A.1	Introduction .....	211
A.2	Preparations .....	211
A.3	Router guidelines .....	212

A.4	Internet connection guidelines .....	212
A.5	Firewall .....	212
A.6	Wi-Fi tips .....	212
A.7	Align hostname recommendations .....	213
<b>B</b>	<b>EMC declarations .....</b>	<b>214</b>
B.1	EMC declaration – iTero Element 5D .....	214
B.2	EMC declaration – iTero Element 5D Plus .....	217
<b>C</b>	<b>iTero Element product security whitepaper .....</b>	<b>220</b>
<b>D</b>	<b>System specifications .....</b>	<b>223</b>
D.1	iTero Element 5D wheel-stand configuration system specifications .....	224
D.2	iTero Element 5D laptop-configuration system specifications .....	225
D.3	iTero Element 5D Plus system specifications .....	226

## Table of figures

Figure 1: Front view of the iTerо Element 5D imaging system .....	5
Figure 2: Rear view of the iTerо Element 5D imaging system .....	6
Figure 3: iTerо Element 5D laptop-configuration imaging system .....	6
Figure 4: Front view of the iTerо Element 5D Plus cart-configuration imaging system .....	7
Figure 5: Rear view of the iTerо Element 5D Plus cart-configuration imaging system .....	8
Figure 6: Front view of the iTerо Element 5D Plus mobile-configuration imaging system .....	8
Figure 7: Rear view of the iTerо Element 5D Plus mobile-configuration imaging system .....	9
Figure 8: iTerо Element 5D wand .....	9
Figure 9: Protective sleeve .....	10
Figure 10: Disposable sleeve .....	10
Figure 11: Visible light spectrum showing NIRI on the 850nm wavelength .....	11
Figure 12: Reflective concept – healthy enamel is translucent while dentin and caries are reflective .....	11
Figure 13: Interproximal carious lesion .....	12
Figure 14: Removing the wand from the cradle .....	25
Figure 15: Moving the scanner .....	25
Figure 16: Do not lift the scanner using the main handle .....	25
Figure 17: Do not allow the power pack to dangle in the air .....	34
Figure 18: Never tilt the screen more than 45 degrees .....	34
Figure 19: Welcome screen .....	35
Figure 20: Connect page listing the available networks .....	36
Figure 21: Entering the security key .....	36
Figure 22: Scanner is connected to the Internet and online .....	37
Figure 23: Verifying the communication with Align .....	37
Figure 24: Selecting the time zone .....	38
Figure 25: Registering the system to customize the setup .....	38
Figure 26: Example of an iTerо subscription package .....	39
Figure 27: License agreement .....	39
Figure 28: Checking for updates .....	40
Figure 29: System is registered and ready .....	40
Figure 30: Login window .....	42
Figure 31: Unexpected shutdown notification .....	43
Figure 32: Password is masked .....	44



Figure 33: iTero home screen .....	45
Figure 34: Forgot Password button .....	46
Figure 35: Email field for forgotten password .....	46
Figure 36: Security answer field .....	47
Figure 37: Security Updates window - scheduling options .....	48
Figure 38: Connect the scanner to the AC power .....	49
Figure 39: Installation in progress .....	49
Figure 40: Installation completed successfully .....	50
Figure 41: Security updates – number of days until the updates must be installed .....	50
Figure 42: Security updates – last day .....	51
Figure 43: Security updates notification – Login window .....	52
Figure 44: Security updates notification – home screen .....	53
Figure 45: iTero Element 5D laptop-configuration imaging system in the supplied carrying case .....	55
Figure 46: Moving the scanner .....	56
Figure 47: Carrying the scanner between rooms within the clinic .....	57
Figure 48: Transporting the scanner between clinics .....	57
Figure 49: iTero home screen .....	58
Figure 50: Percentage of remaining battery charge .....	59
Figure 51: Help overlay including the e-manual and Customer Support buttons .....	60
Figure 52: Scanner toolbar .....	61
Figure 53: Percentage of remaining battery charge .....	62
Figure 54: Help overlay including e-manual and Customer Support buttons .....	63
Figure 55: Settings window .....	65
Figure 56: Brightness settings .....	66
Figure 57: Volume settings .....	66
Figure 58: List of nearby Wi-Fi networks .....	67
Figure 59: Connecting to the clinic Wi-Fi network .....	68
Figure 60: Forgetting or Disconnecting from the network .....	68
Figure 61: Time zone settings .....	69
Figure 62: Scan Settings window .....	70
Figure 63: Only the scanning range is highlighted .....	72
Figure 64: Rx Settings window .....	73
Figure 65: Rx Settings window – NIRI Captures option enabled .....	75
Figure 66: Disable NIRI confirmation .....	75
Figure 67: Rx Settings window – NIRI Captures option disabled .....	76

Figure 68: Signature Settings window .....77

Figure 69: Language Settings window ..... 78

Figure 70: Login Settings window ..... 79

Figure 71: Diagnostics window ..... 80

Figure 72: Licensing Information window ..... 81

Figure 73: System Information window – iTero Element 5D Plus .....82

Figure 74: Export Settings window – deleting exported files .....83

Figure 75: Gently slide the new sleeve into place ..... 84

Figure 76: New Scan window showing an empty Rx form and progress toolbar .....85

Figure 77: New Scan window – iTero Element 5D Plus Lite ..... 86

Figure 78: New Scan window ..... 88

Figure 79: Selecting the required procedure .....89

Figure 80: Order and Scan Options areas – Study Model/iRecord procedure .....91

Figure 81: Order area – Invisalign procedure .....92

Figure 82: Scan Options and Tooth Diagram areas – Fixed Restorative procedure ..... 94

Figure 83: List of fixed restorative treatment options .....95

Figure 84: Treatment settings window – Onlay restoration ..... 95

Figure 85: Selected tooth and Treatment Information area – Onlay restoration .....96

Figure 86: Treatment settings window – Crown restoration ..... 97

Figure 87: Additional information area – Crown restoration ..... 98

Figure 88: Selected tooth and Treatment Information area – Crown restoration ..... 99

Figure 89: Copy restoration settings from a tooth requiring the same treatment type .....99

Figure 90: Treatment settings window – Implant Based restoration ..... 100

Figure 91: Expanded Restoration Type area .....101

Figure 92: Expanded Crown area .....101

Figure 93: Treatment settings window – Bridge restoration .....102

Figure 94: Bridge range and teeth to be included .....102

Figure 95: List of in-bridge treatment options ..... 103

Figure 96: Bridge. restoration – Pontic settings ..... 103

Figure 97: Additional information area – Bridge restoration .....104

Figure 98: Bridge treatment options – Implant Based .....105

Figure 99: Expanded Restoration Type area .....105

Figure 100: Expanded Crown area .....106

Figure 101: Implant Planning procedure types ..... 106

Figure 102: Implant Planning procedure – Tooth Diagram for Surgical Guide Tooth Supported .....107

Figure 103: Defining the teeth that need to be implanted .....	108
Figure 104: Implant Position window .....	108
Figure 105: Supporting teeth and teeth to be implanted displayed in the Tooth Diagram and Treatment Information areas .....	109
Figure 106: Denture/Removable procedure types .....	110
Figure 107: Scanning option for scanning both the dentures and the patient .....	111
Figure 108: Defining the teeth to be included in the denture – Full Denture Implant Based procedure type .....	111
Figure 109: Implant Based settings window .....	112
Figure 110: Appliance procedure types .....	113
Figure 111: Disabling NIRI data capture for a specific scan .....	114
Figure 112: Scan tool without the option to display NIRI data in the viewfinder or to enlarge the viewfinder .....	115
Figure 113: Review tool is not displayed in View mode .....	115
Figure 114: Confirming that a new sleeve is attached .....	116
Figure 115: Popup confirmation message before scanning .....	117
Figure 116: Adding a new patient .....	118
Figure 117: Message notifying that a patient with the same details exists .....	119
Figure 118: Patient area of the New Scan window – searching for an existing patient .....	119
Figure 119: Search Patient window with a search field .....	120
Figure 120: Search criteria in the search field and list of matching patients .....	120
Figure 121: Selecting the required patient .....	121
Figure 122: Selected patient displayed in the Patient area of the New Scan window .....	121
Figure 123: Patient area of New Scan window – editing a patient .....	122
Figure 124: Edit Patient window and Update button .....	122
Figure 125: Message that a patient with the same details already exists .....	123
Figure 126: Clear patient details button .....	123
Figure 127: Clear confirmation message .....	124
Figure 128: Recommended scanning sequence – lower jaw .....	125
Figure 129: Wand guidance .....	126
Figure 130: Areas with missing anatomy shown with and without additional scan feedback – monochrome .....	127
Figure 131: Areas with missing anatomy shown with and without additional scan feedback – color mode .....	127
Figure 132: Model displayed in color and monochrome mode .....	128
Figure 133: Tap the opposite arch or tap the arrows to select it .....	129
Figure 134: Default view – 3D scan in the center of the window and viewfinder on the left .....	130
Figure 135: Large viewfinder in the center of the screen and 3D image on the left .....	130
Figure 136: Viewfinder displaying a color image (left) or a NIRI image (right) .....	131

Figure 137: Editing tools .....	132
Figure 138: Missing scan message and missing segments highlighted in red .....	134
Figure 139: Scan timer button on the toolbar and scan time .....	135
Figure 140: Notification about missing treatment information .....	136
Figure 141: Missing fields highlighted in red in the Treatment Information area .....	136
Figure 142: Send Confirmation window .....	137
Figure 143: Invisalign Outcome Simulator Pro progress shown in the Viewer .....	138
Figure 144: Invisalign Outcome Simulator Pro progress shown in the patient's profile page .....	138
Figure 145: Viewer option in the Past Orders pane in the Orders page .....	139
Figure 146: Viewer option in the patient's profile page .....	139
Figure 147: Model in a 1-window view .....	140
Figure 148: Model in a 2-window view .....	141
Figure 149: Model in a 5-window view .....	141
Figure 150: Removing a wand sleeve .....	142
Figure 151: Optical surface of the wand .....	143
Figure 152: Gently slide the new sleeve into place .....	143
Figure 153: Patients page .....	144
Figure 154: Searching for a patient .....	145
Figure 155: Patients matching the search criteria are displayed .....	145
Figure 156: Patient's profile page .....	146
Figure 157: Patient's profile page – New Scan option .....	147
Figure 158: New Scan window with patient's details already filled in .....	148
Figure 159: Patient's profile page – View Rx option .....	149
Figure 160: Rx Details window .....	150
Figure 161: Patient's profile page – Viewer option .....	151
Figure 162: Scan displayed in the Viewer .....	151
Figure 163: Orders page .....	153
Figure 164: In Progress pane – options .....	153
Figure 165: Past Orders pane – options .....	154
Figure 166: Orders button notifying a returned order .....	155
Figure 167: Returned order in the In Progress pane .....	155
Figure 168: Messages page .....	156
Figure 169: iTerio TimeLapse – selecting the scans to compare .....	159
Figure 170: iTerio TimeLapse window showing the highlighted changes between the scans .....	159
Figure 171: Area of interest from the first scan displayed in the animation window .....	160

Figure 172: Area of interest from the second scan displayed in the animation window .....	160
Figure 173: iTero TimeLapse scale options .....	161
Figure 174: Progress Assessment window .....	163
Figure 175: Editing tools .....	164
Figure 176: Delete Segment tool .....	165
Figure 177: Delete Selection tool .....	166
Figure 178: Expanded Delete Selection tool .....	167
Figure 179: Selected area of the anatomy is deleted .....	167
Figure 180: Fill tool .....	168
Figure 181: Areas that require scanning are highlighted in red – Fill tool .....	169
Figure 182: Auto-cleanup tool .....	170
Figure 183: Scan displayed with excess material showing .....	170
Figure 184: Eraser tool .....	171
Figure 185: Eraser tool options .....	171
Figure 186: Mark the area to be modified .....	172
Figure 187: Selected area removed, and scan tool enabled .....	172
Figure 188: Deleted area marked in red .....	173
Figure 189: Occlusal clearance between the opposing teeth .....	174
Figure 190: Occlusal Clearance range options .....	175
Figure 191: Occlusal Clearance tool and legend displayed in the Viewer .....	176
Figure 192: Edge Trimming tool .....	177
Figure 193: Edge Trimming tool options .....	177
Figure 194: Mark the area to be trimmed away .....	178
Figure 195: Selected area is highlighted, and the confirmation icon is enabled .....	178
Figure 196: Selected area has been removed .....	179
Figure 197: Green hint point centered on the prepped tooth .....	180
Figure 198: Die separation is displayed in high resolution .....	180
Figure 199: Die Separation tool options .....	181
Figure 200: Scan is displayed in low resolution .....	181
Figure 201: Before selecting the die separation .....	182
Figure 202: Prepped tooth is displayed in high resolution .....	182
Figure 203: Model display moves to the occlusal view, and zooms in on the prepped tooth .....	183
Figure 204: Margin Line tool options .....	184
Figure 205: Margin line is marked on the prepped tooth .....	184
Figure 206: Margin Line tool options .....	185

Figure 207: Review tool with the Snapshot tool on the toolbar and the loupe in the right pane .....	186
Figure 208: Image pane on the right showing the area of interest as both NIRI and colored intraoral images .....	187
Figure 209: Zoom-in buttons on the images in the image pane .....	188
Figure 210: Only the zoomed-in image is displayed in the enlarged image pane window .....	188
Figure 211: Brightness and contrast toolbar is collapsed .....	189
Figure 212: Brightness and contrast toolbars .....	190
Figure 213: Review tool with the Snapshot tool on the toolbar and the loupe in the right pane .....	191
Figure 214: Image pane on the right showing the area of interest .....	192
Figure 215: Zoom-in button on the image in the image pane .....	193
Figure 216: Zoomed-in image displayed in the enlarged image pane .....	193
Figure 217: Brightness and contrast toolbar is collapsed .....	194
Figure 218: Brightness and contrast toolbar .....	195
Figure 219: View mode – with Snapshot tool .....	197
Figure 220: Screen capture thumbnail is displayed after taking a screen capture .....	197
Figure 221: Screenshot with an annotations toolbar .....	198
Figure 222: Annotations toolbar .....	198
Figure 223: Adding text to the screenshot .....	199
Figure 224: Screenshot with annotations .....	199
Figure 225: Notification that the screenshots and annotations will be uploaded to MyiTero .....	200
Figure 226: Confirmation about the annotations being discarded .....	200
Figure 227: Notification that the screenshots will be uploaded to MyiTero .....	201
Figure 228: Option to download screenshots from the Orders page in MyiTero .....	201
Figure 229: Wand without a sleeve .....	203
Figure 230: Remove gross contaminants using CaviWipes1 .....	204
Figure 231: Remove marks and stains using a soft bristle brush .....	204
Figure 232: Wipe the optical surface of the wand with IPA .....	205
Figure 233: Wiping the iTerio Element 5D cradle .....	207
Figure 234: Wiping the iTerio Element 5D laptop-configuration cradle .....	207
Figure 235: Wiping the iTerio Element 5D Plus cart-configuration cradle .....	207
Figure 236: Wiping the iTerio Element 5D Plus mobile-configuration cradle .....	207
Figure 237: Brushing the iTerio Element 5D cradle .....	208
Figure 238: Brushing the iTerio Element 5D laptop-configuration cradle .....	208
Figure 239: Brushing the iTerio Element 5D Plus cart-configuration cradle .....	208
Figure 240: Brushing the iTerio Element 5D Plus mobile-configuration cradle .....	208

# 1 Introduction to iTero Element 5D and iTero Element 5D Plus imaging systems

The iTero Element 5D and iTero Element 5D Plus imaging systems combine:

- **3D scanning:** Recording and visualization of topographic 3D data and 2D imaging with an intraoral camera that eliminates the need for a second device while enhancing patient experience and communication.
- **iTero NIRI technology:** Aids you in the diagnostics and monitoring of interproximal carious lesions above the gingiva, as well as patient communication. No additional scans are needed. No harmful radiation. For more information on iTero NIRI technology, see [Working with iTero near infra-red imaging \(NIRI\) technology](#).

**Note:** iTero NIRI technology is not supported by iTero Element 5D Plus Lite systems.

The iTero Element 5D imaging systems come in two configurations – wheel stand and laptop.

The wheel-stand configuration offers an all-in-one system available on a monitor with a fully interactive, touch-screen display and an easy-to-use wand. The topography of a patient's teeth can be viewed on the screen as they are being scanned, and determining the degree of occlusion of the bite can be analyzed when the scan is completed.

iTero Element 5D can also be used as a wand-only configuration with any laptop that meets our minimum system requirements, giving you the ultimate in mobility and the freedom to provide dedicated care wherever you choose to see patients.

The iTero Element 5D Plus family of imaging systems is Align Technology's latest generation of intraoral scanners, which comes in two configurations – cart and mobile.

The bright full HD touch-screen display has wide visualization angles for an immersive and engaging experience and the powerful computing power enables a smoother and intuitive scanning experience. The ergonomics and elegance of the cart configuration will enhance your experience and elevate your practice brand image. The mobile configuration, with its dedicated trolley, enables professional and convenient inter-office portability.

This all-in-one system is designed to take patient experience and your productivity to the next level, ultimately helping you to grow your practice while making things easier.

Refer to our website <http://www.itero.com> to learn how the iTero Service can enhance your business by increasing patient satisfaction and enhancing office efficiency.

## 1.1 Intended purpose/Intended use

The iTerio Element 5D and iTerio Element 5D Plus imaging systems are intraoral scanners with the following features and intended use:

- The optical impression (CAD/CAM) feature of the scanner is intended/indicated for use to record the topographical images of teeth and oral tissue. Data generated from iTerio may be used in conjunction with the production of dental devices (e.g. aligners, braces, appliances, etc.) and accessories.
- iTerio software is used with the iTerio scanner in capturing 3D digital impressions of teeth, oral soft tissue and structures, and bite relationship. The software controls the processing of the data, facilitating the integration of data, and exporting of the data for CAD/CAM fabrication of dental restorations, orthodontic devices, abutments, and accessories. In addition to scan data, various patient and case information can be imported/exported or used for simulation purposes. Other functions are available for verification and service of the system and to serve as an order management tool.
- The iTerio Element 5D NIRI functionality is a diagnostic aid for the detection of interproximal carious lesions above the gingiva and for monitoring the progress of such lesions.

## 1.2 Indications for use

iTerio Element scanners are indicated for use for orthodontic treatment planning and follow-up, restorative treatment planning and/or routine dental assessment.

## 1.3 Contraindications

For persons who have been diagnosed with Epilepsy, there is a risk of epileptic shock from the flashing light of the iTerio scanner. These persons should refrain from any eye contact with the flashing light associated with the system during operation.

## 1.4 Intended patient population

The system may be used on patients classified as Preadolescent, Adolescent, and Adult

## 1.5 Intended users

The system serves as a prescription medical device and should be operated by trained health-care providers only.

## 1.6 Use environment

Professional Healthcare and Home Healthcare Facility environment.



## 1.7 Clinical benefits

- Digital impressions improve patient comfort, accuracy, and speed of process as compared to conventional impressions.
- The iTero Element 5D and iTero Element 5D Plus imaging systems aid in the detection and monitoring of interproximal carious lesions above the gingiva without using harmful radiation.
- Non-ionizing radiation imaging provides clinical-assessment flexibility with frequent monitoring of interproximal carious lesions.

## 1.8 iTerо Element 5D and iTerо Element 5D Plus hardware

The iTerо Element 5D scanner is available in two models:

- [iTerо Element 5D wheel-stand configuration](#)
- [iTerо Element 5D laptop configuration](#)

Refer to <https://www.itero.com/our-solutions/itero-element-5d> for the minimum system requirements.

The iTerо Element 5D Plus scanner is available in two configurations:

- [iTerо Element 5D Plus cart configuration](#)
- [iTerо Element 5D Plus mobile configuration](#)

### 1.8.1 iTero Element 5D wheel-stand configuration

#### Front view of the system



- A Full HD Touch screen
- B Power switch
- C Power LED
- D Wand
- E Cradle
- F Wheel base

Figure 1: Front view of the iTero Element 5D imaging system

Rear view of the system



- A Wand connector
- B Wand cable
- C Screen power cable

Figure 2: Rear view of the iTero Element 5D imaging system

1.8.2 iTero Element 5D laptop configuration



- A Laptop touch screen
- B iTero Element 5D hub
- C Wand and cradle

Figure 3: iTero Element 5D laptop-configuration imaging system

### 1.8.3 iTero Element 5D Plus cart configuration

Front view



- A Full HD touchscreen
- B Power switch
- C Main handle
- D Wand
- E Cradle
- F Wheel stand

Figure 4: Front view of the iTero Element 5D Plus cart-configuration imaging system

Rear view

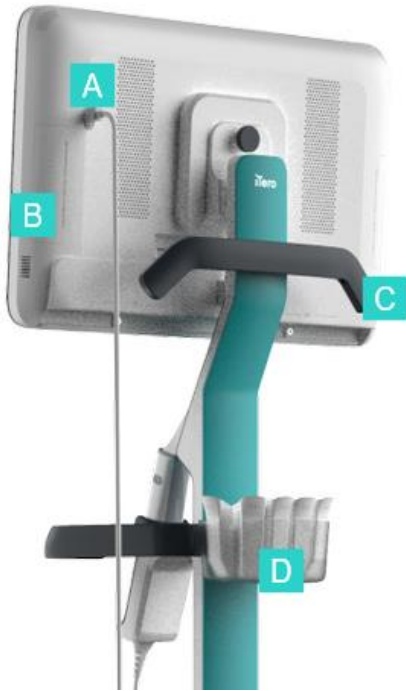

- A Wand connector
- B Diagnostics panel  
(for Support purposes only)
- C Upper handle
- D New-sleeve basket

Figure 5: Rear view of the iTero Element 5D Plus cart-configuration imaging system

1.8.4 iTero Element 5D Plus mobile configuration

Front view



- A Full HD touch-screen  
computing unit
- B Wand
- C Cradle

Figure 6: Front view of the iTero Element 5D Plus mobile-configuration imaging system

Rear view

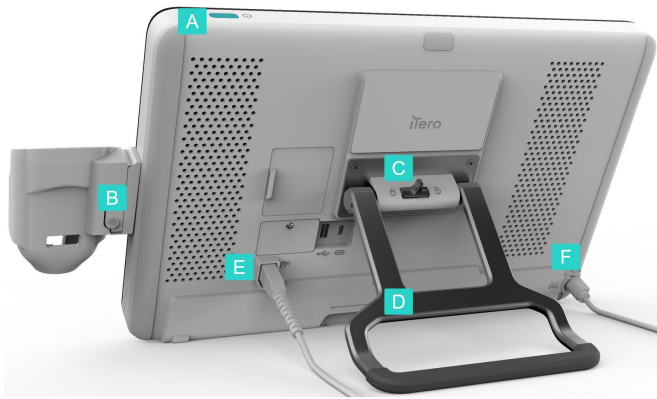

- A Power switch
- B Cradle release button
- C Locking latch
- D Carrying handle/stand
- E Wand cable
- F Power cable

Figure 7: Rear view of the iTero Element 5D Plus mobile-configuration imaging system

1.8.5 iTero Element 5D wand



- A Disposable sleeve
- B Touchpad
- C Side buttons: Scan, on/off, touchpad activation
- D Air vents
- E Detachable wand cable with USB connector

Figure 8: iTero Element 5D wand

**Note:** In order to protect the wand cable, the cable cap is designed to detach from the wand if too much pulling force is applied. If this happens, gently reattach the cable cap.

### 1.8.5.1 Wand sleeves

There are two types of wand sleeves:

- **Protective sleeve (blue)** Used when the scanner is not in use, to protect the optical surface of the wand.
- **Disposable sleeve:** Used while scanning. Before scanning the patient, attach a new disposable sleeve, as described in [Applying a wand sleeve](#).

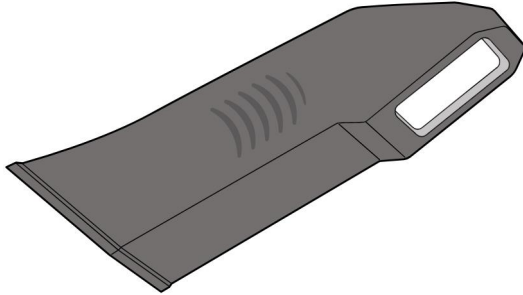

Figure 9: Protective sleeve

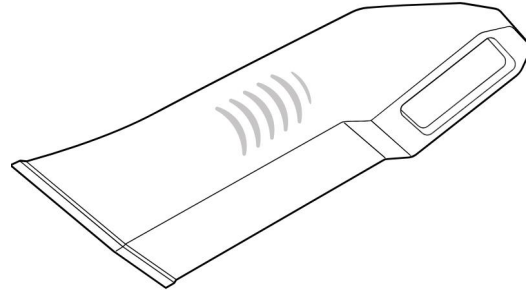

Figure 10: Disposable sleeve

## 1.9 iTerо Element 5D, iTerо Element 5D Plus, and 5D Plus Lite software

The iTerо Element 5D, iTerо Element 5D Plus, and 5D Plus Lite imaging systems contain the following exclusive software features:

- [Confirming a new wand sleeve between patients](#)
- [Toggling the 3D and viewfinder display](#)
- [Toggling between color and NIRI images in the viewfinder](#) – relevant for iTerо Element 5D and iTerо Element 5D Plus systems only
- [Working with the Review tool \(iTerо Element 5D and 5D Plus\)](#)

**Note:** iTerо NIRI technology is not supported by iTerо Element 5D Plus Lite systems.



## 1.10 Working with iTero near infra-red imaging (NIRI) technology

**Note:** This section is not relevant for iTero Element 5D Plus Lite systems.

NIRI is a method of spectroscopy that uses the near-infrared region of the electromagnetic spectrum (850nm).

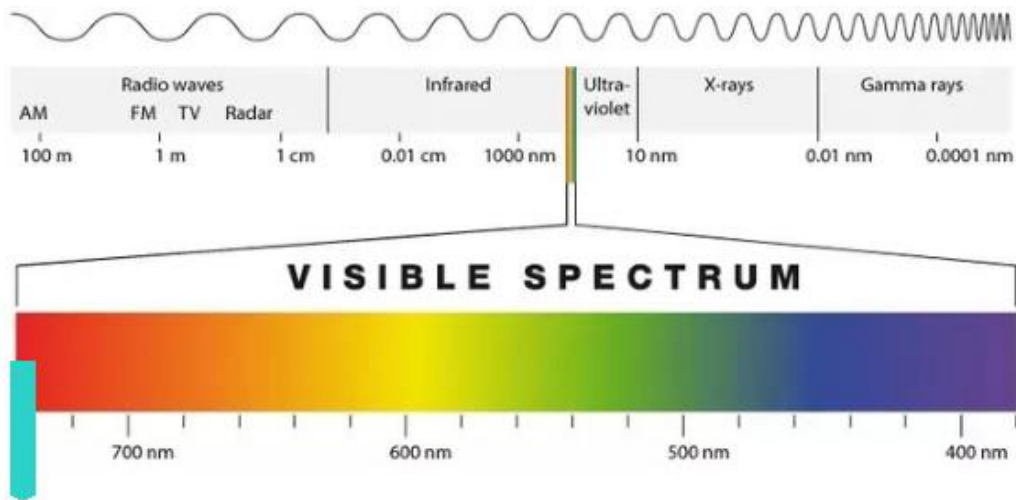

### NIRI

Figure 11: Visible light spectrum showing NIRI on the 850nm wavelength

When the wand is positioned above the tooth, NIR images are captured.

The translucency of the structure translates to the brightness level in the NIRI image – the higher the translucency, the darker the object, and vice versa. Tooth enamel is translucent to NIRI and will appear dark. Dentin and any interference in the enamel, e.g. caries, are reflective and cause the light to scatter, and therefore will appear brighter and opaque.

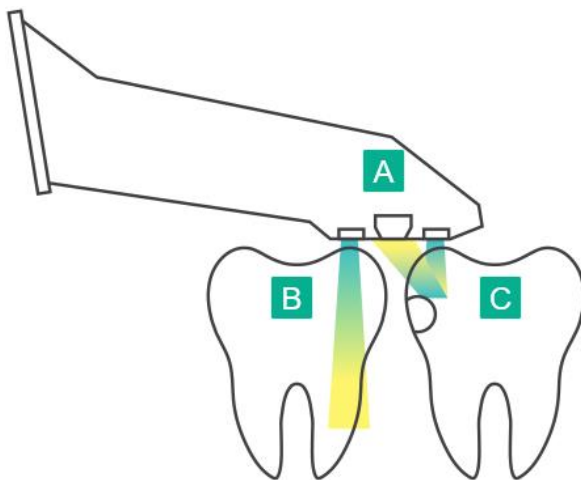

- A** Wand positioned on the tooth surface
- B** Tooth enamel is translucent
- C** Dentin and caries are reflective

Figure 12: Reflective concept – healthy enamel is translucent while dentin and caries are reflective

NIR images are captured automatically and seamlessly during the scan, from every angle used for the 3D scanning, and all collected information can then be reviewed using the iTerо Element 5D Review tool.

**Note:** NIR images should be used in conjunction with the current standard of care for caries detection, and do not replace it.

The resulting NIRI grayscale image shows structures with varying translucency as different levels of brightness. The lower the translucency, the higher the reflection of the infrared light and the brighter the structure. Using this technology, it is possible to make out the following structures:

	Appears	Translucency
<b>Enamel</b>	Dark	High
<b>Interproximal caries</b>	Bright	Low
<b>Dentin</b>	Bright	Low

The differentiation between carious lesions and dentin is based upon the location of the bright feature. Dentin is located in the center of a tooth, whereas interproximal carious lesions appear on the interproximal or distal mesial region, where healthy enamel is expected.

As such, dentin and interproximal carious lesions appear as bright features, with a dark enamel ring around the dentin structure, as shown in the figure below, which provides an occlusal view of a carious lesion.

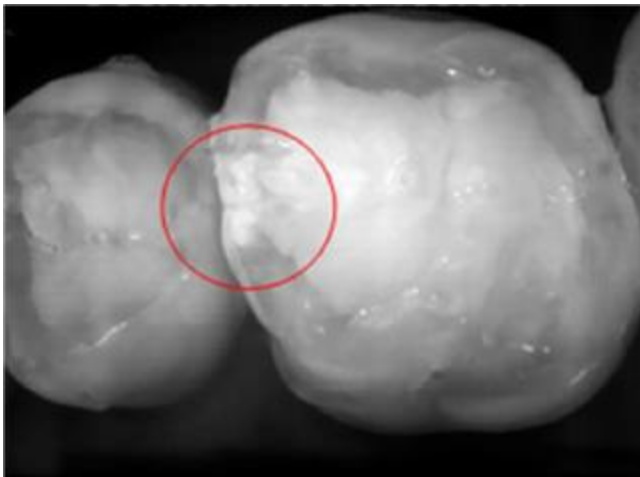

Figure 13: Interproximal carious lesion

### 1.10.1 iTero NIRI technology limitations

iTero NIRI technology has the following limitations:

- NIRI cannot detect caries below the gingiva, for example, to view caries in the roots of the teeth.
- NIRI cannot detect the progression of caries beyond the dentin-enamel junction (DEJ), which is the boundary between the enamel and the underlying dentin that forms the solid architecture of a tooth.
- Some restorations, e.g. crowns and amalgam fillings, are not translucent and may mask carious lesions below them.
- Highly opaque teeth have low translucency of the enamel making them appear brighter. This may cause difficulty in understanding the internal tooth structure, and differentiating between enamel and dentin, thereby affecting the ability to detect proximal caries.

For more information on using iTero NIRI technology, please refer to the *iTero Element 5D Clinical Guide*.

### 1.11 About this manual

This manual provides general information and an overview of the iTero Element 5D and iTero Element 5D Plus imaging systems and software. iTero Element 5D Plus imaging systems with the iTero Element 5D Plus Lite software package provide the same features and benefits as the iTero Element 5D Plus systems, including the 3D intraoral camera, but without the iTero NIRI functionality. All differences in the software are noted in this manual.

In addition, this manual describes how to assemble the system, install the software on iTero Element 5D laptop-configuration systems, start and shut down the system, clean and disinfect the system, and how to replace the wand sleeves between patients.

## 2 Assembly instructions

This section describes how to assemble your new scanner.

- [Assembling the iTerо Element 5D wheel-stand configuration scanner](#)
- [Assembling the iTerо Element 5D laptop-configuration scanner](#)
- [Assembling the iTerо Element 5D Plus and 5D Plus Lite scanner – cart configuration](#)
- [Assembling the iTerо Element 5D Plus and 5D Plus Lite scanner – mobile configuration](#)

## 2.1 Assembling the iTero Element 5D wheel-stand configuration scanner

Follow the instructions below to assemble the iTero Element 5D wheel-stand configuration scanner.



AC power



Battery



Click



DC power



Power button



Wand



2 people are required for installation

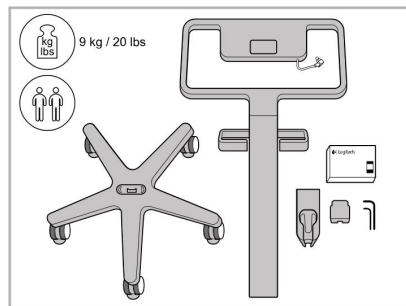
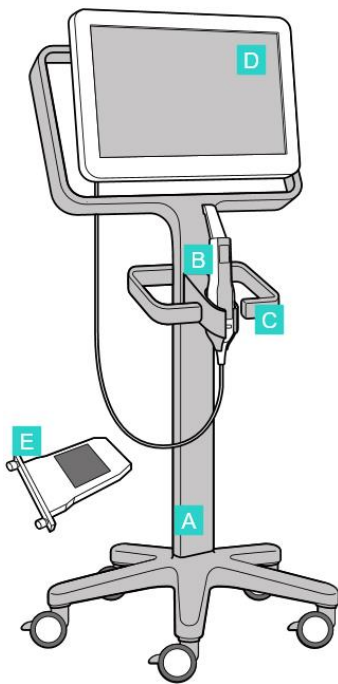

1. Check the contents of the boxes.

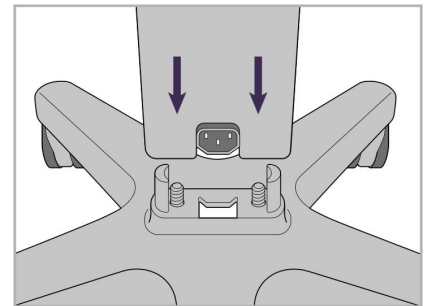

2. Connect the post to the wheel base.

- A Wheel stand
- B Wand with cable
- C Wand cradle
- D HD touch screen
- E External battery

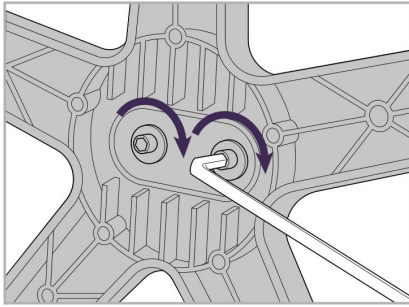

3. Tighten the two Allen screws using the larger Allen key.

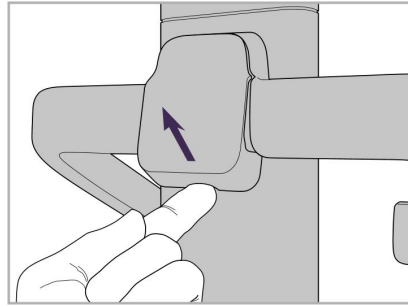

4. Remove the cover from the back of the handle.

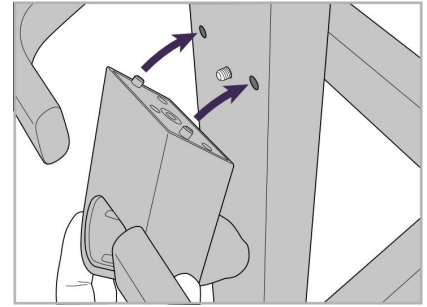

5. Attach the wand cradle to the front of the wheel stand.

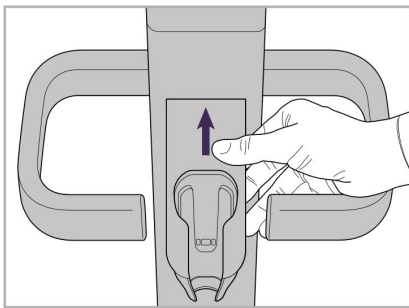

6. Hold the cradle.

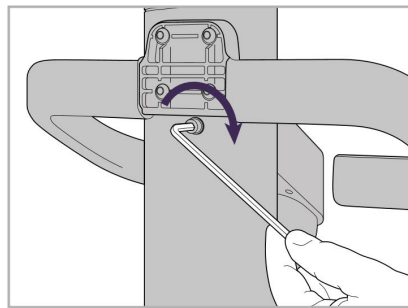

7. Tighten the back of the wand cradle with the Allen screw using the smaller Allen key.

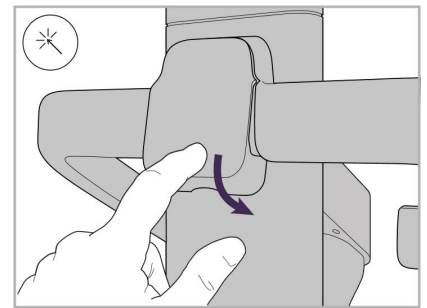

8. Reattach the cover behind the handle.

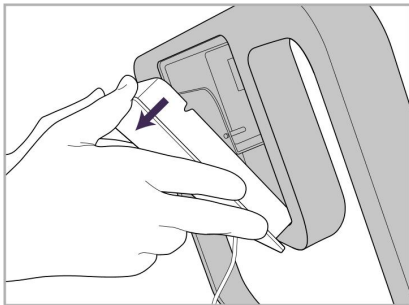

9. Remove the magnetic cover from the back of the wheel-stand frame.

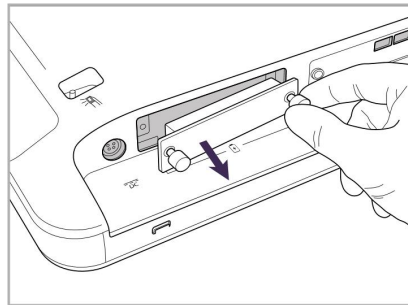

10. Loosen the thumbscrews and remove the battery cover.

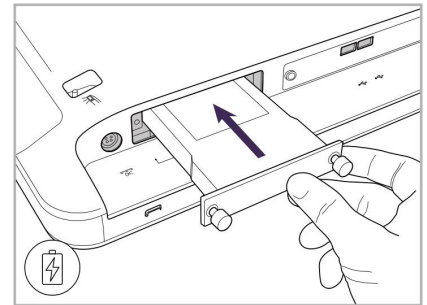

11. Slide the battery into the battery slot and tighten the thumbscrews.

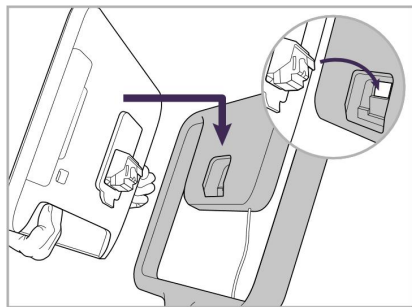

12. Lift the touch screen to mount it.

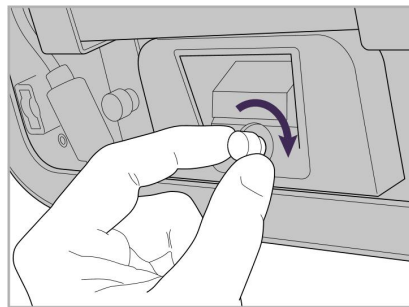

13. Turn the scanner around and tighten the thumbscrew to secure the screen.

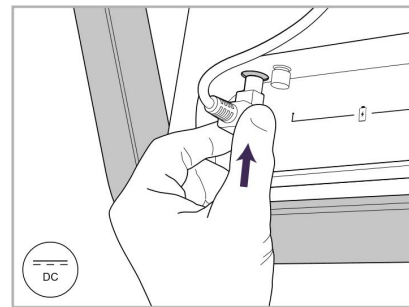

14. Connect the power cable to the port labeled DC, as shown in the next image.

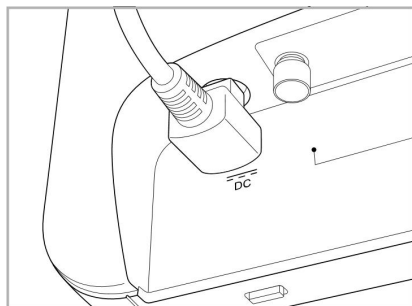

Power cable inserted.



15. Attach the magnetic back cover.

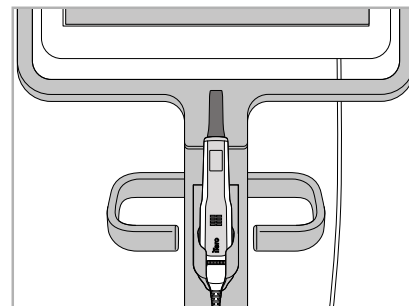

16. Place the wand in the cradle.

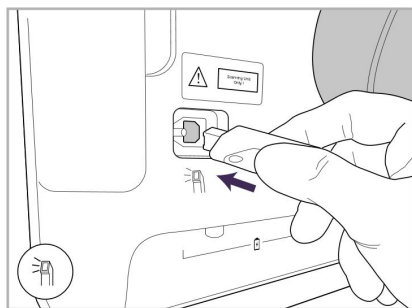

17. Connect the wand cable to the back of the touch screen.

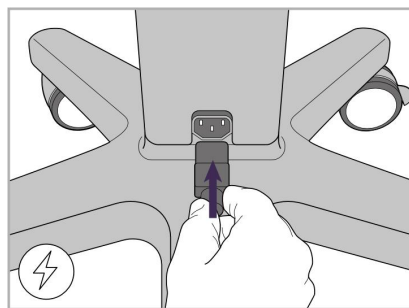

18. Connect the power cable on the bottom of the wheel stand.

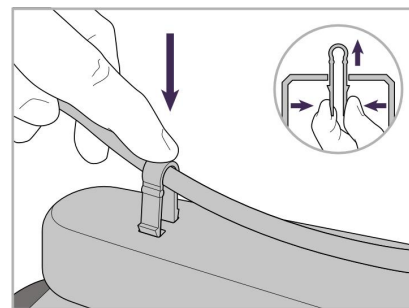

19. Secure the cable to the bottom of the wheel stand with the clip.

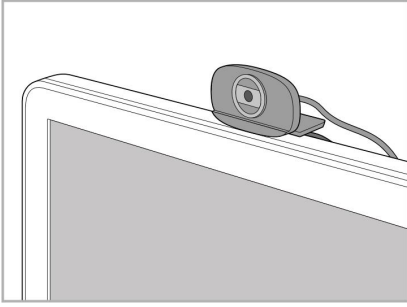

20. Position the webcam on the touch screen for remote training or support sessions.

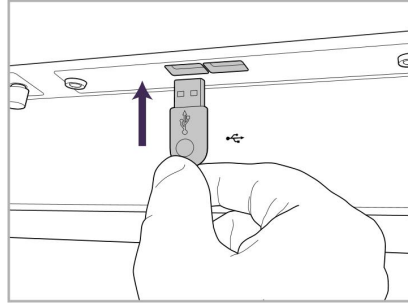

21. Connect the webcam to the USB port at the bottom of the touch screen.

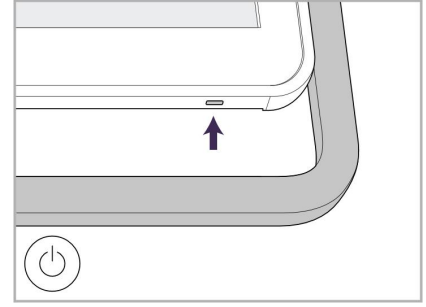

22. Plug the power cable into the AC power outlet and then press the Power button to switch on the scanner.



## 2.2 Assembling the iTero Element 5D laptop-configuration scanner

Follow the instructions below to assemble the iTero Element 5D laptop-configuration scanner.

- A Hub and hub power cable
- B Cradle
- C Wand and wand cable
- D USB cable to connect laptop and hub

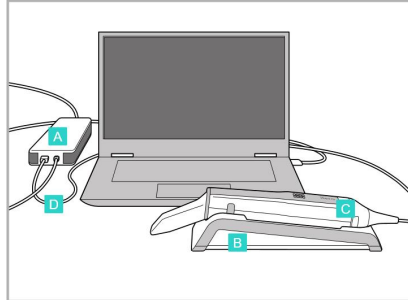

1. Place the wand in the cradle.

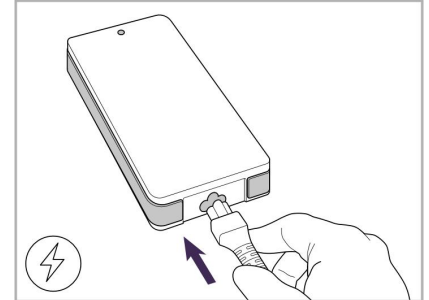

2. Connect the hub power cable to the hub.

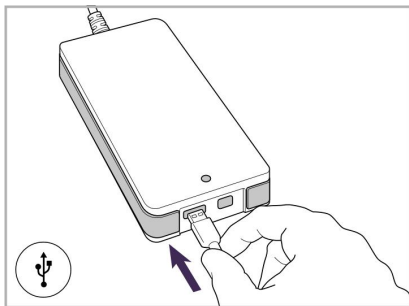

3. Connect the USB cable to the hub.

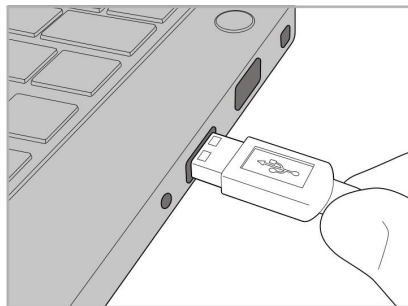

4. Connect the USB cable to the laptop.

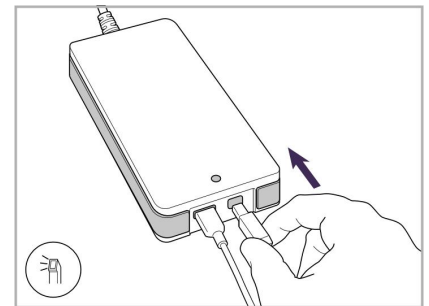

5. Connect the wand cable to the hub.

6. Plug the hub power cable into the AC power outlet.

### Notes:

- The hub must be connected to an AC wall outlet at all times.
- The laptop should be connected to an AC wall outlet during intraoral scanning.

### 2.2.1 Installing the iTero Element 5D software – laptop configuration

New iTero Element 5D wheel-stand configuration systems come with the software installed, but the user must download and install the software on iTero Element 5D laptop-configuration systems.

### Notes:

- Before installing the iTero software, please install all available Windows updates. New Windows computers should apply the updates automatically.
- Ensure that one of the following compatible antivirus programs has been installed: Norton, McAfee, or ESET.

For proper software installation and configuration of the iTero Element 5D laptop-configuration system, please ensure the following:

- The wand is secure in the cradle and connected to the hub
- The hub is connected to the laptop
- The laptop is plugged into the AC wall socket during the entire software installation

**To install the iTero software:**

1. Install all available Windows updates.
  - a. To check for Windows Updates, open the *Windows Settings* window (Winkey + I) and click **Update & Security**.
  - b. Click **Windows Update**.
  - c. Click **Check for updates** to see whether there are new updates available.
2. In the registered email Inbox, look for the email “Your iTero was shipped”, which includes the download instructions.
3. Click the link to access the software download page or browse to <http://download.itero5D.com>.
4. On the website, click the **Get Started** button. The **FirstTimeInstaller.exe** file will be downloaded.
5. Run the downloaded installation file and follow the instructions on the screen to complete the iTero software installation.

The *Welcome* screen is displayed. Proceed as described in [Registering the scanner – Make It Mine process](#).

## 2.3 Assembling the iTero Element 5D Plus and 5D Plus Lite scanner – cart configuration

The scanner packaging is designed in a way that provides a simple and easy assembly process.

Follow the instructions below to assemble the scanner.

Contact iTero Support for additional help.

- A** 2x Allen keys  
(in the white foam on top of the post)
- B** Post
- C** Wheel base
- D** Main handle  
(in the accessory box)
- E** New-sleeve basket  
(in the accessory box)
- F** Upper handle  
(in the accessory box)
- G** Full HD touch-screen computing unit
- H** Cradle
- I** Wand
- J** Power cable
- K** Webcam
- L** Power switch

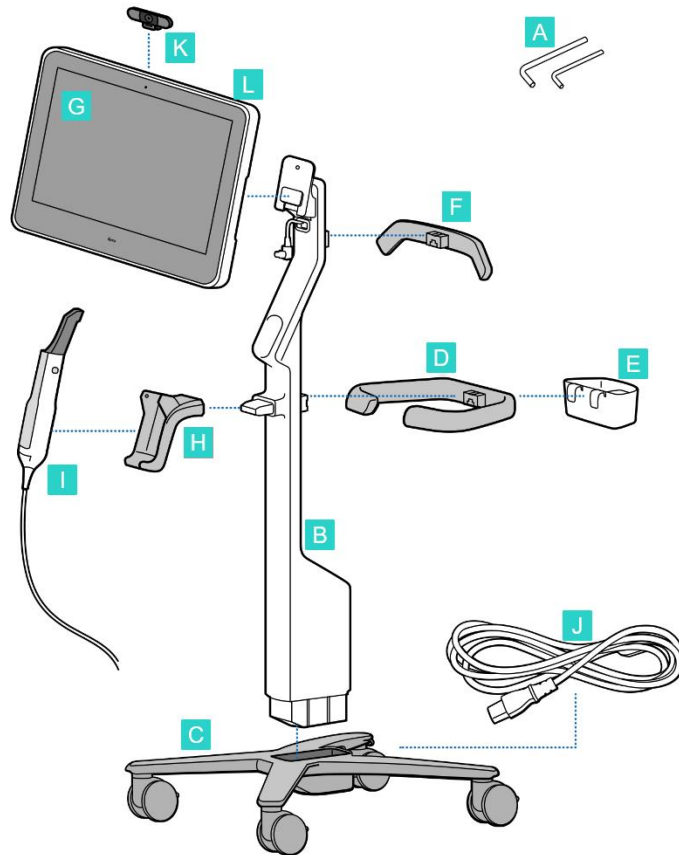

**Note:** If any damage to the system or accessories is found, do not assemble or use the scanner and contact iTero Support.

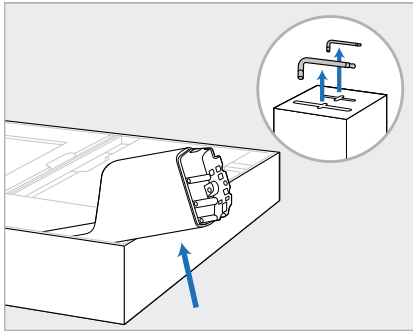

1. Remove all Styrofoam coverings from the box.  
**Note:** The two Allen keys (A) are on top of the Styrofoam covering the post (B).
2. Lift the post (B), pull it out slightly, and rest it on the side of the box.

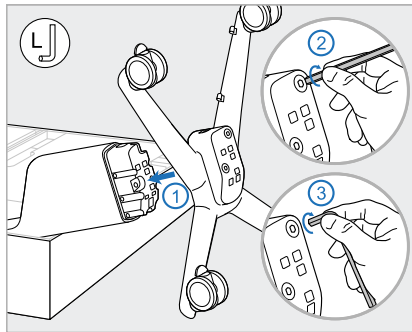

3. Attach the wheel base (C) to the end of the post (B) and tighten using first the longer side of the large Allen key and then the shorter side.

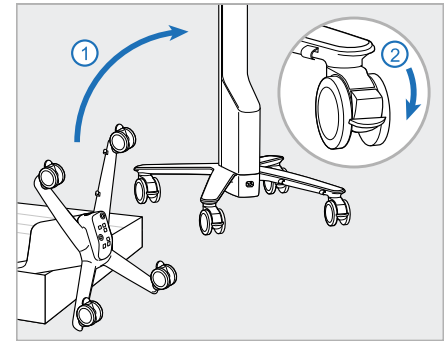

4. Move the wheel stand to an upright position and lock at least two wheels.

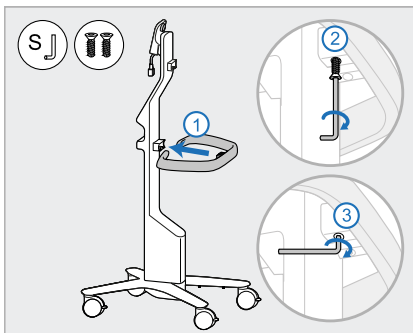

5. Remove the main handle (D) and the two screws from the accessory box. Attach the main handle and tighten using first the longer side of the small Allen key and then the shorter side.

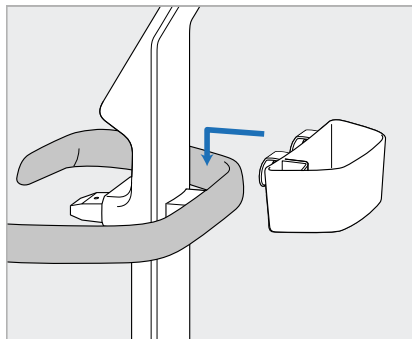

6. Remove the sleeve basket (E) from the accessory box and place it on the back of the main handle (D).

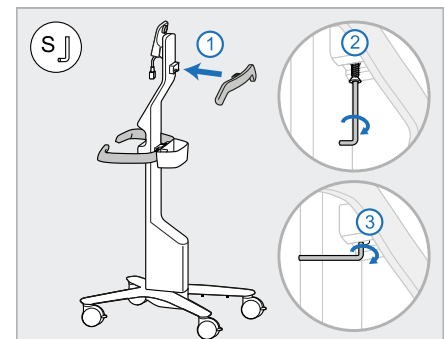

7. Remove the upper handle (F) from the accessory box and remove the pull tab to access the screw.
8. Attach the upper handle (F) to the post (B) and tighten using first the longer side of the small Allen key and then the shorter side.

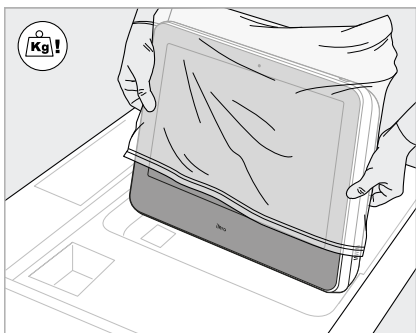

9. Carefully remove the computing unit (G) from its protective wrapping.  
**Note:** The computing unit is heavy and must be lifted carefully.

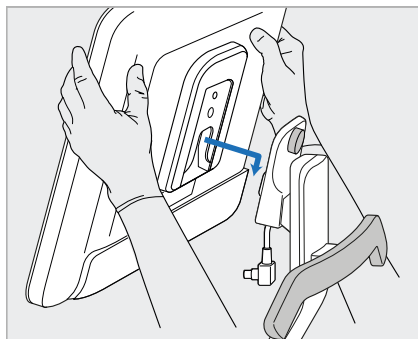

10. Standing behind the wheel stand, mount the computing unit (G) on the metal hinge and push down.  
**Note:** Make sure the computing unit does not press on the screen cable. If it does, move the cable to the side.

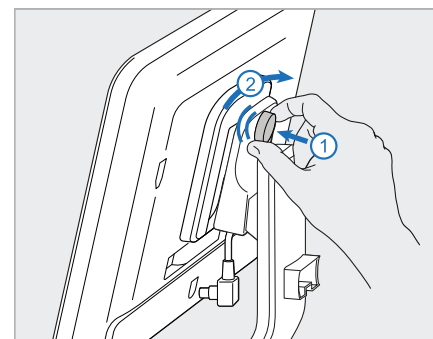

11. Attach the computing unit (G) by pushing in and tightening the screw.

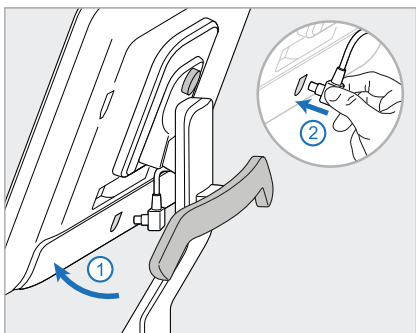

12. If the cable connector is covered, remove the cover.  
 Tilt the screen upwards and connect the screen cable.

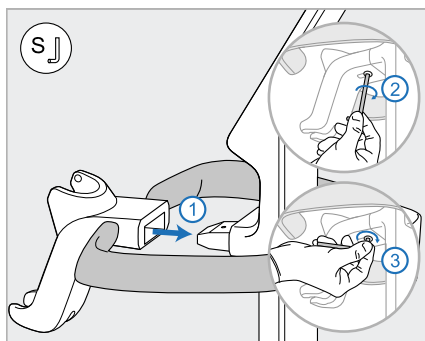

13. Attach the cradle (H) to the post (B) and tighten using first the longer side of the small Allen key and then the shorter side.

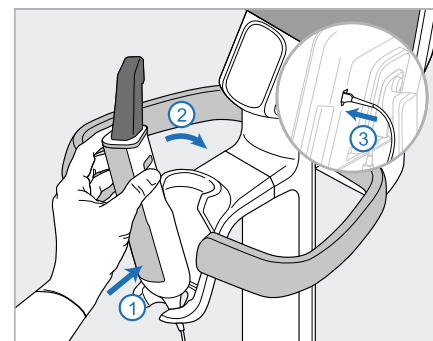

14. Insert the base of the wand (I) in the cradle (H) and then apply gentle pressure to make sure the wand is fully inserted and secure in the cradle.  
 15. Connect the wand cable to the back of the screen (G).

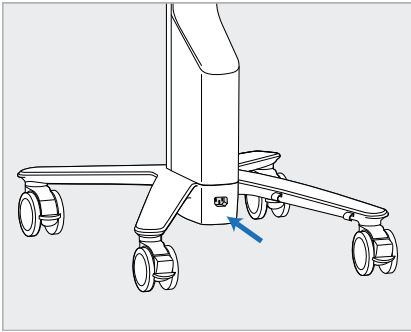

16. Connect the power cable (J) to the bottom of the wheel stand.

**Warning:** Use only the supplied power cable, which has a protective earth lead.

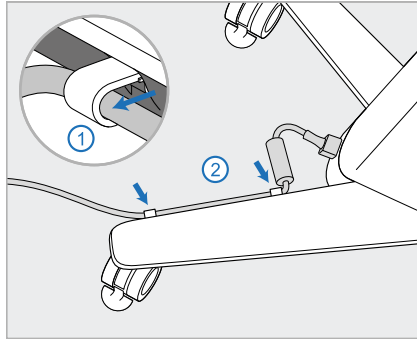

17. Secure the power cable (J) in the two cable clips, making sure it is fully inserted.

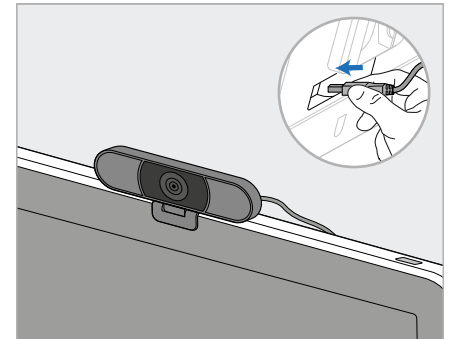

18. For remote training or support sessions, position the webcam (K) on the screen and then connect it to the USB port at the back of the screen.

**Note:** The webcam must be disconnected after each training or support session.

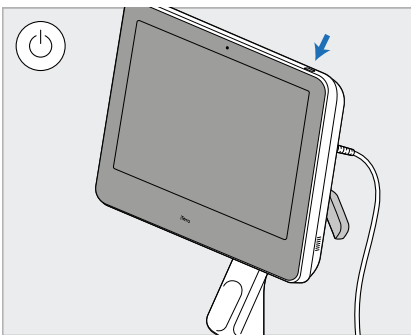

19. Plug the power cable (J) into a power outlet and then press the Power button (L) to switch on the scanner.

**Notes:**

- Always return the wand to the cradle after each use.
- The wand, cradle, and other system components should be cleaned and disinfected before each patient, as described in [Care and maintenance](#).
- Ensure that the scanner is positioned in a location where it can easily be disconnected from the power outlet.

To remove the wand from the cradle, first pull the upper part of the wand towards you and then gently remove it from the cradle.

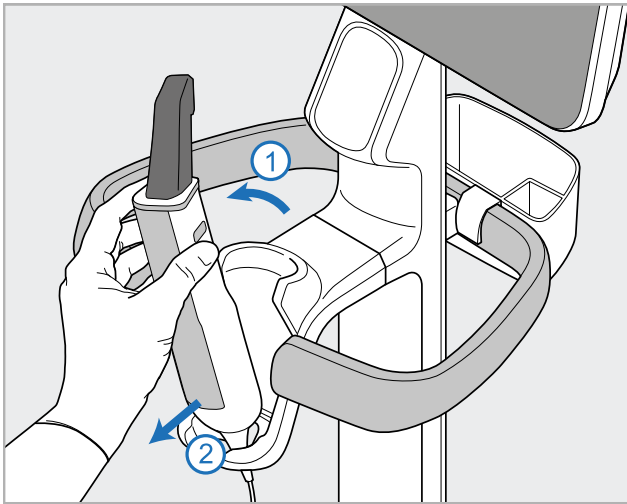

Figure 14: Removing the wand from the cradle

When moving the scanner, carefully wrap the power cable around the upper handle and then use the upper handle to push the scanner.

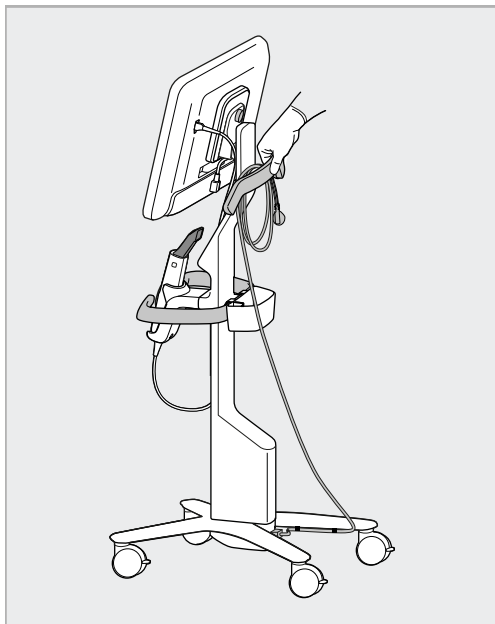

Figure 15: Moving the scanner

If the scanner needs to be lifted, use the upper handle and the post.

**Do not** use the main handle to lift the scanner.

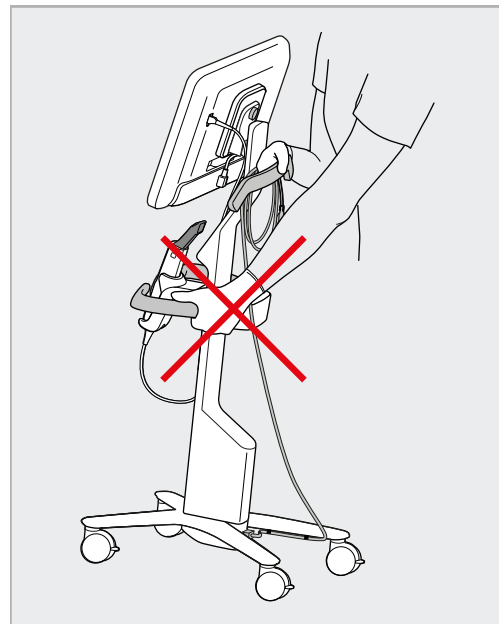

Figure 16: Do not lift the scanner using the main handle

## 2.4 Assembling the iTerO Element 5D Plus and 5D Plus Lite scanner – mobile configuration

The scanner packaging is designed in a way that provides a simple and easy assembly process.

Follow the instructions below to assemble the scanner.

Contact iTero Support for additional help.

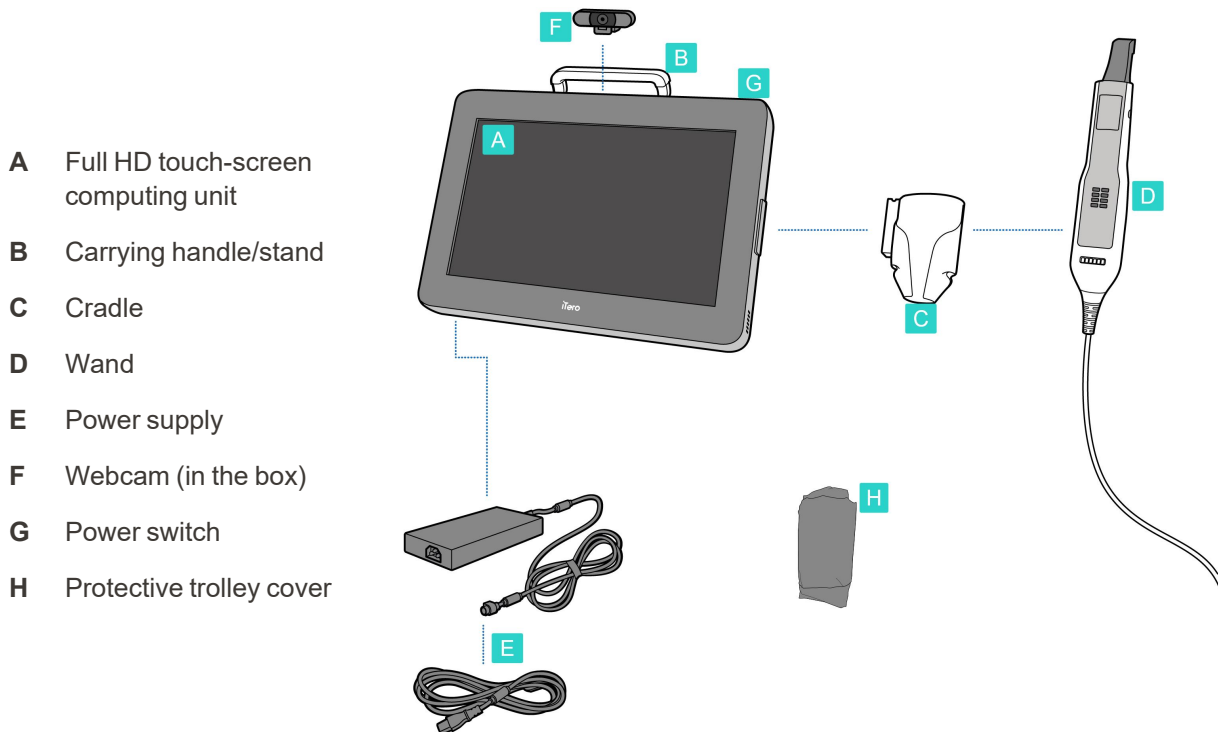

**Note:** If any damage to the system or accessories is found, do not assemble or use the scanner and contact iTero support.

This section describes how to:

- Assemble the scanner, described in [Initial assembly](#)
- Move the scanner within the clinic, described in [Moving the scanner within the clinic](#)
- Pack the scanner in the trolley before transporting it, described in [Using the trolley for transportation](#)
- Protect the trolley with the optional protective cover, described in [Optional protective trolley cover](#)
- Mount the scanner on a VESA mount, described in [VESA mounting](#)



### 2.4.1 Initial assembly

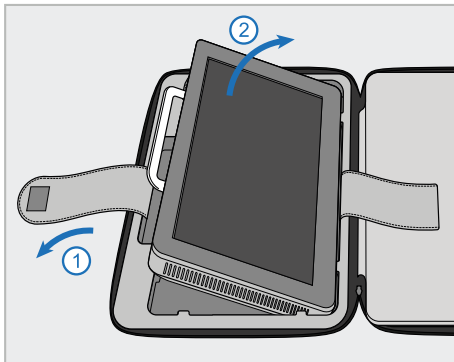

1. Undo the strap holding the computing unit (A), and then remove it using the handle (B).

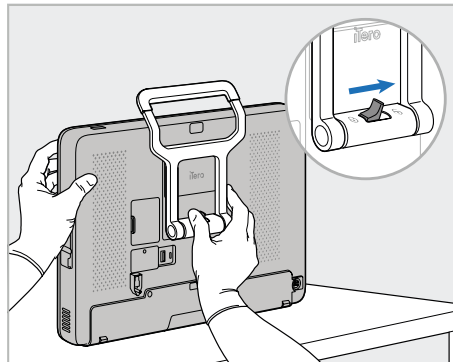

2. Rest the computing unit (A) on a smooth, flat surface and hold it with one hand.

While holding the computing unit, slide the locking latch to the right until you feel a click, to unlock the handle (B).

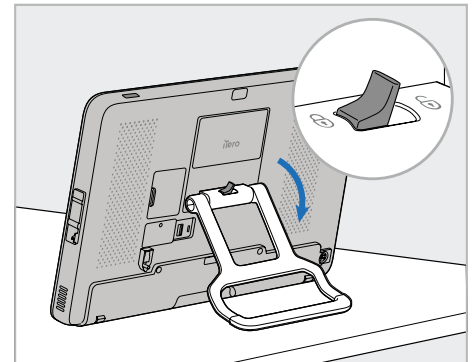

3. Move the handle (B) down to the standing position. Ensure that the handle is securely locked in place by trying to pull it back up.

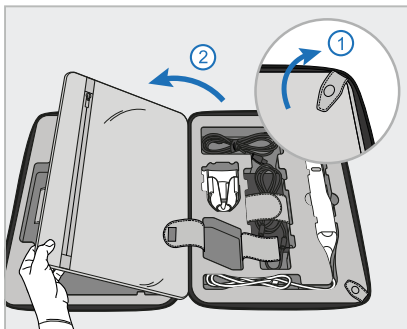

4. Undo the snaps and open the flap to remove the rest of the scanner components.

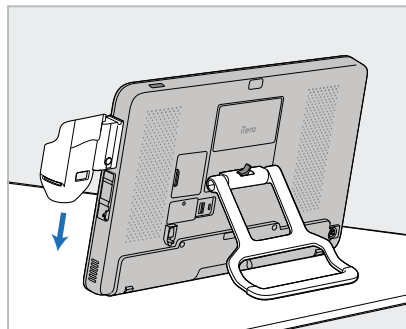

5. Slide down the cradle (C) on the slider on the side of the computing unit (A) until it clicks into place. Make sure the cradle is secure and cannot be removed.

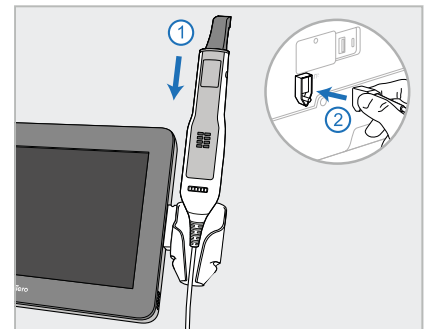

6. Place the wand (D) in the cradle (C) and connect the wand cable to the port marked **A** at the back of the computing unit (A).

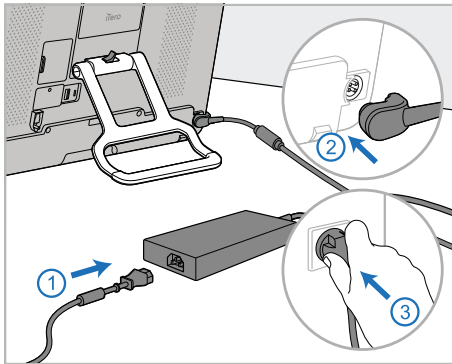

7. Connect the power cable to the power supply (E). Afterwards, connect one side of the cable to the back of the computing unit (A) and the other side to a power outlet.

**Warning:** Use only the supplied power cable, which has a protective earth lead.

**Note:** Place the cable in a safe manner so that no one is likely to accidentally trip over it.

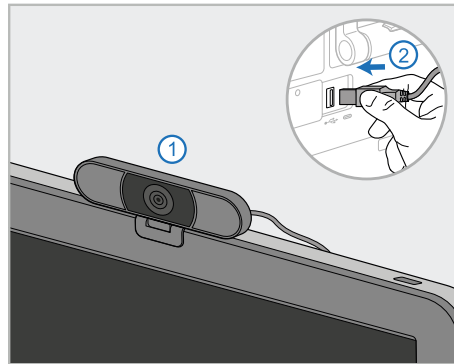

8. For remote training or support sessions, position the webcam (F) on the computing unit (A) and then connect it to the USB port at the back of the computing unit.

**Note:** The webcam is packed in the scanner box.

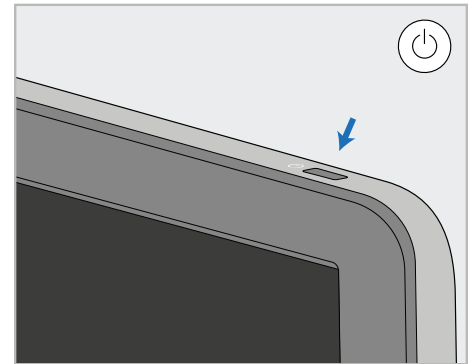

9. Press the power button (G) to turn on the scanner.

#### Notes:

- The webcam must be disconnected after each training or support session.
- Always return the wand to the cradle after each use.
- The wand, cradle, and other system components should be cleaned and disinfected before each patient, as described in [Care and maintenance](#).
- Ensure that the scanner is positioned in a location where it can easily be disconnected from the power outlet.

### 2.4.2 Moving the scanner within the clinic

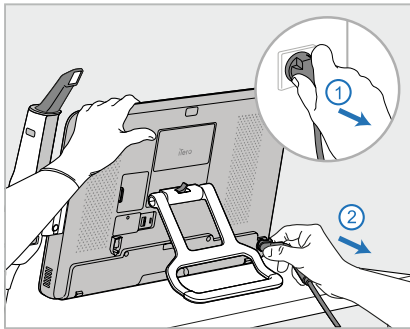

1. Ensure that the wand (D) is firmly positioned in the cradle (C).
2. Disconnect the power cable (E) from the mains and then from the back of the computing unit (A).

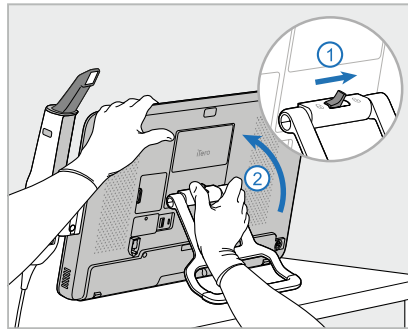

3. While holding the computing unit (A) with one hand, slide the locking latch to the right to unlock the handle (B) and then move the handle to the carrying position.

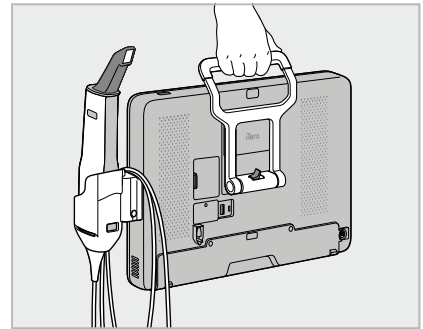

4. Loosely wrap the wand cable around the cradle (C) for easy and safe portability.

### 2.4.3 Using the trolley for transportation

Before transporting the scanner, it must be packed into the supplied trolley.

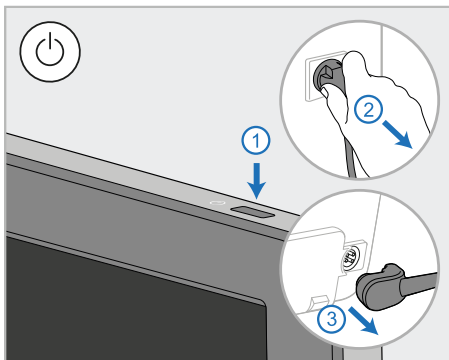

1. Turn off the scanner and disconnect the power cable (E) from the mains and then from the back of the computing unit (A).

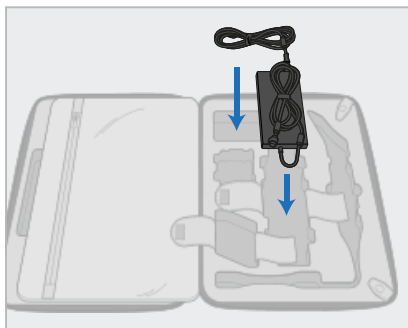

2. For easier packing, start by placing the power pack (E) in its designated compartment in the trolley. Wrap the thinner part of the cable and place it on top of the power supply, and then wrap the thicker part of the cable and place it in its compartment in the trolley.

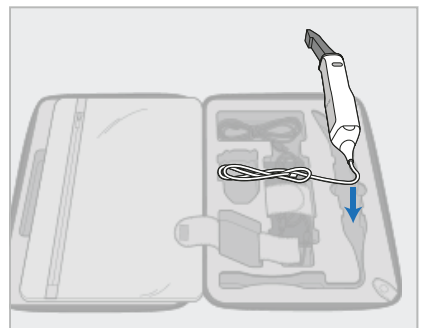

3. Disconnect the wand (D) and place it in its compartment in the trolley.

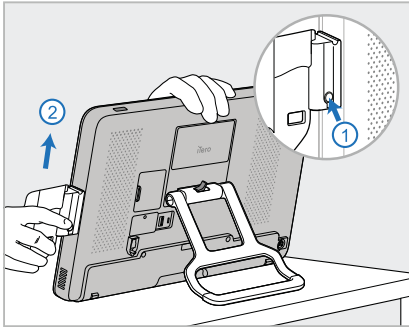

4. While holding the computing unit (A) with one hand, remove the cradle (C) by pressing the release button and pulling up the cradle.

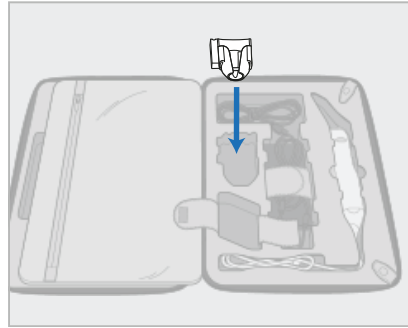

5. Place the cradle (C) in the trolley.

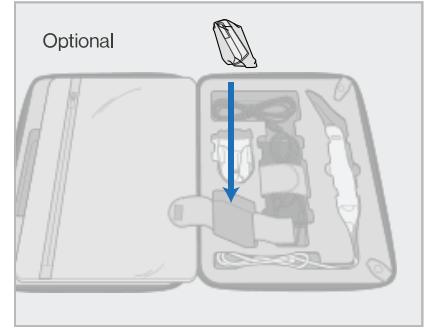

6. Optional: Place new sleeves in the compartment next to the cradle (C), instead of the protective trolley cover (H).

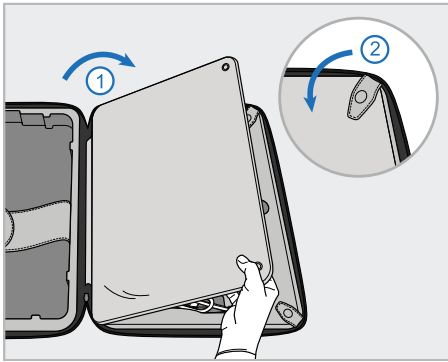

7. Move the flap to cover the scanner components and then secure the flap with the snaps.

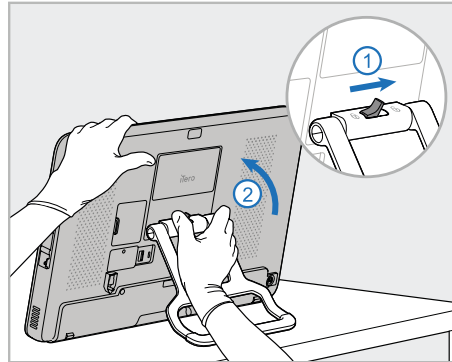

8. Slide the locking latch to the right to unlock the stand (B) and then move it to the carrying position.

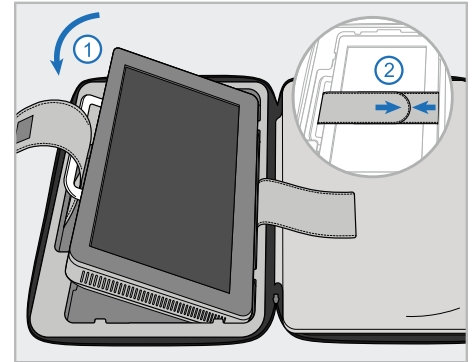

9. Place the computing unit (A) in its compartment in the trolley. Thread the outer strap through the handle (B) and close the straps to ensure that it is held securely in place.

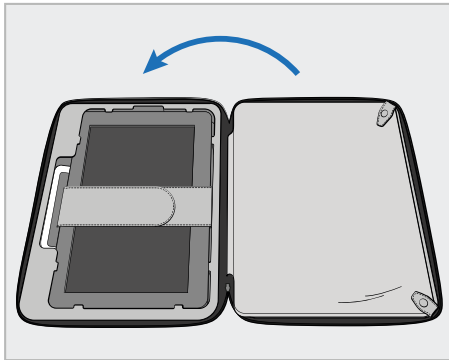

10. Close the trolley by lifting the side with the fastened flap and then zipping it closed.

You are now ready to travel with your scanner.  
If required, you can use the optional protective trolley cover (H), described in [Optional protective trolley cover](#).

**Notes:**

- The trolley must be handled with care.
- Avoid leaving the trolley in the sun in order to prevent the scanner from reaching extreme temperatures.
- Make sure the trolley is kept dry to protect the system components from humidity.
- If the scanner has just been brought into the office from a hot, cold, or humid environment, it should be set aside until it has adjusted to room temperature, to avoid internal condensation.
- Do not check the trolley as baggage when traveling by air, to prevent damage to the scanner that may be caused by uncontrolled transportation conditions.

#### 2.4.4 Optional protective trolley cover

The trolley is supplied with an optional protective cover that helps protect it against wear and tear and adverse weather conditions.

**Note:** The protective cover provides a certain level of protection against rain, but is not waterproof.

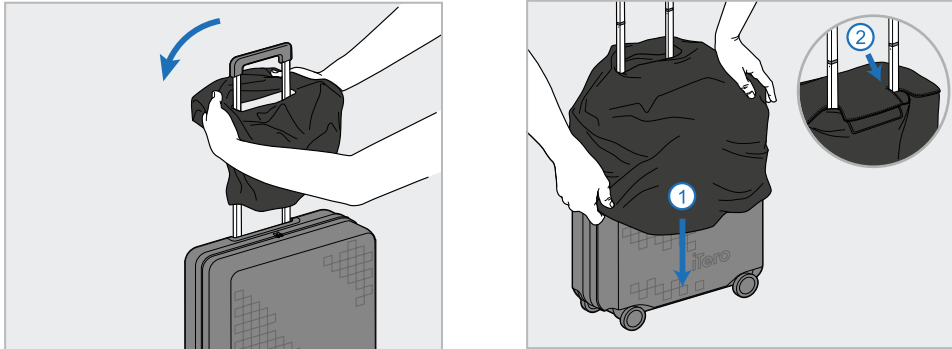

1. Open the VELCRO® flap and slip the protective cover (H) over the trolley handle.
2. Pull down to cover the trolley and then close the VELCRO® flap.

#### 2.4.5 VESA mounting

The scanner provides a standard 100mm VESA mounting interface that can be used for mounting it using 3rd party VESA-based mounting solutions.

**Notes:**

- **Ensure that the selected VESA mounting solution supports the following scanner specifications:**
  - VESA 100mm
  - Minimum weight: 6kg (including the computing unit, wand, and cradle).  
Recommended weight: 9kg.
- If the scanner has already been assembled, you must remove the power cable and the cradle, as described in [Using the trolley for transportation](#).
- We recommend that connecting the computing unit to the VESA mount, step 3 below, be performed by two people.

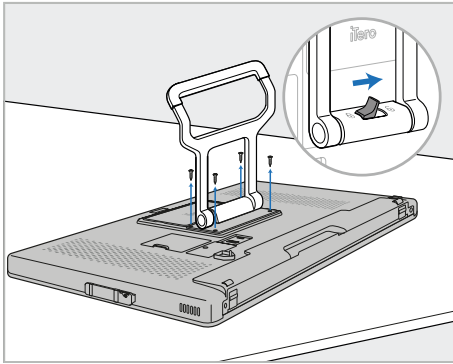

1. Lay the computing unit (A) face down on a smooth, flat surface. Remove the 4 screws with a Phillips screwdriver, while holding and moving the handle (B), as required.

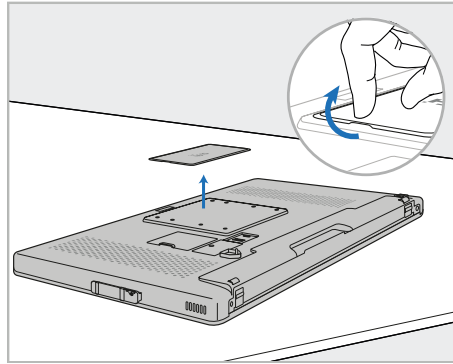

2. Remove the iTero back cover plate to expose the VESA screw holes. (It is recommended to store the cover plate and screws in the trolley.)

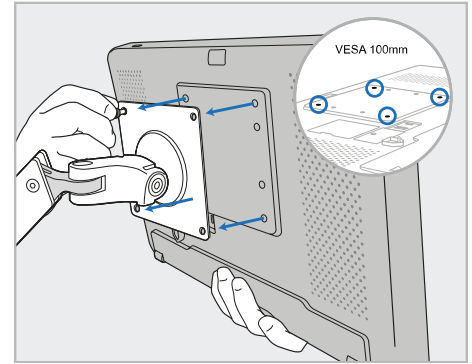

3. Connect the computing unit (A) to the external VESA mount (VESA 100) using the screws supplied with the mounting solution. Optional: You can purchase a 3m power cable from Align, if required.

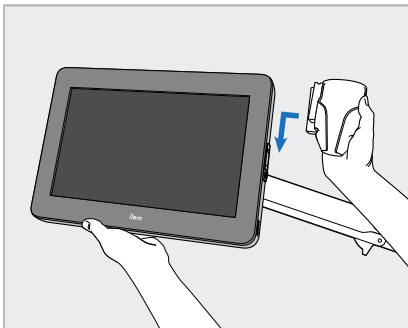

4. While supporting the computing unit (A) with one hand, slide the cradle (C) on the slider on the side of the computing unit until it clicks into place.

Make sure the cradle is secure and cannot be pulled off.

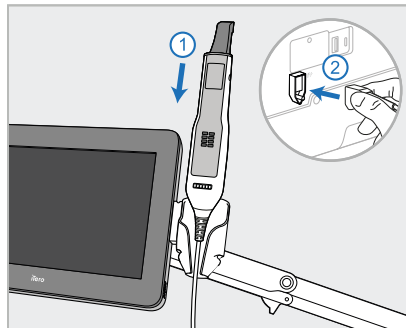

5. Place the wand (D) in the cradle (C) and connect the wand cable to the port marked **A** at the back of the computing unit (A).

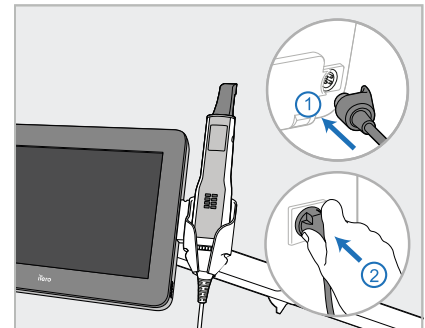

6. Connect the power cable (E) to the back of the computing unit (A) and then to the mains.

**Notes:**

- Ensure that the power pack rests on the floor or on a table and does not dangle in the air.

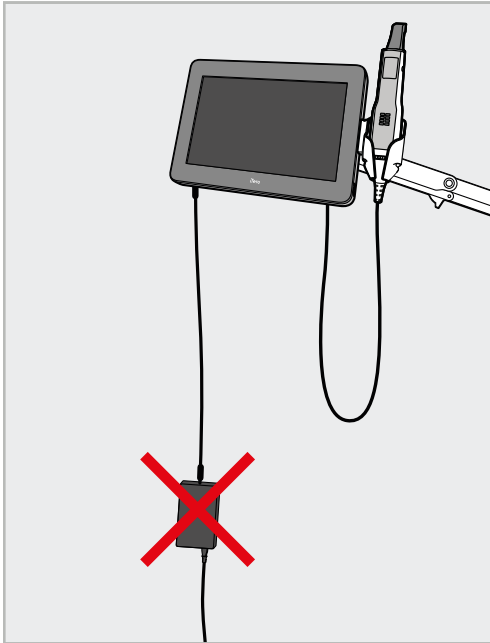

Figure 17: Do not allow the power pack to dangle in the air

- Never tilt the screen more than 45 degrees to make sure that the wand does not slip out of the cradle.

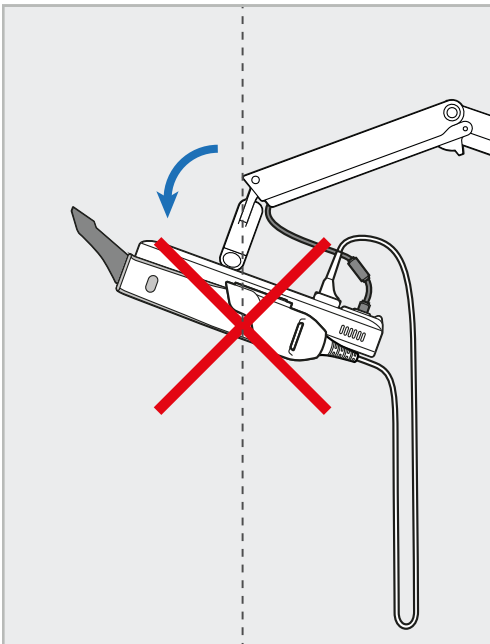

Figure 18: Never tilt the screen more than 45 degrees



## 3 Getting started

### 3.1 Logging in to the scanner for the first time

When you turn on the scanner for the first time, the *Welcome* screen is displayed:

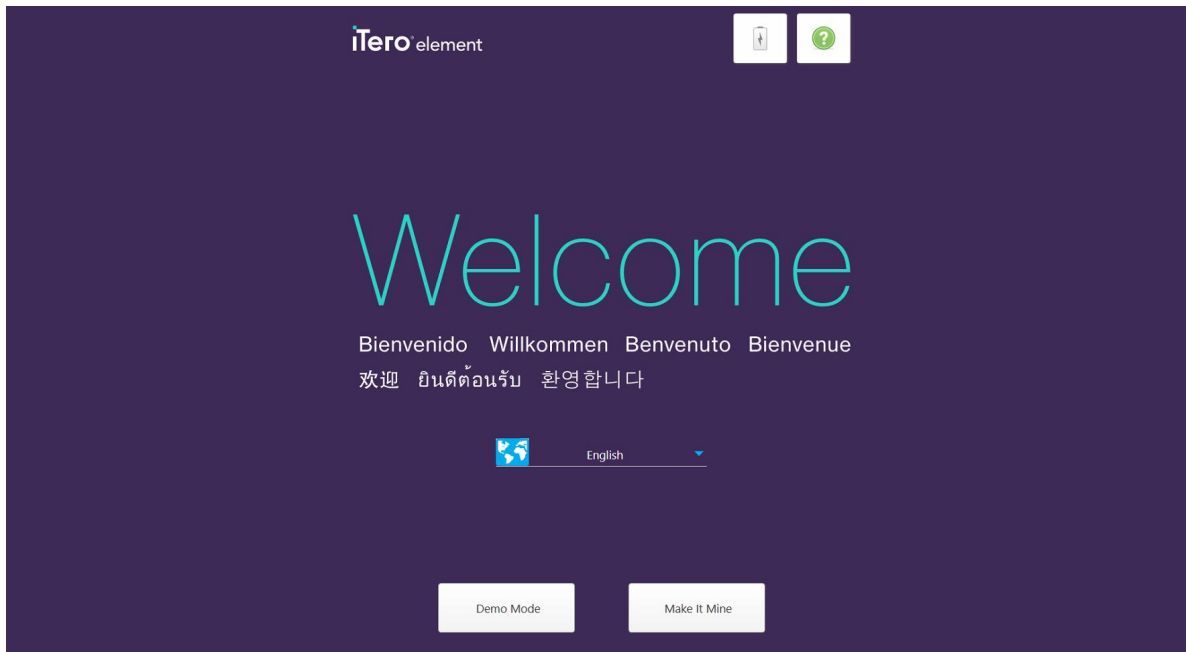

Figure 19: Welcome screen

Select the required language and the **Make It Mine** option.

### 3.2 Registering the scanner – Make It Mine process

When registering the scanner, you need the following details to complete the registration process:

- User Name
- User Password
- Company ID

You will receive an email from an iTero representative with login credentials and detailed information on how to proceed with the **Make It Mine** process.

#### To register the scanner:

1. In the *Welcome* page, select the required language.

2. Tap **Make It Mine**.

The *Connect* page is displayed, showing a list of available networks.

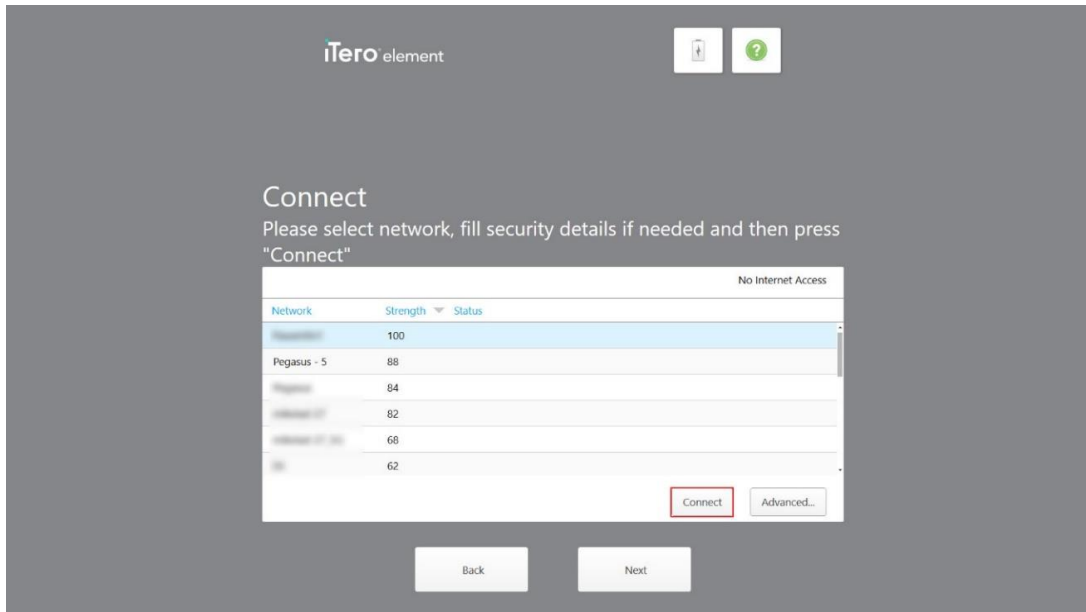

Figure 20: Connect page listing the available networks

3. Select the clinic network from the list and then tap **Connect**.

You are prompted to enter the network security key.

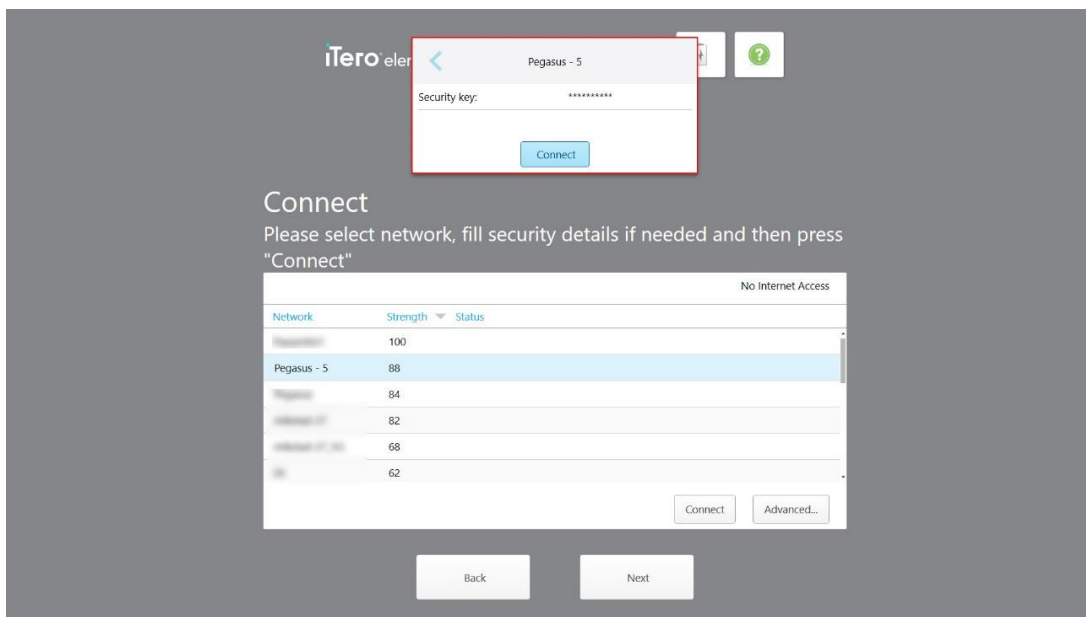

Figure 21: Entering the security key

4. Enter the security key and then tap **Connect**.

The scanner is now connected to the Internet and online.

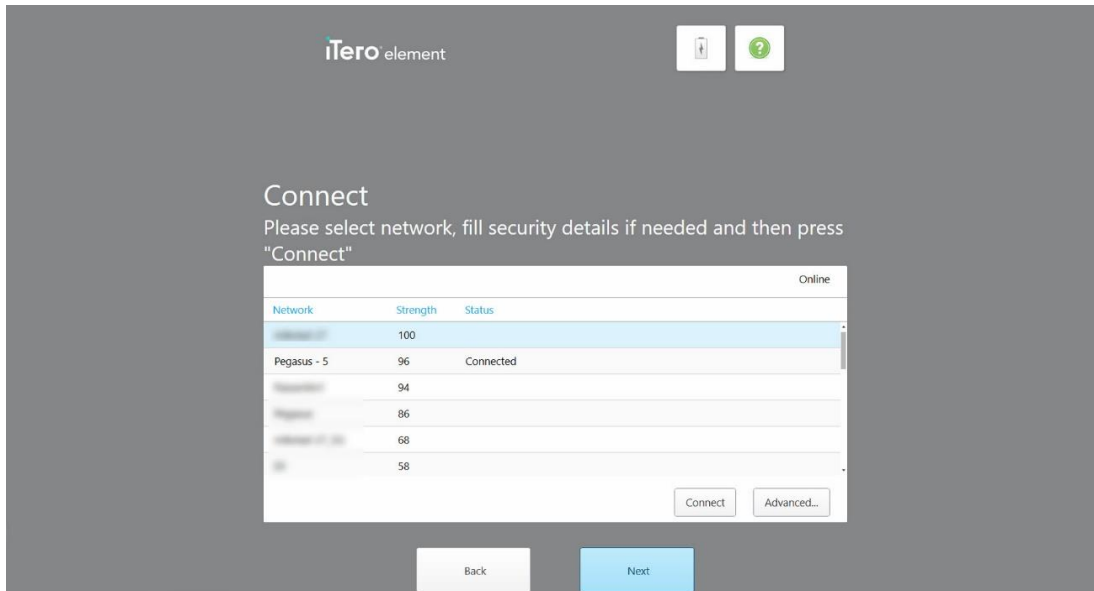

Figure 22: Scanner is connected to the Internet and online

5. Tap **Next**.

The communication with Align is verified.

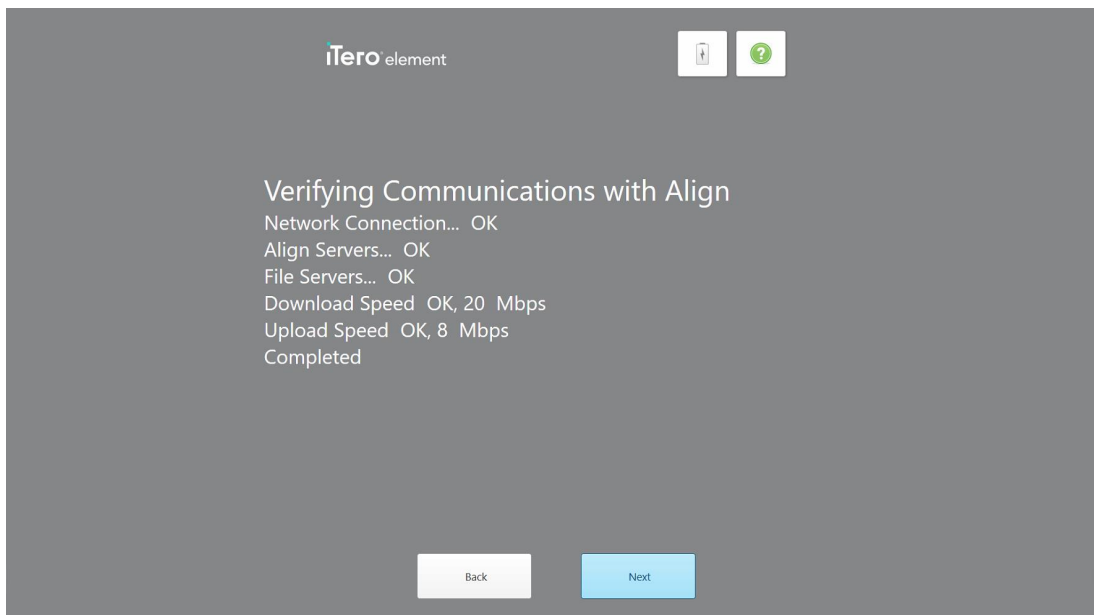

Figure 23: Verifying the communication with Align

- When the verification is complete, tap **Next**.

The *Time Zone* page is displayed.

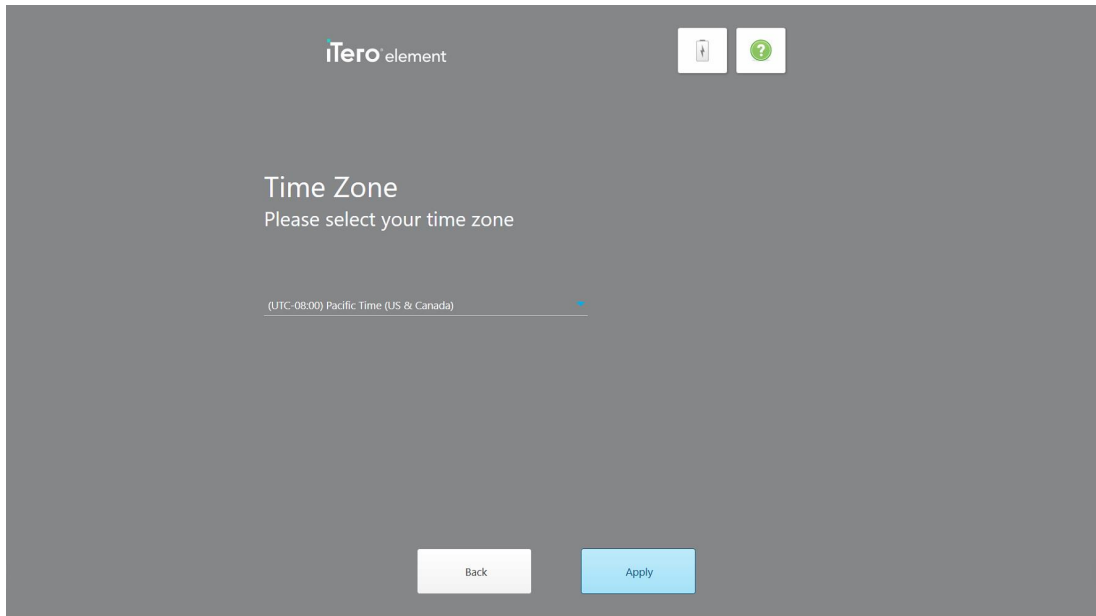

Figure 24: Selecting the time zone

- Tap **Next** if the default time zone is correct or select the time zone from the drop-down list and then tap **Apply**.

The *Register System* page is displayed.

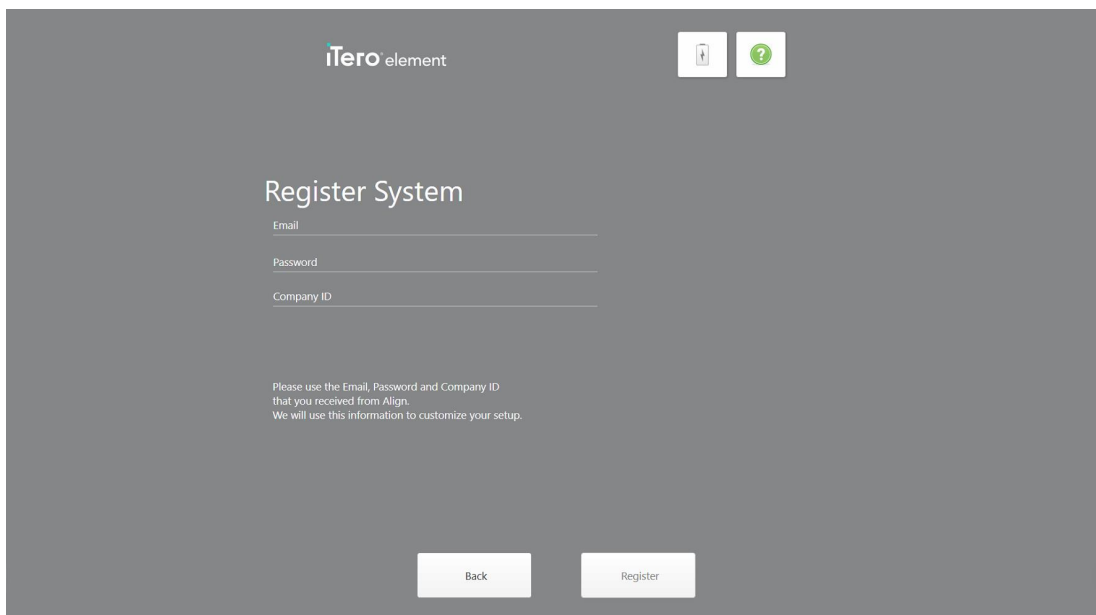

Figure 25: Registering the system to customize the setup

- Enter your email, password, and company ID in the fields provided. Tap **Register** and then tap **Next** after the system has been registered.

The *Scanner Configuration* page is displayed, showing your iTero subscription package.

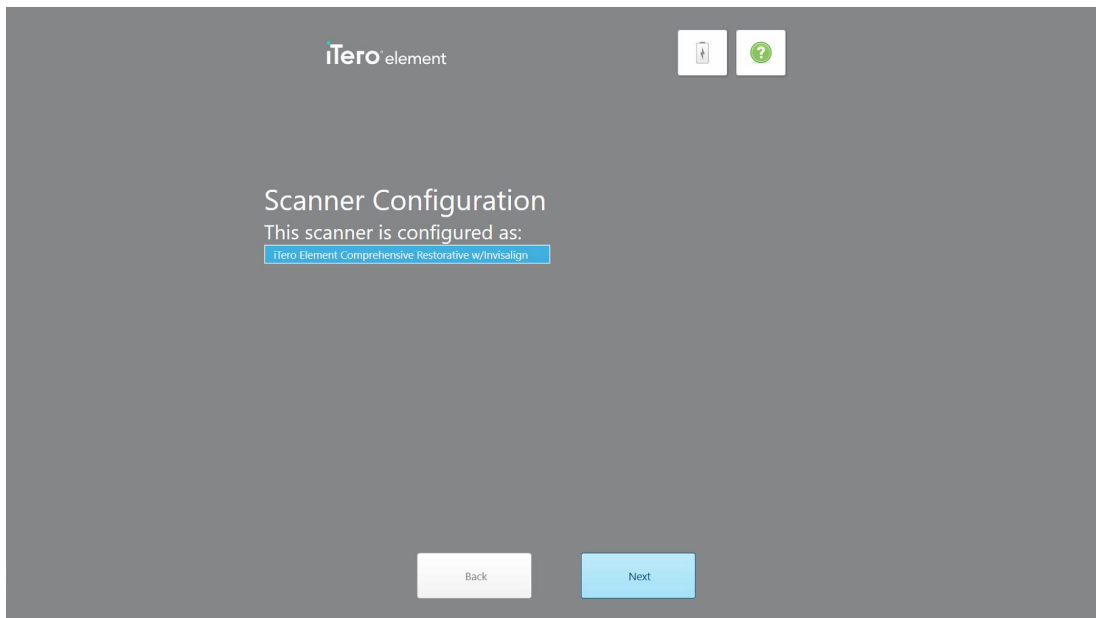

Figure 26: Example of an iTero subscription package

9. Tap **Next**.

The *License Agreement* page is displayed.

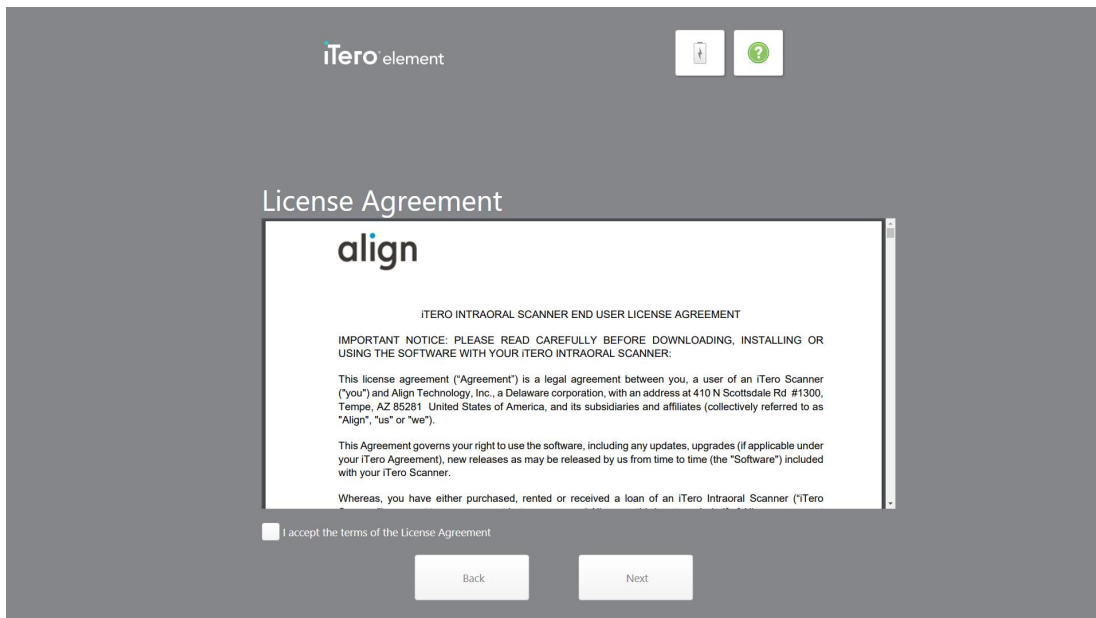

Figure 27: License agreement

10. After reviewing the license agreement, select the check box to accept the terms of the agreement and then tap **Next**.

The system checks for an upgrade and is upgraded to the latest version, if relevant.

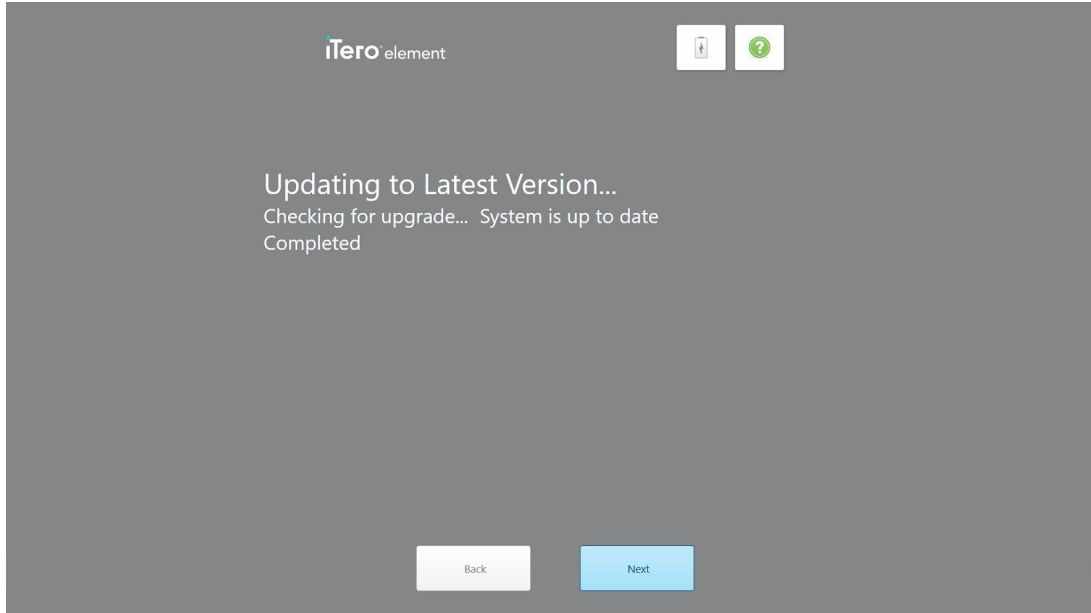

Figure 28: Checking for updates

11. Tap **Next**.

The system has been registered and is ready.

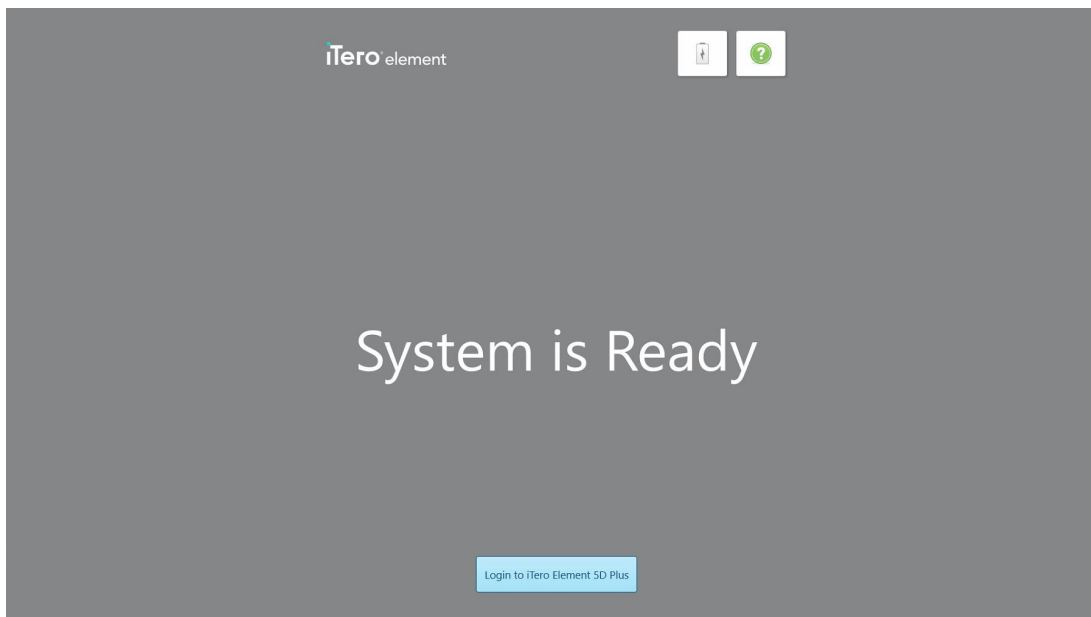

Figure 29: System is registered and ready

12. Tap **Login to iTero Element 5D Plus** to log in to the system.

The *Login* window is displayed. For more details on logging in to the system, see [Logging in to the scanner](#).

## 4 Working with the scanner

### 4.1 Logging in to the scanner

When the scanner is powered on, the *Login* window is displayed.

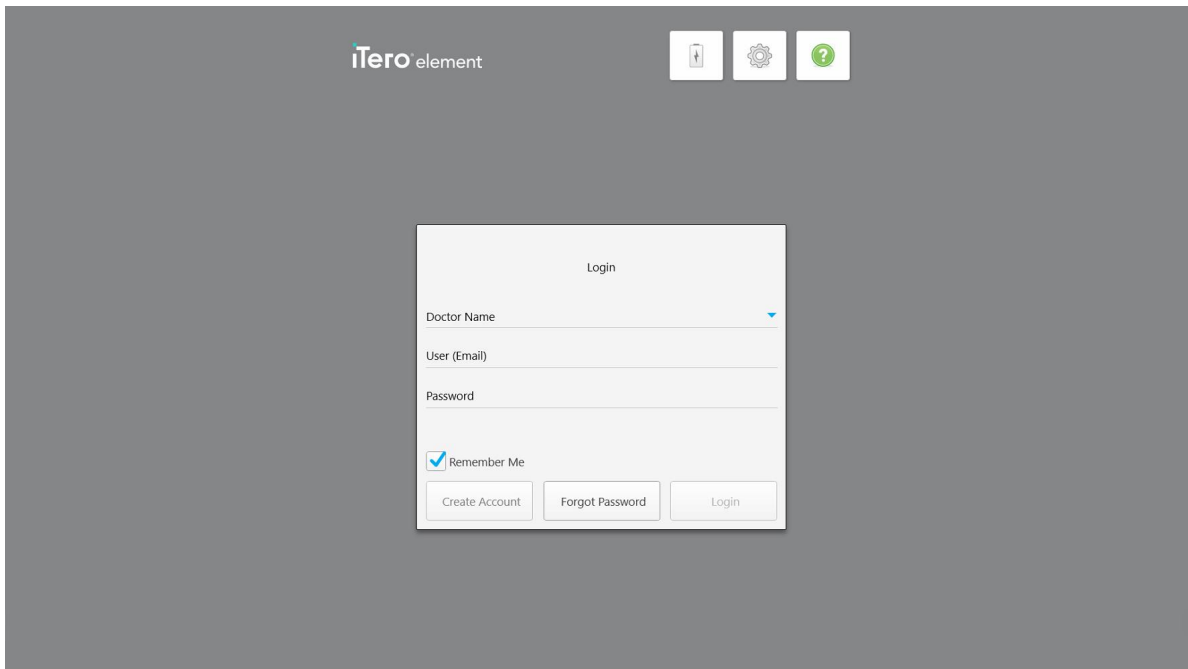

Figure 30: Login window

Make sure you have your MyAligntech account information ready when logging in to the iTerO scanner. You need your name, account email, and password. Fill in all the necessary fields and then tap the **Login** button.

#### Notes:

- **Note:** In order to ensure that all Windows security patches are up-to-date, a notification is displayed as soon as security updates are available for installation. For more information on scheduling the installation of these security updates, see [Installing Windows security updates](#).



- If you did not shut down the scanner correctly previously, a message will be displayed notifying you of this and will remain until you acknowledge the message by tapping **I UNDERSTAND**. For more information on shutting down the scanner, see [Shutting down the scanner](#).

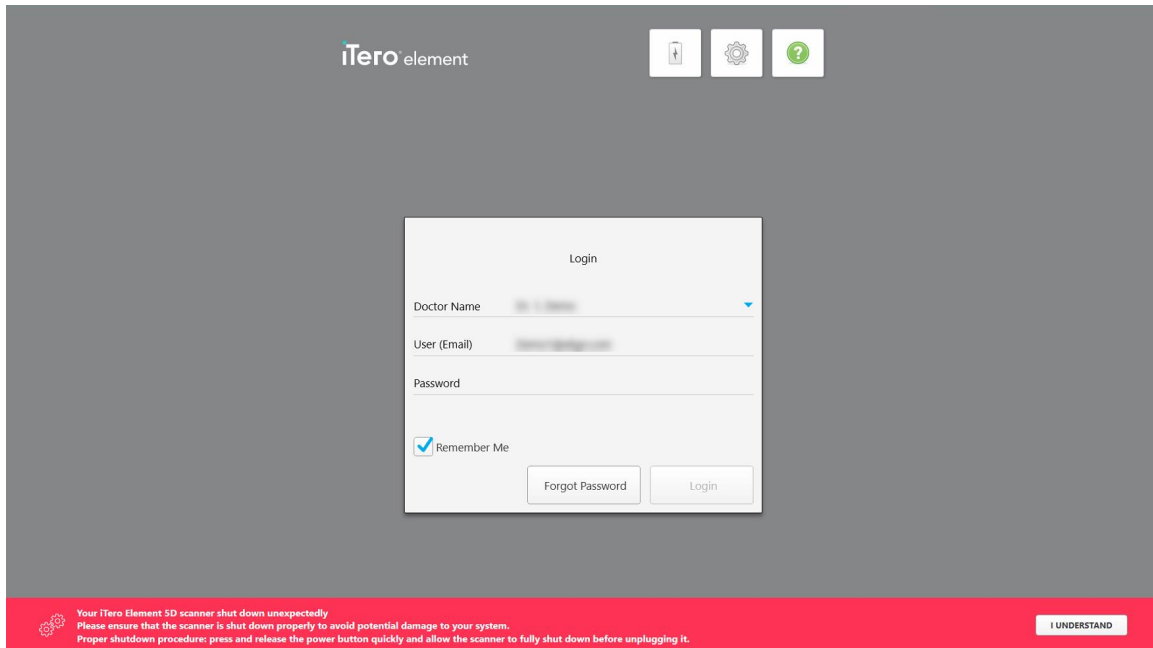
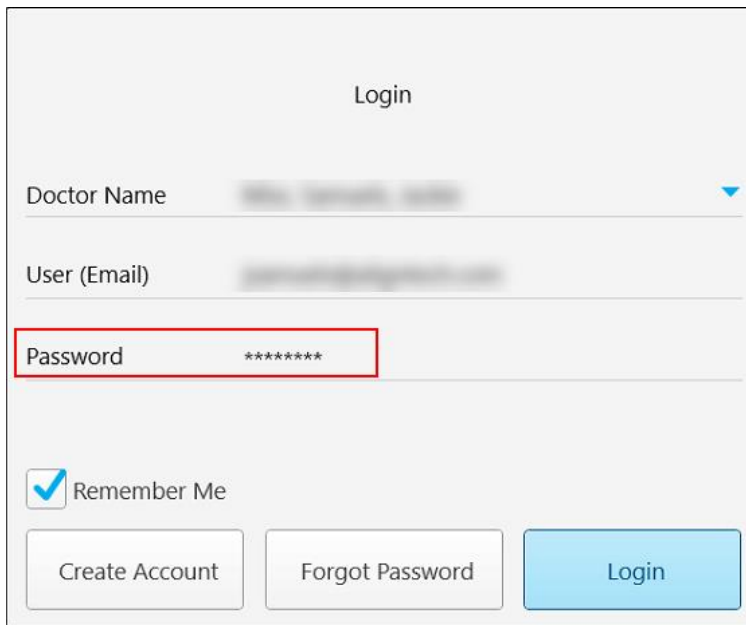

Figure 31: Unexpected shutdown notification

### To log in to the scanner:

1. Select your username from the **Doctor Name** drop-down list.
2. Enter the email address you used when registering with myaligntech.com. Your email address is displayed automatically if you selected the **Remember Me** check box in a previous login session.
3. Enter your password.

The text is masked as asterisks.



The screenshot shows a login form titled "Login". It contains three input fields: "Doctor Name" with a dropdown arrow, "User (Email)", and "Password". The "Password" field is highlighted with a red border and contains seven asterisks. Below the fields is a "Remember Me" checkbox which is checked. At the bottom are three buttons: "Create Account", "Forgot Password", and "Login".

Figure 32: Password is masked

If you have forgotten your password, you can reset it, as described in [Resetting your password](#).

4. Select the **Remember Me** check box for the system to remember your email address in future sessions. You will still need to enter your password in order to access the scanner.
5. Tap **Login**.

The iTero home screen is displayed.

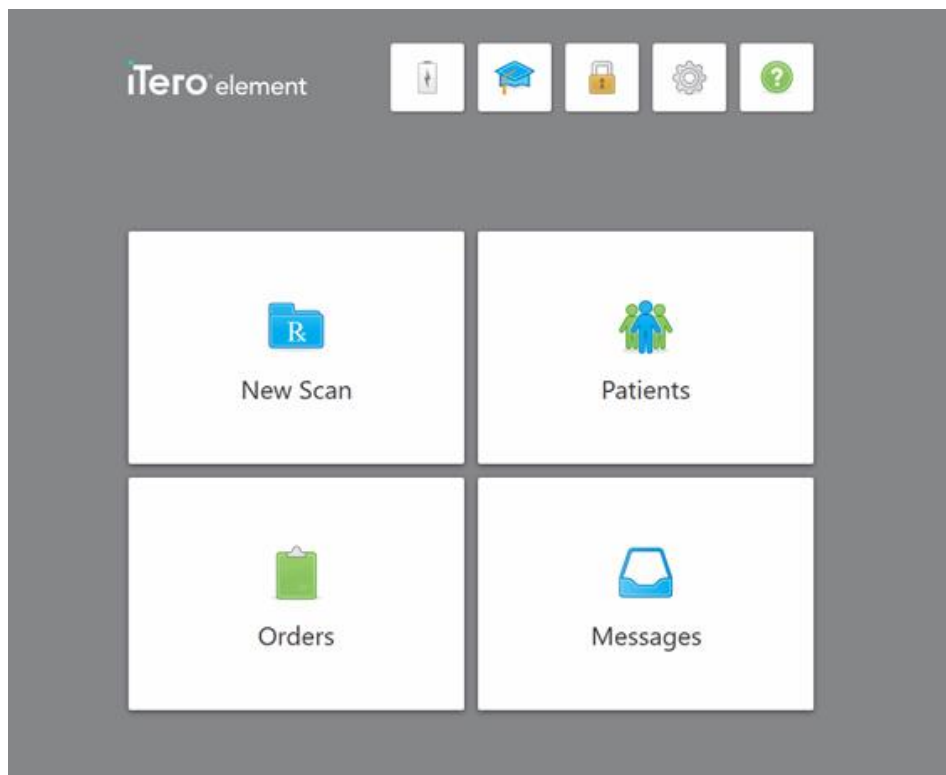

Figure 33: iTero home screen

### 4.1.1 Resetting your password

You can reset your password, if required.

**To reset your password:**

1. In the *Login* window, tap **Forgot Password**.

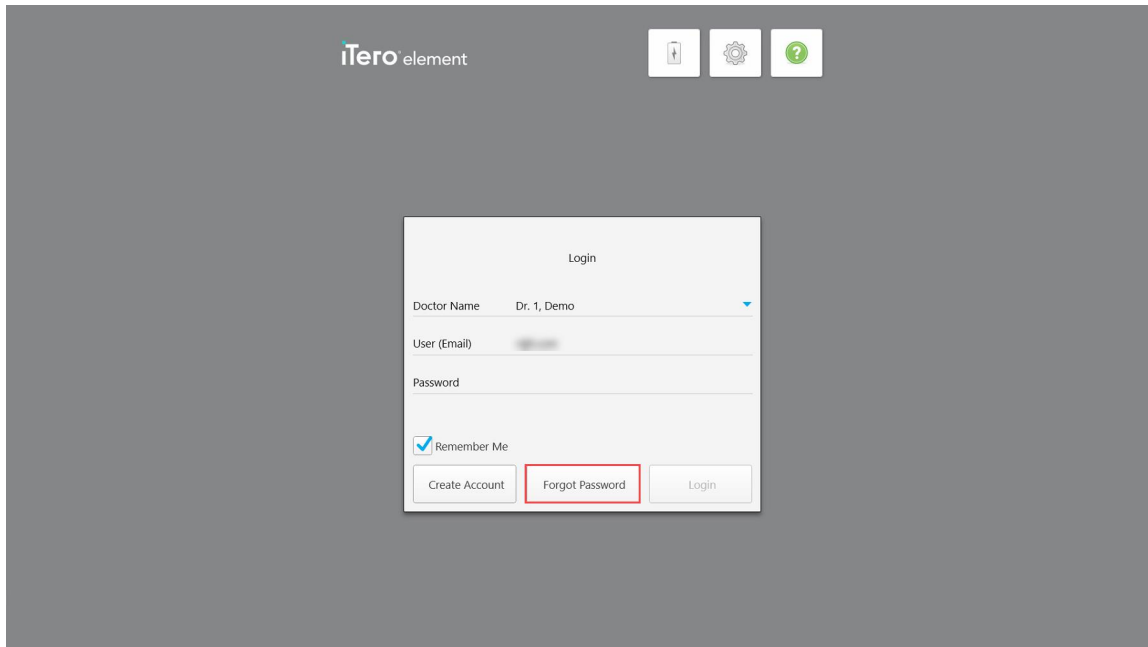

**Figure 34: Forgot Password button**

A window is displayed, describing what you should do next.

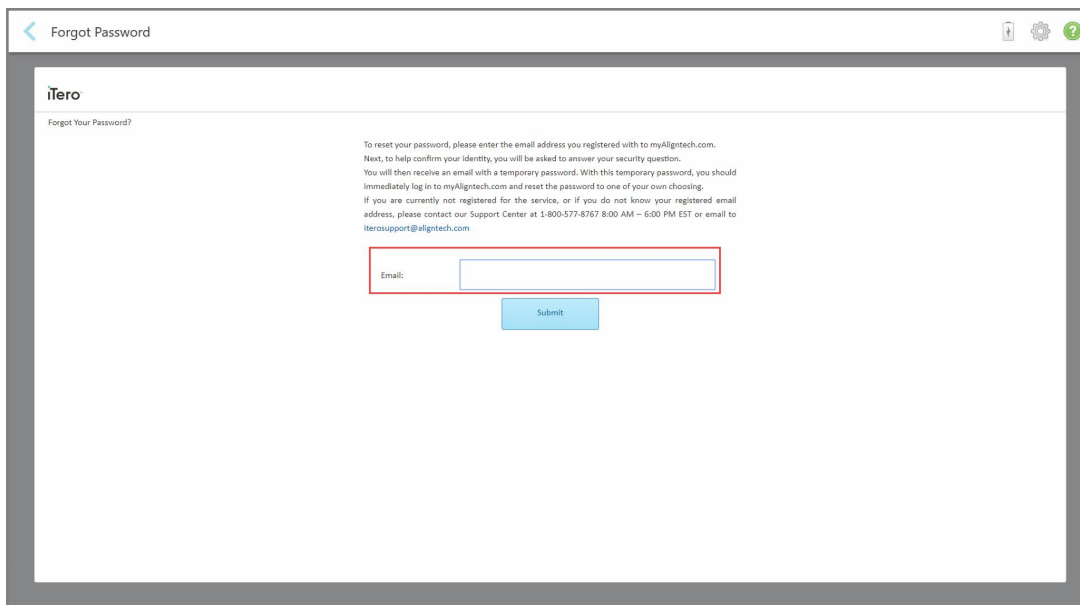

**Figure 35: Email field for forgotten password**

2. In the **Email** field, enter the email address you used to register for myaligntech.com.
3. Tap **Submit**.

Your predetermined security question is displayed.

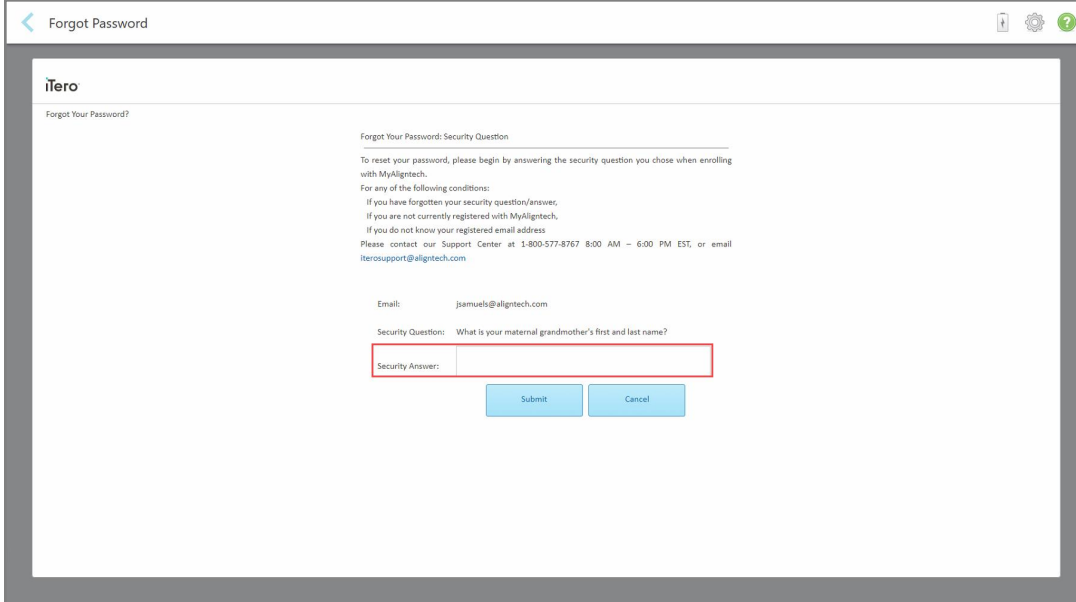

The screenshot shows a mobile application interface for a password reset. At the top, there is a navigation bar with a back arrow and the text 'Forgot Password'. Below this is the iTero logo and the heading 'Forgot Your Password?'. The main content area contains the following text: 'Forgot Your Password: Security Question', 'To reset your password, please begin by answering the security question you chose when enrolling with MyAlignTech.', and 'For any of the following conditions: If you have forgotten your security question/answer, If you are not currently registered with MyAlignTech, If you do not know your registered email address'. Below this is the email address 'jsamuels@aligntech.com' and the security question 'What is your maternal grandmother's first and last name?'. A text input field for the 'Security Answer' is highlighted with a red border. At the bottom, there are 'Submit' and 'Cancel' buttons.

**Figure 36: Security answer field**

4. Enter the answer to the security question.  
A temporary password will be sent to you.
5. Use the temporary password to log in to myaligntech.com and then reset your password, according to the iTero password policy described in [iTero password policy](#).
6. If you do not know your registered email address, contact iTero Customer Support.

#### 4.1.1.1 iTero password policy

When changing your password, ensure that your new password meets the following criteria:

- At least eight characters in length
- No spaces
- At least one upper-case letter
- At least one lower-case letter
- At least one number
- Optional: Passwords may include special characters (for example: !, #, \$, %, ^)

### 4.1.2 Installing Windows security updates

In order to support the continuous cyber security of the scanner, whenever the iTerO software is upgraded, any relevant Windows security updates are downloaded to the scanner and must be installed *within 7 days*.

After the Windows security updates have been downloaded, a *Security Updates* window is displayed when logging in to the scanner, notifying you about these upgrades and enabling you to schedule a time the updates should be installed – postponed daily for up to 7 days, immediately, or later the same night.

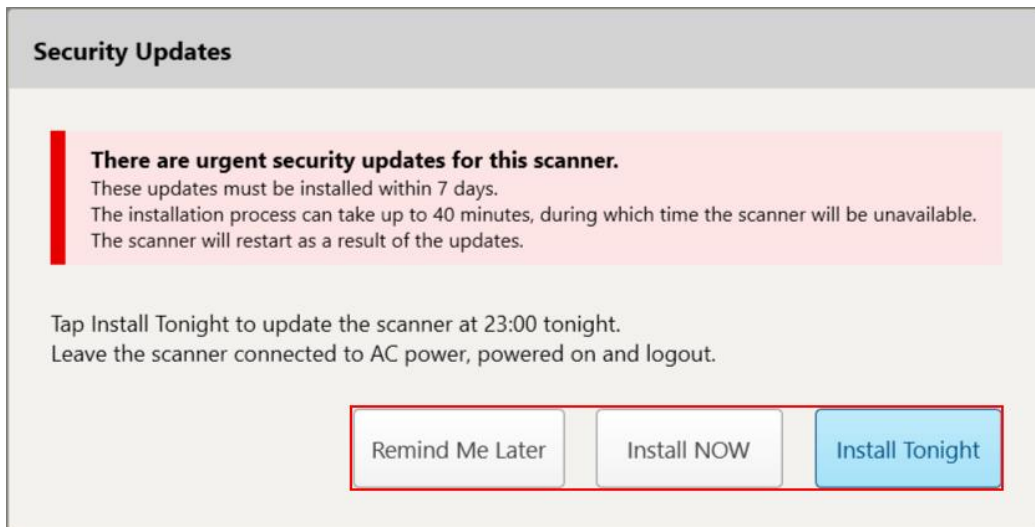

Figure 37: Security Updates window - scheduling options

To install the security updates, the scanner needs to be connected to the AC power and switched on, and you need to log out.

#### Notes:

- Installing the updates should take about 40 minutes, during which time the scanner cannot be used.
- Once the installation starts, it cannot be paused or canceled.
- If you ignore the message and do not install the updates within 7 days, they will be installed automatically the next time the scanner is restarted.

#### To schedule the security-update installation:

1. In the *Security Updates* window, tap one of the following scheduling options:
  - **Remind Me Later:** The installation will be postponed for up to 7 days. For more information, see [Remind Me Later – Postponing the software update installation](#).
  - **Install NOW:** The software updates are installed immediately.
  - **Install Tonight:** The software updates will be installed at 11 PM that night. For more information, see [Install Tonight – Installing the security updates later that night](#).
2. Before the installation is due to take place, make sure that the scanner is connected to the AC power and switched on, and that you have logged out.

If the scanner is not connected to the AC power, you will be prompted to connect it.



Figure 38: Connect the scanner to the AC power

- Plug in the scanner and then tap **Continue**.

The installation starts and a message is displayed showing the installation progress.

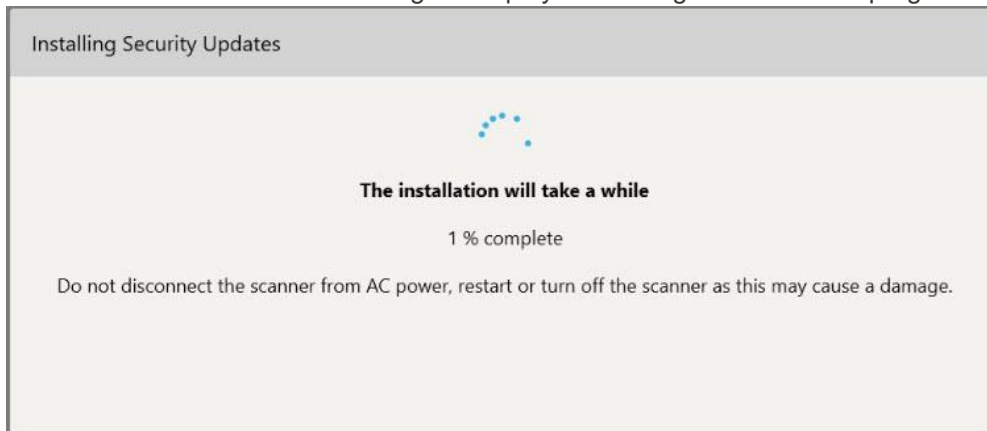

Figure 39: Installation in progress

**Note:** Do not unplug, restart, or turn off the scanner while the security updates are being installed.

Once the security updates have been installed, a success notification is displayed and the scanner restarts.

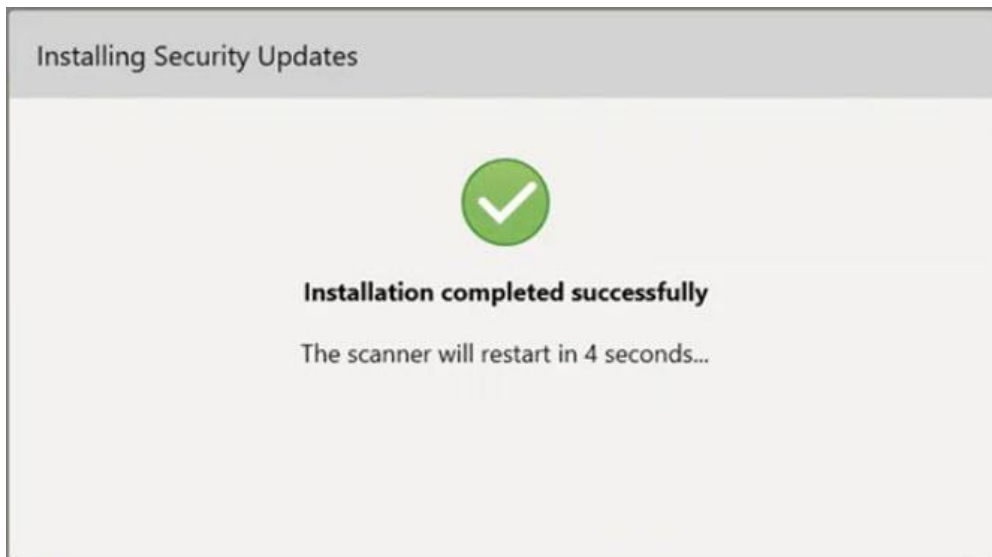

Figure 40: Installation completed successfully

#### 4.1.2.1 Remind Me Later – Postponing the software update installation

You can postpone the security-update installation for up to a week. Every day, the notification will display the number of days remaining until the security updates have to be installed. You can select to postpone the updates, install them immediately, or schedule them for later that night.

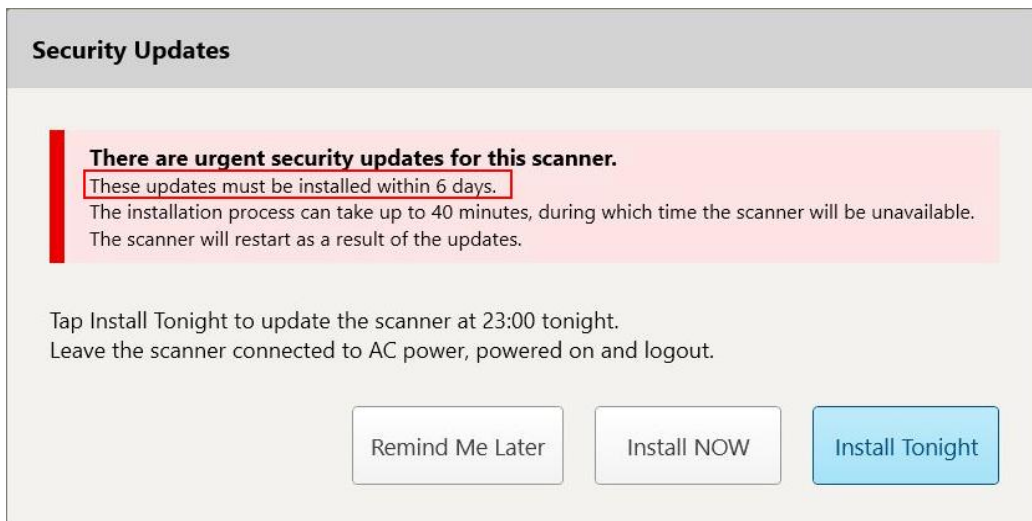

Figure 41: Security updates – number of days until the updates must be installed



On the 7th day, the security updates must be installed. You can select whether to install them immediately, or schedule the installation for later that night, as described below.

**Note:** If you ignore the message and do not install the updates, they will be installed automatically the next time the scanner is restarted.

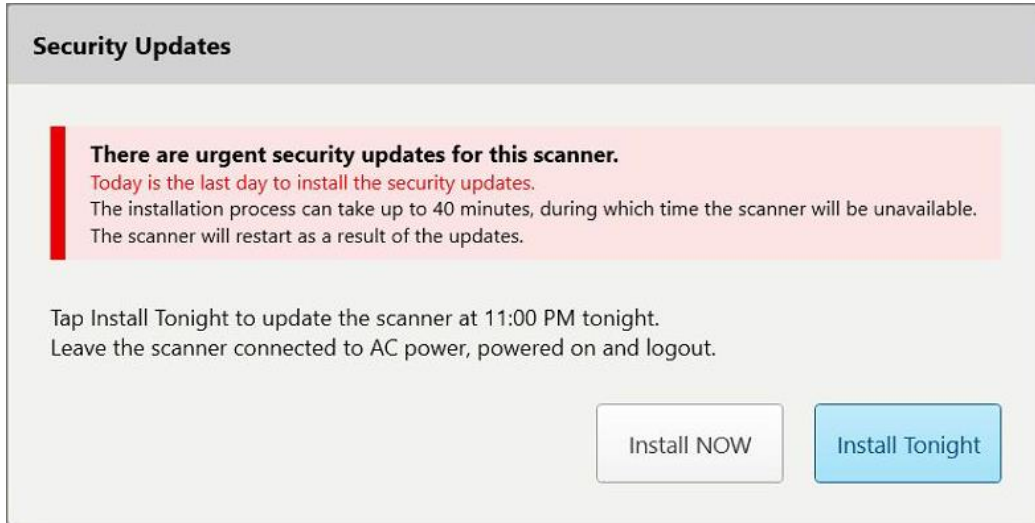
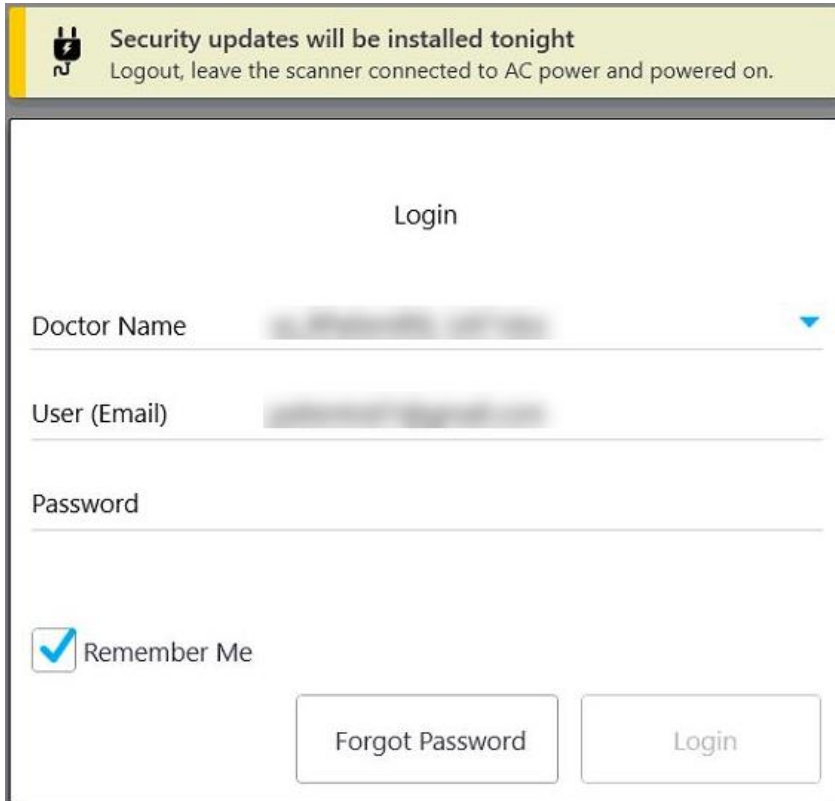

Figure 42: Security updates – last day

#### 4.1.2.2 Install Tonight – Installing the security updates later that night

If you select to install the security updates later that night, a banner is displayed above the scanner *Login* window and the home screen reminding you that the scanner needs to be connected to the AC power and switched on, and that you need to log out.



The image shows a screenshot of the scanner's login interface. At the top, a yellow banner with a plug icon and a lightning bolt icon contains the text: "Security updates will be installed tonight" and "Logout, leave the scanner connected to AC power and powered on." Below the banner is the "Login" window. It features three input fields: "Doctor Name" (with a dropdown arrow), "User (Email)", and "Password". Below the password field is a "Remember Me" checkbox, which is checked. At the bottom of the login window are two buttons: "Forgot Password" and "Login".

Figure 43: Security updates notification – Login window

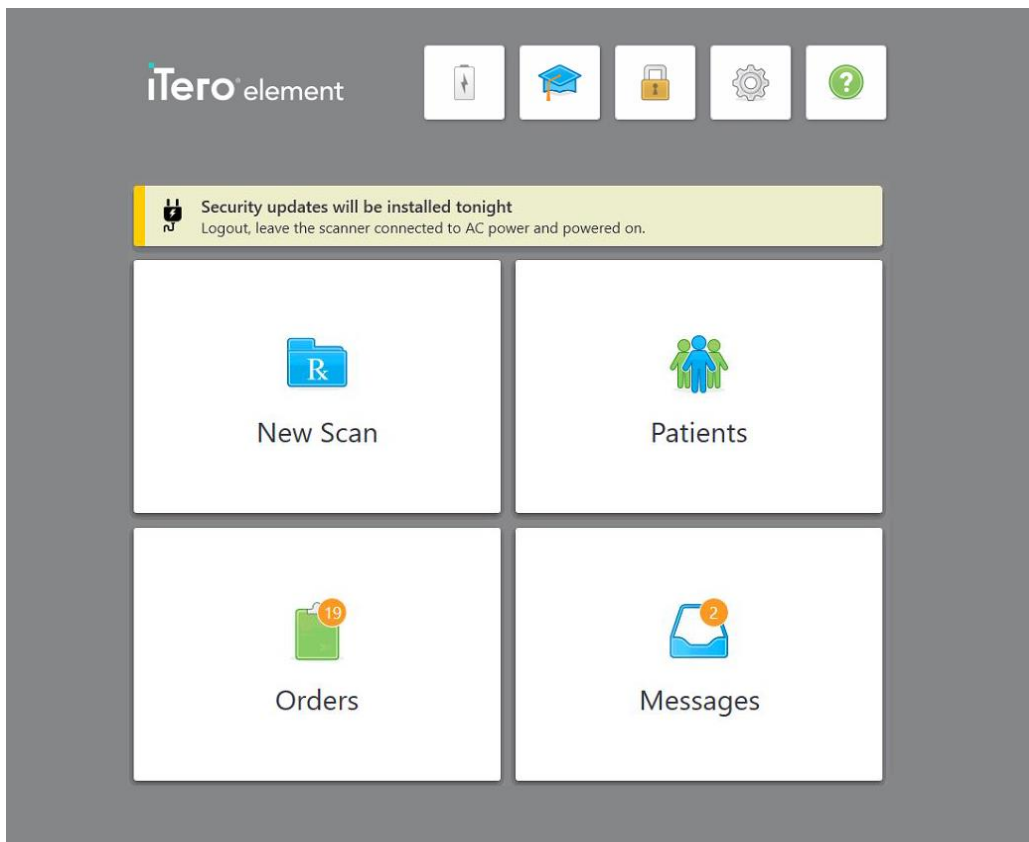



Figure 44: Security updates notification – home screen

## 4.2 Logging out of the scanner

In order to protect the patient information, you should log out of the scanner when it is not in use. Your password will *not* be remembered by the system.

By default, you will be logged out after a predefined period of inactivity, which can be defined in the **Login** settings, described in [Defining the login settings](#).

**To log out of the scanner:**

1. Tap  to return to the home screen.

2. Tap  to log out of the system.

The *Login* window is displayed, ready for the next user to log in to the system.

### 4.3 Shutting down the scanner

It is recommended to shut down the system at the end of each day to allow software updates to be installed.

**Note:** If you do not shut down the scanner correctly, the next time you log on, a message will be displayed notifying you of this and will remain until you acknowledge it. Incorrect shutdown can be caused by letting the battery run down and by pressing the Power button for longer than 4 seconds.

**To shut down the scanner:**

- Press and release the Power button to shut down the system. The Power button is located on the bottom right of the screen in iTerо Element 5D systems and on the top right of the screen in iTerо Element 5D Plus systems.

**Warning:** Pressing the button for more than 4 seconds activates a hard reset, which can cause problems such as gray and blue screens.

### 4.4 Moving the scanner

#### 4.4.1 Moving the iTerо Element 5D wheel-stand configuration scanner

The scanner can be moved between rooms within the office.

**Note:** To ensure maximum system protection, it is recommended to have 2 people move the scanner.

**To move the scanner between rooms:**

1. Ensure that the wand is firmly positioned in the cradle.
2. Unplug the system from the wall outlet.
3. Move the system to its new location and plug it into a wall outlet.

#### 4.4.2 Transporting the iTerо Element 5D laptop-configuration imaging system

To ensure maximum system protection, it is recommended to follow the instructions below when transporting the system:

1. Attach the blue protective sleeve onto the wand.

2. Place all items in the supplied carrying case to move the system between offices.



Figure 45: iTero Element 5D laptop-configuration imaging system in the supplied carrying case

3. Make sure the case is kept dry to protect the system components from humidity.

#### 4.4.3 Moving the iTero Element 5D Plus cart-configuration scanner

The scanner can be moved between rooms within the office and while you are seated, with a patient.

##### To move the scanner between rooms:

1. Ensure that the wand is firmly positioned in the cradle.
2. Unplug the system from the wall outlet and carefully wrap the power cable around the upper handle, to prevent the cable from being caught between the wheels.
3. Using the upper handle, move the system to its new location and plug it into a wall outlet.

**Note:** If the scanner needs to be lifted, lift it using the upper handle and the post.

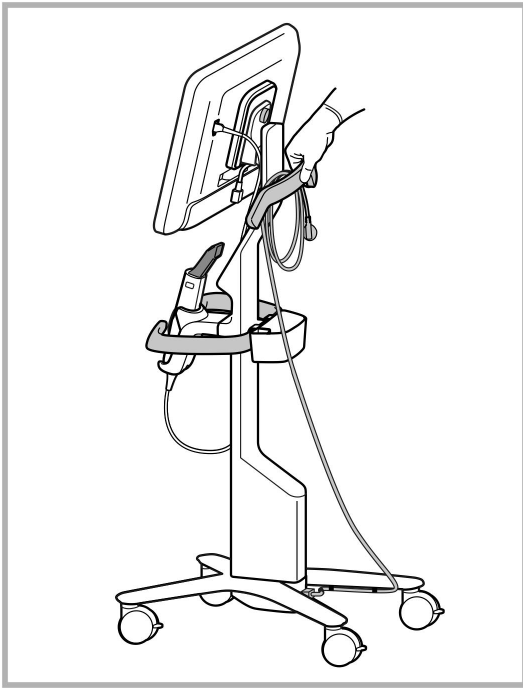

Figure 46: Moving the scanner

**To move the cart-configuration scanner while in a seated position:**

- Use the main handle to move the scanner.
- The screen height is optimized for a more ergonomic experience while seated. If required, you can adjust the tilt of the screen.

**Note:** Do not use the wand or the wand cable to move the scanner, in order to prevent the scanner from toppling over or damage to the cable.

#### 4.4.4 Carrying the iTerо Element 5D Plus mobile-configuration scanner within the clinic

The mobile-configuration scanner can be carried between rooms within the clinic as well as transported between clinics.

When carrying the scanner, you should always move the handle to the carrying position and wind the wand cable around the cradle.

**To carry the mobile-configuration scanner within the clinic:**

1. Ensure that the wand is firmly positioned in the cradle.
2. Disconnect the power cable from the mains and then from the back of the computing unit.
3. While holding the computing unit with one hand, slide the locking latch to unlock the handle and then move the handle to the carrying position. For more information, see [Moving the scanner within the clinic](#).

4. Loosely wrap the cable around the cradle for easy and safe portability.

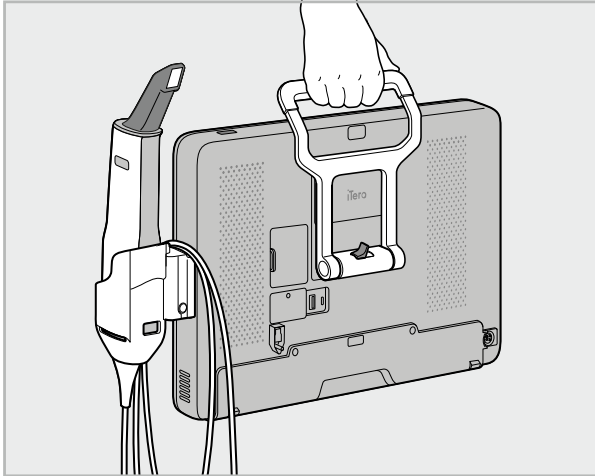

Figure 47: Carrying the scanner between rooms within the clinic

#### 4.4.5 Transporting the iTero Element 5D Plus mobile-configuration scanner between clinics

When transporting the mobile-configuration scanner between clinics, always pack the scanner in its supplied trolley. For more details, see [Using the trolley for transportation](#).

##### To transport the scanner between clinics:

1. Turn off the scanner.
2. Disconnect the power cable from the mains and then from the back of the computing unit.
3. Disconnect the scanner components and pack them in their designated compartments in the trolley. For more information, see [Using the trolley for transportation](#).
4. Close and secure the trolley flap and then close the trolley by lifting the side with the fastened flap and zipping it closed.



Figure 48: Transporting the scanner between clinics

- If required, use the optional protective cover to protect the trolley against wear and tear and adverse weather conditions. For more information, see [Optional protective trolley cover](#).

## 4.5 User interface

The iTerio system provides an intuitive user interface for performing digital scans for Restorative or Orthodontic use. The touch screen and wand buttons are used to respond to screen instructions during the scanning process.

For a list of the touch-screen gestures that can be used, see [Touch-screen gestures](#).

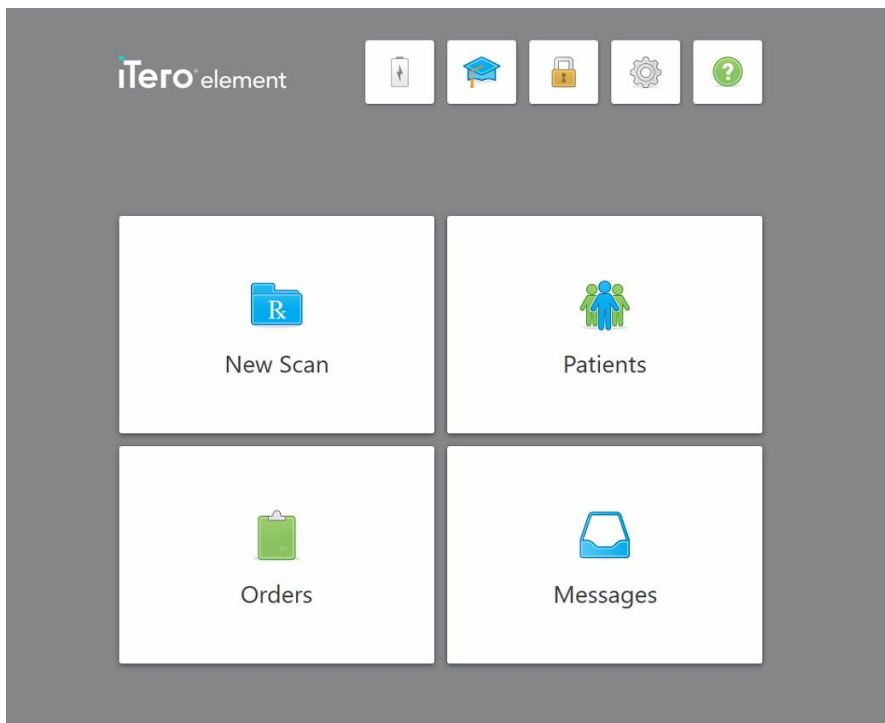

Figure 49: iTerio home screen

The following buttons are displayed on the home screen:



Displays the status of the external battery:

- A lightning bolt indicates that the scanner is connected to the power, and the battery is charging.
- When using battery power, the remaining charge level is displayed on the battery icon. When the remaining charge level falls below 25%, the battery

icon is displayed in red.





- Tap the battery icon to view the percentage of remaining charge:

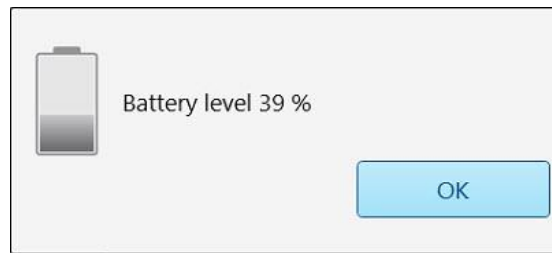

Figure 50: Percentage of remaining battery charge



**Learning Center:** Tap to access training materials and educational videos for the iTero scanner.



**Lock:** Tap to log out of your account whenever the scanner is not in use, as described in [Logging out of the scanner](#). This helps ensure that the dental practice is HIPAA compliant, and that all medical information is secure.

**Tip:** You should lock the system while cleaning it, in order to avoid unintended entries.



**Settings:** Tap to adjust the scanner preferences, for example, for wand configuration, localization, user settings, and more. For more information, see [Defining the scanner settings](#).



**Help:** Tap to display a translucent Help overlay with hints to aid in the navigation of features and tools.

In this view, the **Help** button changes to two new buttons – e-manual and Customer Support:

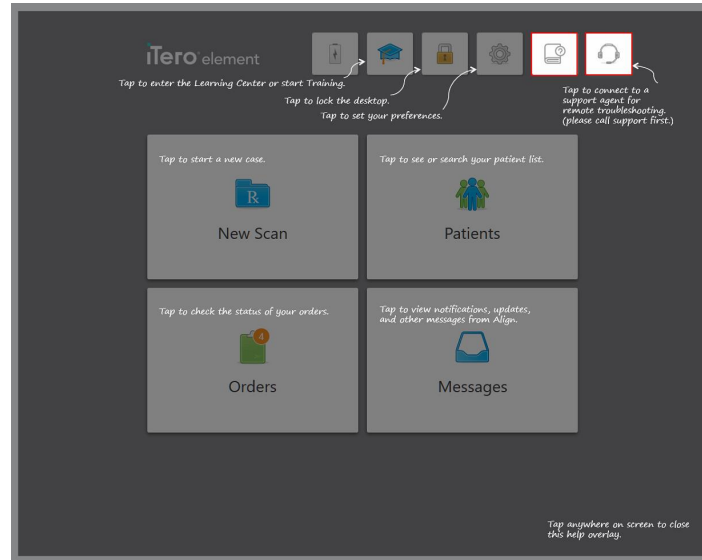

**Figure 51:** Help overlay including the e-manual and Customer Support buttons



Tap to access the relevant e-manual.



Tap for remote assistance from Customer Support. Customer Support is available from every Help overlay.

**Note:** Please call Customer Support before trying to connect remotely.

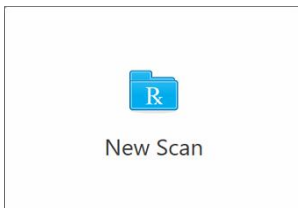

**New Scan:** Tap to open the *New Scan* window to fill in the Rx before starting a new scan. For more information, see [Starting a new scan](#).



**Patients:** Tap to view the *Patients* page with a list of all patients registered in your iTero system, and if relevant, their chart number, date of birth, and the date of their last scan. For more information, see [Working with patients](#).

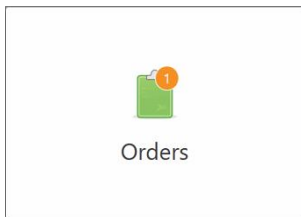

**Orders:** Tap to display a list of all your orders. For more information, see [Working with orders](#).

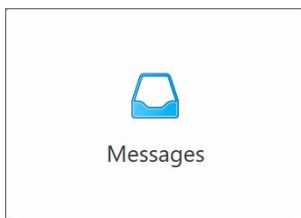

**Messages:** Tap to view the messages from Align Technology. For more information, see [Viewing messages](#).

The **Battery** and **Settings** buttons are displayed on each of the scanner windows as well, as described in [Scanner toolbar](#).

### 4.5.1 Scanner toolbar

The following toolbar is displayed on the top of each of the scanner windows:



Figure 52: Scanner toolbar

The 4 center buttons indicate the status of the scan process. Tap the buttons to navigate through the scan flow.



Tap to return to the home screen.

New Scan

Displays the current stage in the scanning process, also indicated by the relevant highlighted button in the toolbar.



Tap to return to the *New Scan* window to view the Rx, as described in [Filling in the Rx](#).



Tap to move to Scan mode to scan the patient, as described in [Scanning the patient](#).



Tap to move to View mode to view the scanned model, as described in [Viewing the scan](#).



Tap to send the scanned model to the lab or your chairside milling software, as described in [Sending the scan](#).



Displays the status of the external battery:

- A lightning bolt indicates that the scanner is connected to the power, and the battery is charging.
- When using battery power, the remaining charge level is displayed on the battery icon. When the remaining charge level falls below 25%, the battery icon is displayed

in red .

- Tap the battery icon to view the percentage of the remaining charge:

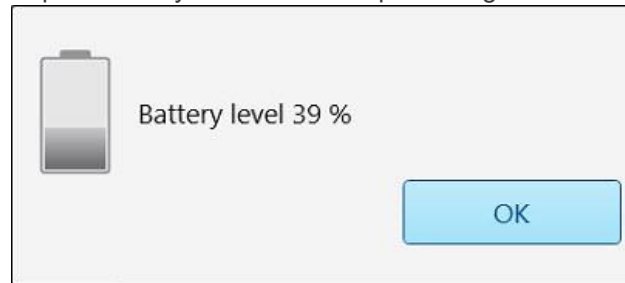

Figure 53: Percentage of remaining battery charge



Tap to adjust the scanner preferences, for example, for wand configuration, localization, user settings, and more.

For more information on the Settings preferences, see [Defining the scanner settings](#).



Tap to display a translucent Help overlay with hints to aid in the navigation of features and tools.

In this view, the **Help** button changes to two new buttons – e-manual and Customer Support:

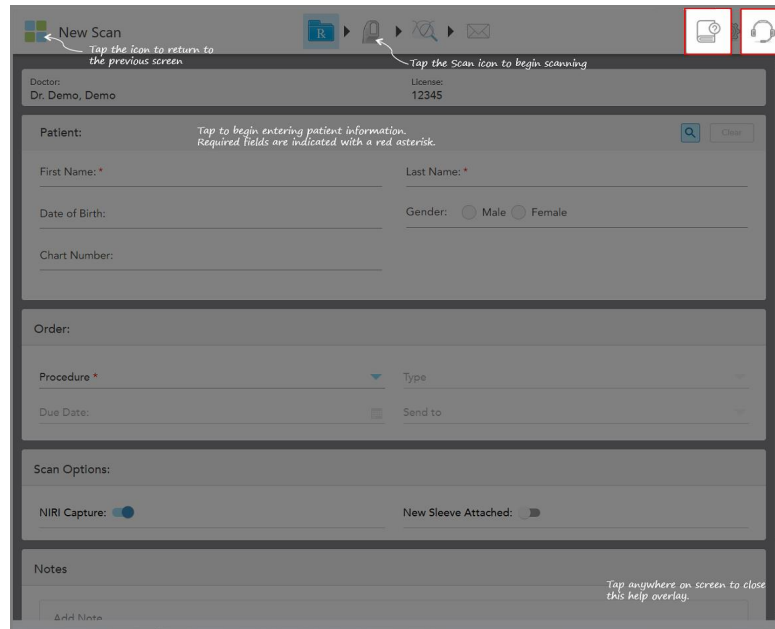

**Figure 54:** Help overlay including e-manual and Customer Support buttons



Tap to access the relevant e-manual.



Tap for remote assistance from Customer Support. Customer Support is available from every Help overlay.

**Note:** Please call Customer Support before trying to connect remotely.

## 4.5.2 Touch-screen gestures

The iTero software supports touch-screen (also known as multi-touch) gestures. These gestures are predefined motions used to interact with multi-touch devices.

Examples of common touch-screen gestures:



Tap



Double tap



Long press



Scroll



Rotate



Swipe



Pan



Zoom out



Zoom in

## 4.6 Defining the scanner settings

The scanner settings enable you to define your preferences and the settings that are displayed by default when you use the scanner.

**To define the scanner settings:**

1. Tap the  button.

The *Settings* window is displayed.

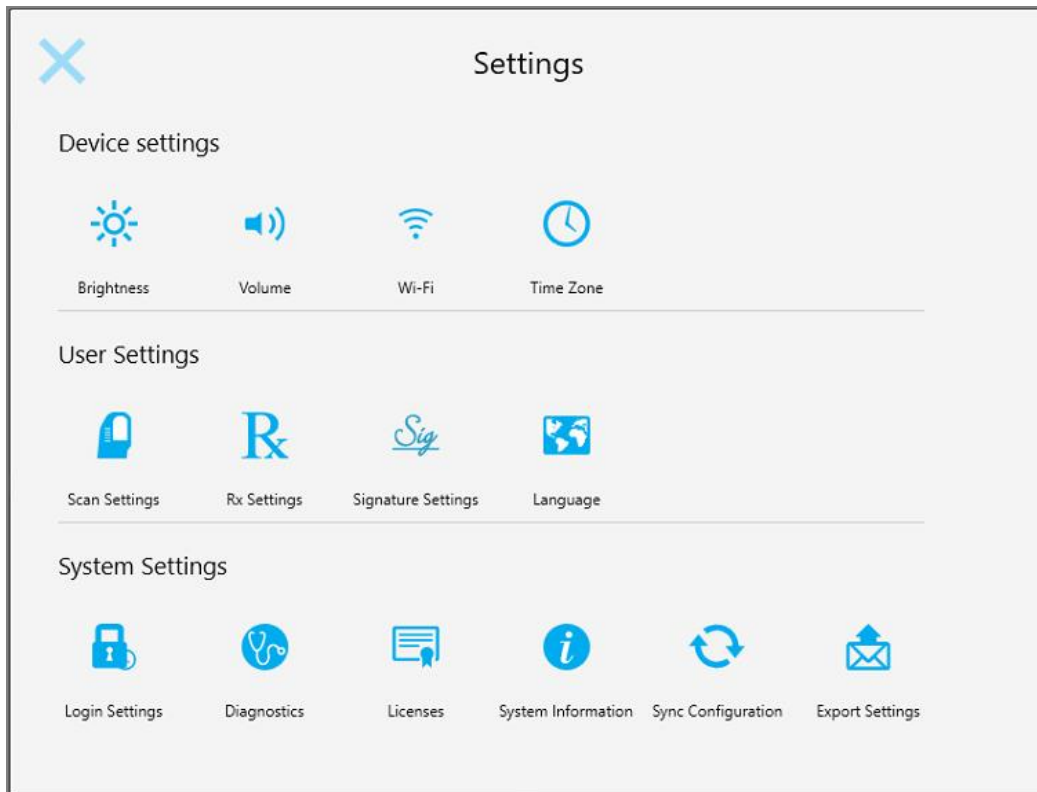

Figure 55: Settings window

2. Tap the settings you would like to define.
  - [Defining the Device settings](#)
  - [Defining the User settings](#)
  - [Defining the System settings](#)

The relevant window opens.

3. Make your required changes and then tap  to save the changes and return to the *Settings* window.

#### 4.6.1 Defining the Device settings

The Device settings enable you to define the brightness, volume, Wi-Fi, and time-zone settings for the scanner.

##### 4.6.1.1 Defining the default brightness setting

To define the default brightness setting, tap the **Brightness** button, move the slider to the required brightness level, and then tap  to save the changes and return to the *Settings* window.



Figure 56: Brightness settings

##### 4.6.1.2 Defining the default volume setting

To define the default system volume, tap the **Volume** button, move the slider to the required volume level, and then tap  to save the changes and return to the *Settings* window.



Figure 57: Volume settings

In addition to the system sounds, the volume settings define the volume for the content from the Learning

Center .



### 4.6.1.3 Defining the Wi-Fi settings

The first time you connect the scanner to the clinic's Wi-Fi network, you will need to add the password. After that, by default, the scanner will connect automatically. If you want to connect to a different Wi-Fi network, select the new network and enter the relevant password.

#### To reconnect to a Wi-Fi network:

1. Tap the **Wi-Fi** button.

A list of nearby Wi-Fi networks is displayed.

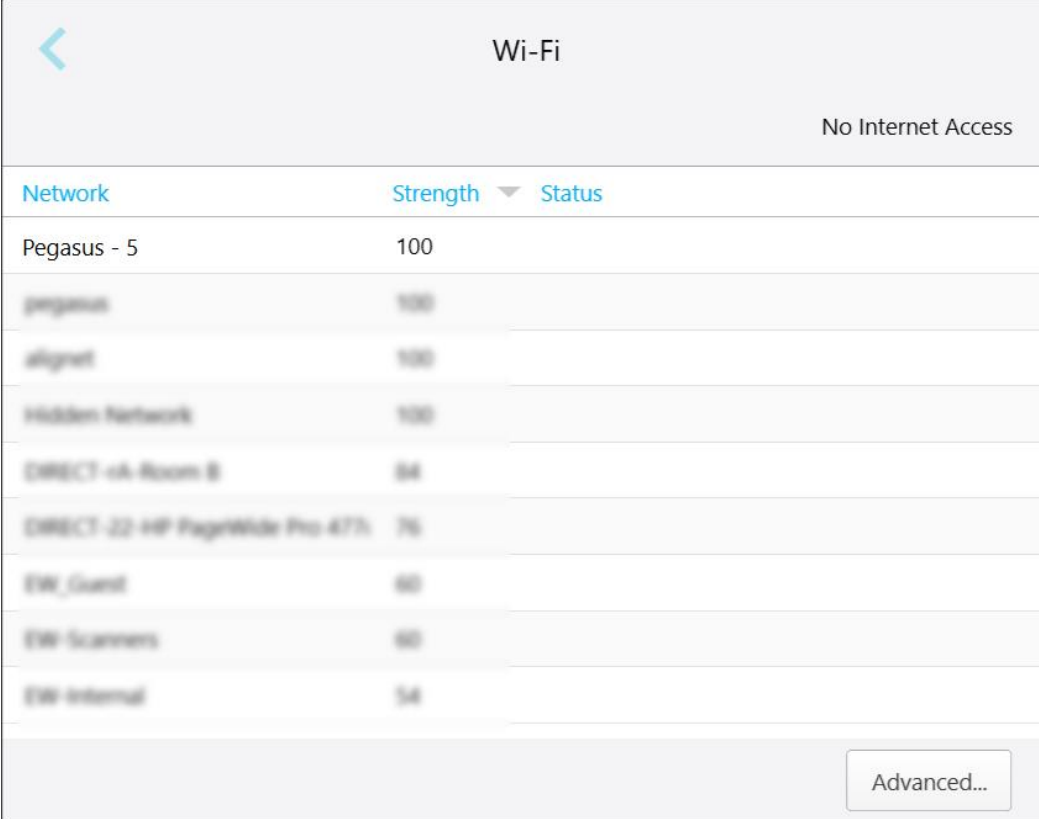

The screenshot shows a mobile application interface for Wi-Fi settings. At the top, there is a back arrow on the left, the title "Wi-Fi" in the center, and "No Internet Access" on the right. Below the title is a table with three columns: "Network", "Strength", and "Status". The table lists several networks with their respective signal strengths. At the bottom right, there is a button labeled "Advanced...".

Network	Strength	Status
Pegasus - 5	100	
pegasus	100	
alignet	100	
Hidden Network	100	
DIRECT -A Room B	84	
DIRECT -D HP PageWide Pro 475	76	
EW_Guest	60	
EW_Scanners	60	
EW-Internal	54	

Figure 58: List of nearby Wi-Fi networks

2. Select the clinic network, for example, Pegasus - 5, and then tap **Connect**.

3. Enter the network security key (password) in the window that opens and then tap **Connect**.

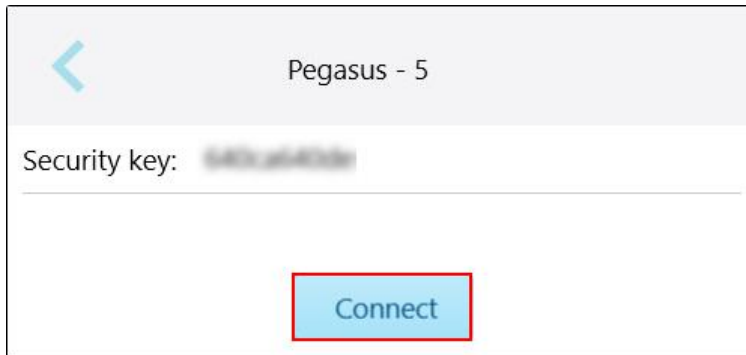

Figure 59: Connecting to the clinic Wi-Fi network

The scanner connects to the Wi-Fi network, and the status changes to **Connected**.

4. If you do not want to connect to the network automatically, tap the network you are connected to and then tap **Forget**.

You will need to select the required network and enter the Wi-Fi password the next time you want to connect.

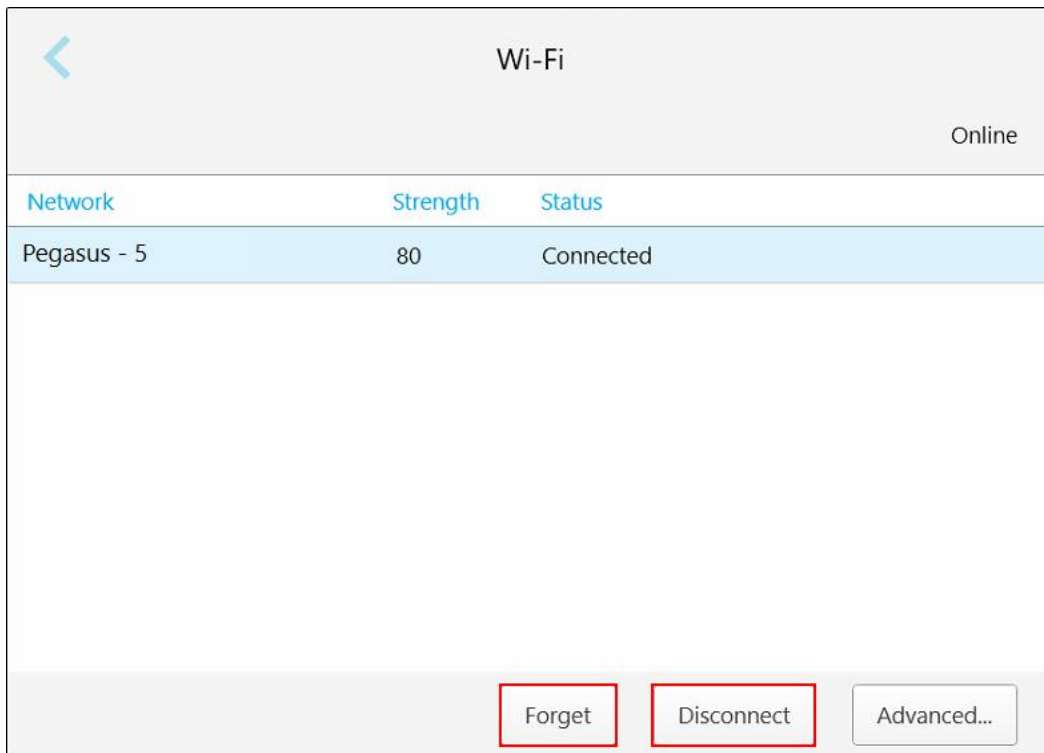



Figure 60: Forgetting or Disconnecting from the network

5. To disconnect from the network, tap **Disconnect**.
6. Tap  to save the settings and return to the *Settings* window.

#### 4.6.1.4 Defining the time zone

To define the time zone, tap the **Time Zone** button, select the time zone from the drop-down list, and then tap  to save the changes and return to the *Settings* window.

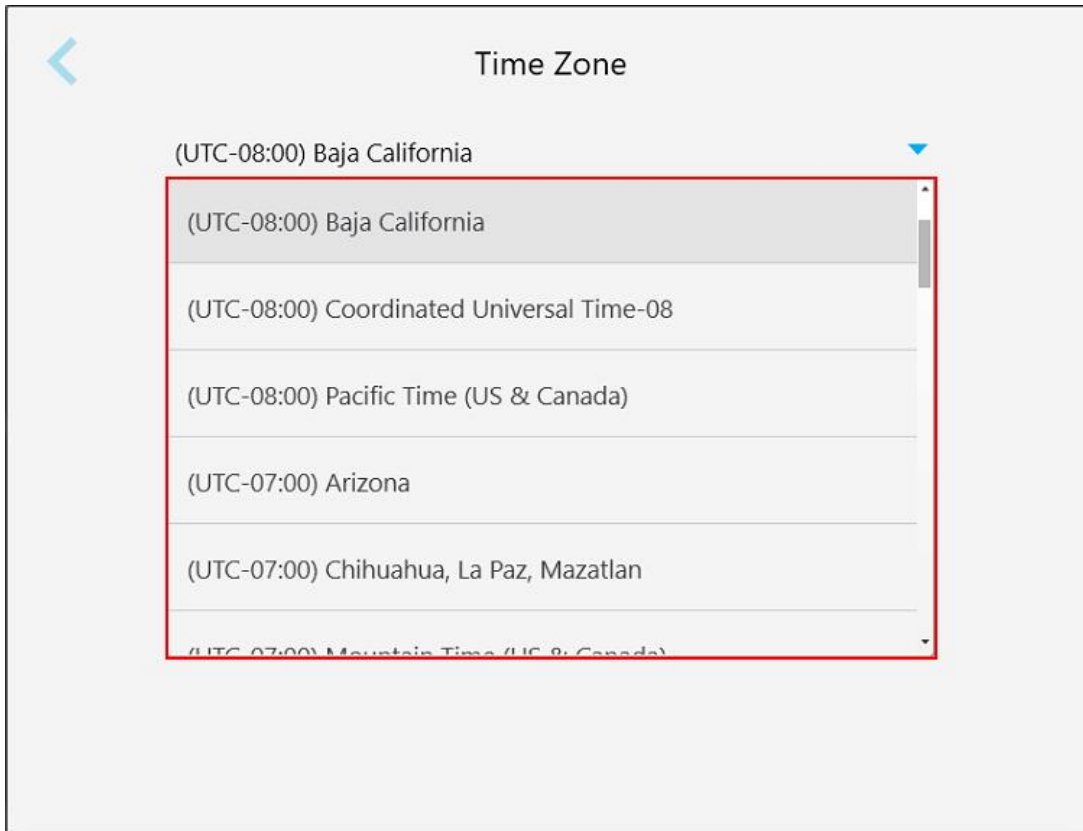

Figure 61: Time zone settings

**Note:** The time zone settings can be accessed only when you are logged in to the scanner.

## 4.6.2 Defining the User settings

The User settings enable each user to define the settings that are displayed by default when the specific user logs in to the scanner.

### 4.6.2.1 Defining the scan settings

You can define the default settings that are taken into account when scanning a patient.

**To define the scan settings:**

1. Tap the **Scan Settings** button.

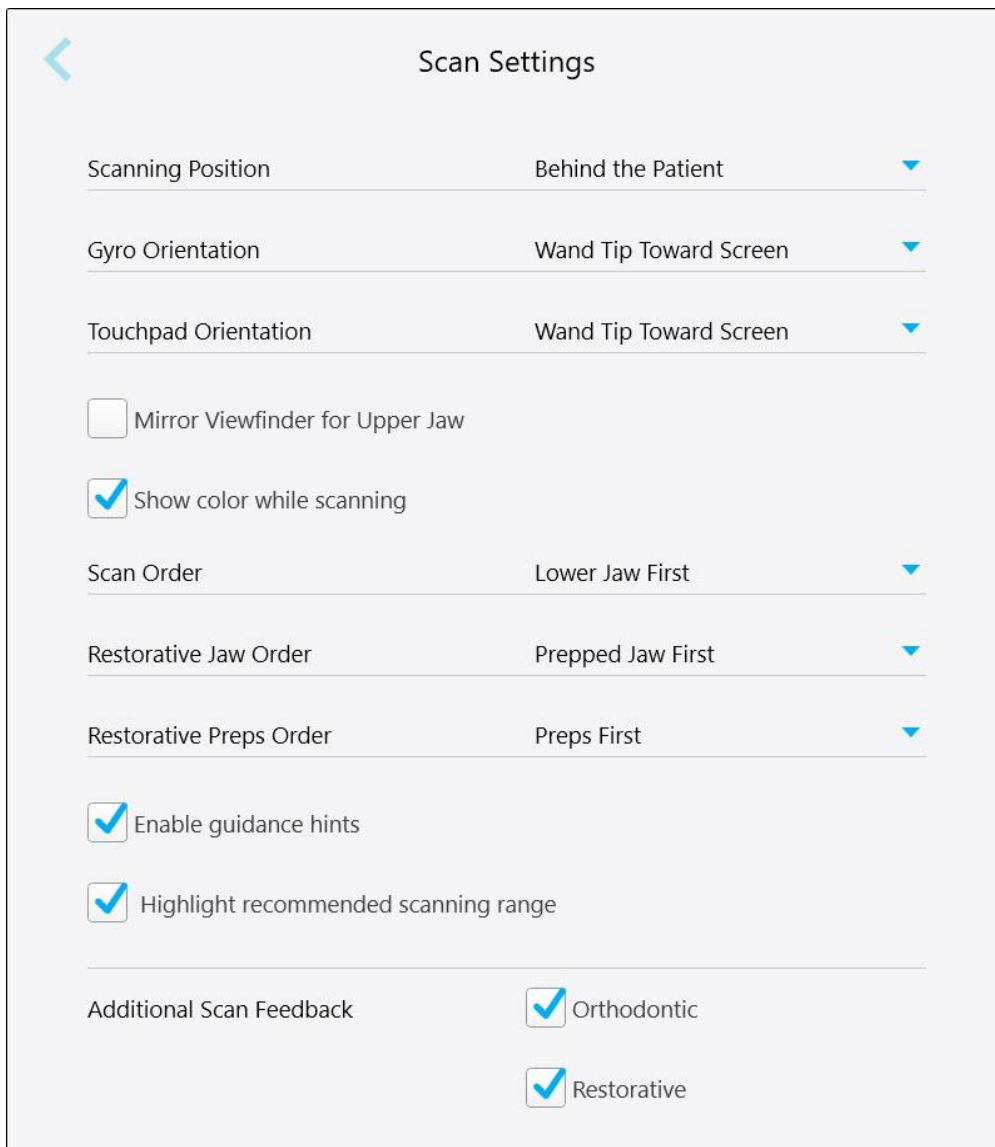

Figure 62: Scan Settings window

2. Select the default scanning preferences from the *Scan Settings* window.

Scan setting	Scan options
<b>Scanning Position</b>	Select your position while scanning the patient: <ul style="list-style-type: none"> <li>• Behind the patient</li> <li>• In front of the patient</li> </ul>
<b>Gyro Orientation</b>	Select the default gyro orientation: <ul style="list-style-type: none"> <li>• Wand Tip Toward Screen</li> <li>• Wand Base Toward Screen</li> </ul>
<b>Touchpad Orientation</b>	Select the default touchpad orientation: <ul style="list-style-type: none"> <li>• Wand Tip Toward Screen</li> <li>• Wand Base Toward Screen</li> </ul>
<b>Mirror Viewfinder for Upper Jaw</b> check box	Select this check box to define the orientation of the viewfinder when scanning the upper jaw.
<b>Show color while scanning</b> check box	Select this check box to show the 3D model in color while scanning, by default.
<b>Scan Order</b>	Select the order in which to scan the jaws: <ul style="list-style-type: none"> <li>• Upper Jaw First</li> <li>• Lower Jaw First</li> </ul>
<b>Restorative Jaw Order</b>	Select the order in which to scan the jaws for fixed restorative procedures: <ul style="list-style-type: none"> <li>• Opposite Jaw First</li> <li>• Prepped Jaw First</li> </ul>
<b>Restorative Preps Order</b>	Select the order in which to scan the prepped teeth and the arches in fixed restorative procedures: <ul style="list-style-type: none"> <li>• Preps First</li> <li>• Arch First</li> <li>• No Guidance</li> </ul>
<b>Enable guidance hints</b> check box	Select this check box to display guidance when scanning, as described in <a href="#">Scanning guidance</a> .

## Scan setting

**Highlight recommended scanning range** check box

## Scan options

Select this check box to highlight only the scanning range on the navigation controls.

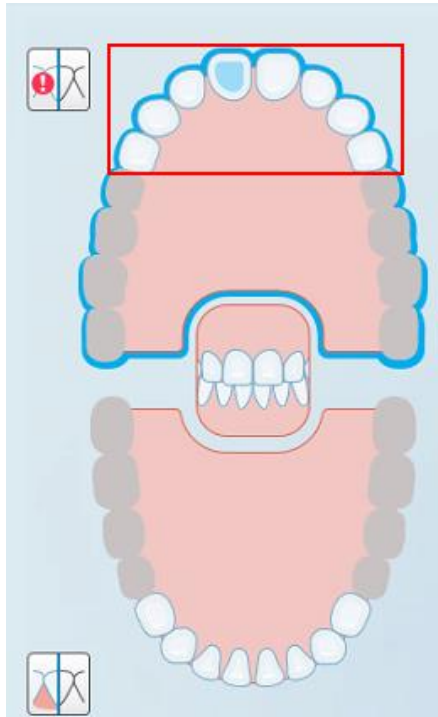



Figure 63: Only the scanning range is highlighted

**Additional Scan Feedback**

Select the relevant check boxes to display areas of missing anatomy while scanning, as described in [Additional scan feedback](#).

- Orthodontic
- Restorative

3. Tap  to save the changes and return to the *Settings* window.

### 4.6.2.2 Defining the Rx settings

You can define the settings that are displayed by default when you open the *Scan Details* window to fill in a new Rx.

**To define the Rx settings:**

1. Tap the **Rx Settings** button.

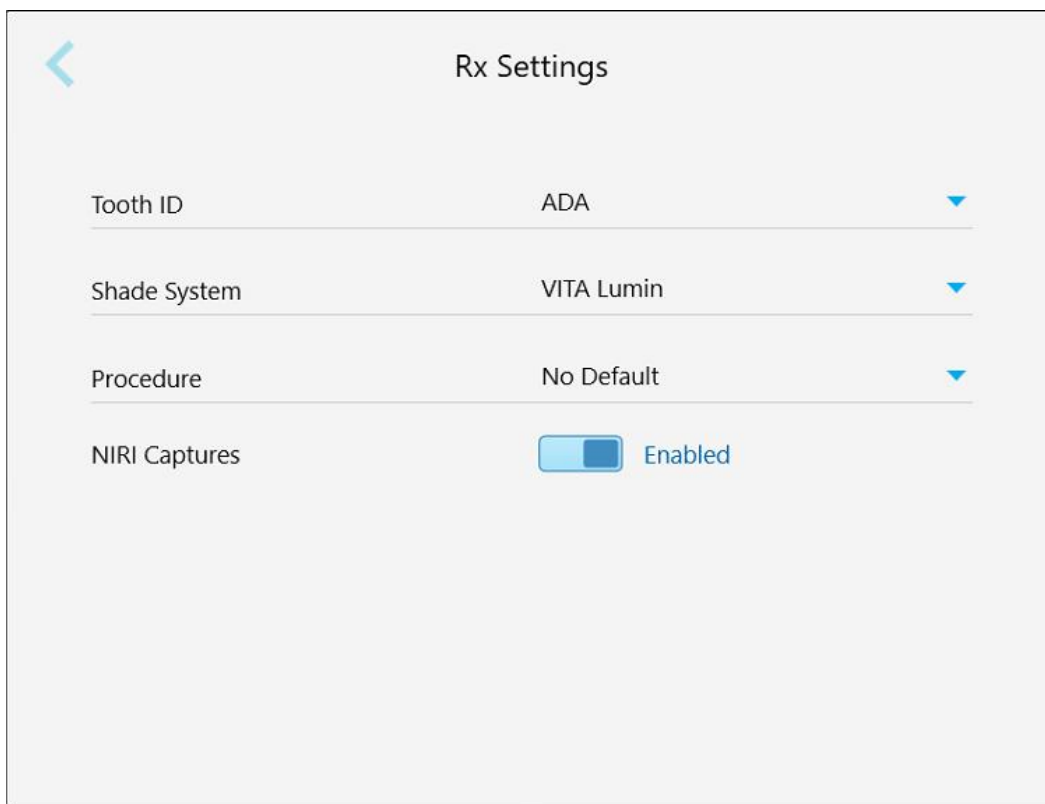



Figure 64: Rx Settings window

2. Select the default Rx preferences from the *Rx Settings* window.

Rx setting	Rx options
<b>Tooth ID</b>	Select the default tooth ID system: <ul style="list-style-type: none"> <li>• FDI</li> <li>• ADA</li> <li>• Quadrant</li> </ul>
<b>Shade System</b>	Select the default shade system: <ul style="list-style-type: none"> <li>• VITA Lumin</li> <li>• VITApan 3D Master</li> <li>• Other</li> </ul>
<b>Procedure</b>	Select the default procedure: <ul style="list-style-type: none"> <li>• Appliance</li> <li>• Denture/Removable</li> <li>• Fixed Restorative</li> <li>• Implant Planning</li> <li>• Invisalign</li> <li>• Study Model/iRecord</li> <li>• No Default</li> </ul> <p><b>Note:</b> The list of available procedures changes according to your iTerio subscription package.</p>
<b>NIRI Captures</b>	Select whether NIRI data should be disabled by default, as described below. <p><b>Note:</b> This section is not relevant for iTerio Element 5D Plus Lite systems.</p>

3. Tap  to save the changes and return to the *Settings* window.

#### 4.6.2.3 Disabling NIRI data capture for all scans

**Note:** This section is not relevant for iTerio Element 5D Plus Lite systems.

When patients are scanned, the NIRI data is captured by default. However, you can disable capturing the NIRI data. In this case, none of the NIRI features will be displayed in the GUI, and NIRI data will not be captured, saved, or sent.

If required, NIRI capture can also be disabled for a specific scan, as described in [Disabling NIRI data capture](#).



**To disable NIRI data capture, by default:**

1. In the *Settings* window, tap **Rx Settings**.
2. In the *Rx Settings* window, turn off the **NIRI Captures** toggle option.

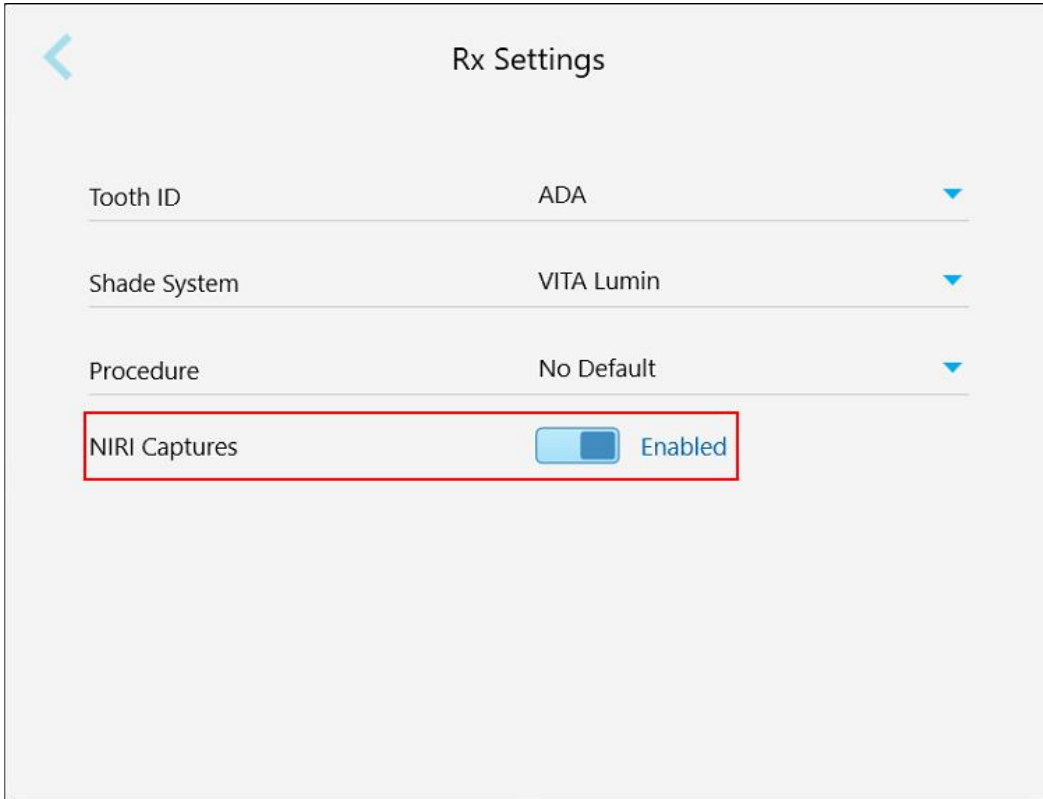

Figure 65: Rx Settings window – NIRI Captures option enabled

A confirmation message is displayed notifying that NIRI will be disabled, by default, for all future scans.

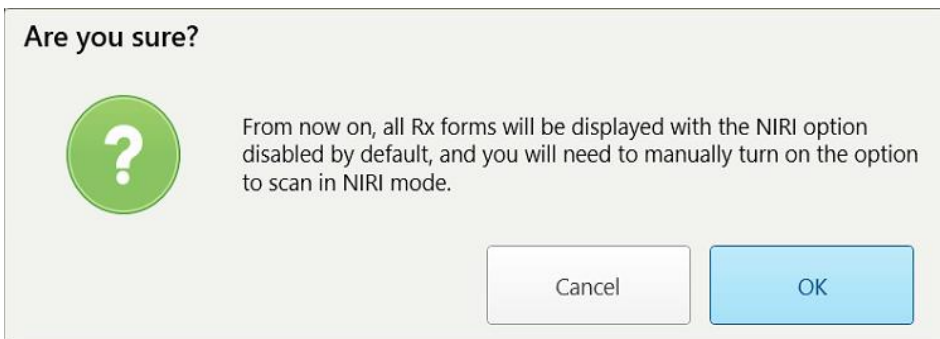

Figure 66: Disable NIRI confirmation

3. Tap **OK** to confirm.

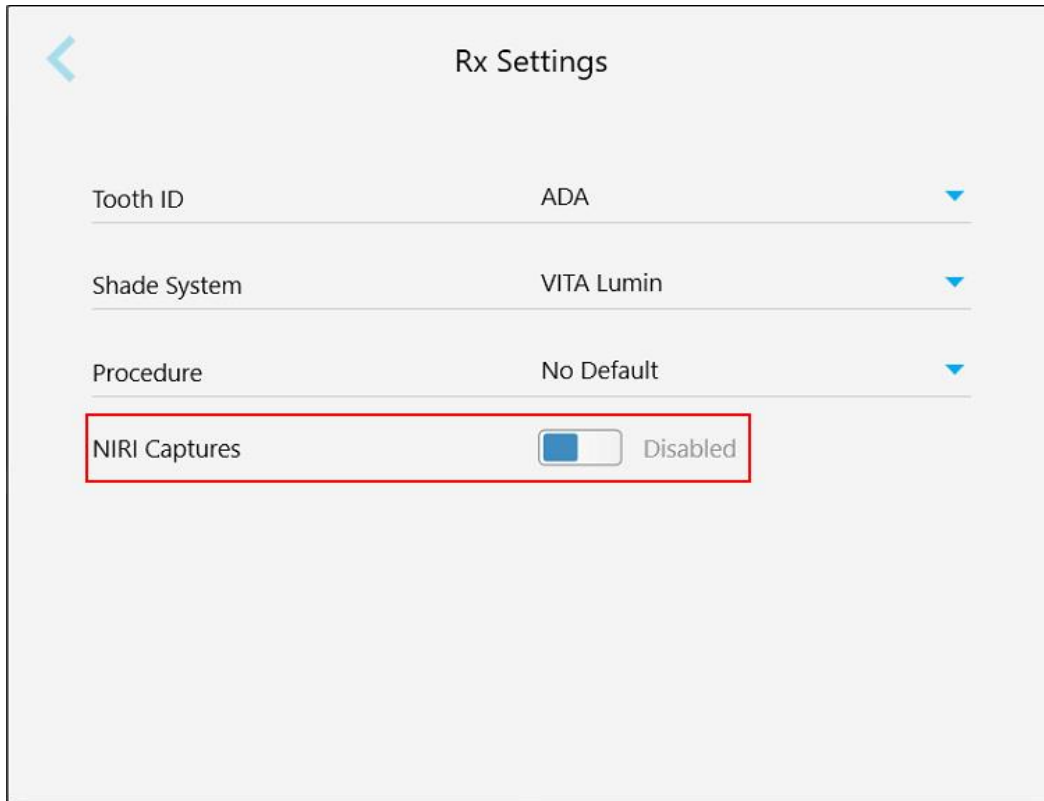

Figure 67: Rx Settings window – NIRI Captures option disabled

#### 4.6.2.4 Defining the signature settings

You can define the default settings that are displayed when sending an order to the lab.

**To define the signatures settings:**

1. Tap the **Signature Settings** button.

Figure 68: Signature Settings window

2. Define the default signature settings.

Signature setting	Signature options
<b>License</b>	Add your license number.
<b>Signature</b>	Add your signature.
<b>Signature Usage</b>	Select one of the following signature options: <ul style="list-style-type: none"> <li>• Sign once and save for use with each Rx.</li> <li>• Do not save my signature (requires a signature for each Rx).</li> <li>• Disable this function (for this user only).</li> </ul>

3. Tap  to save the changes and return to the *Settings* window.

### 4.6.2.5 Defining the language settings

Tap the **Language** button, select the required language from the drop-down list, and then tap  to save the changes and return to the *Settings* window.

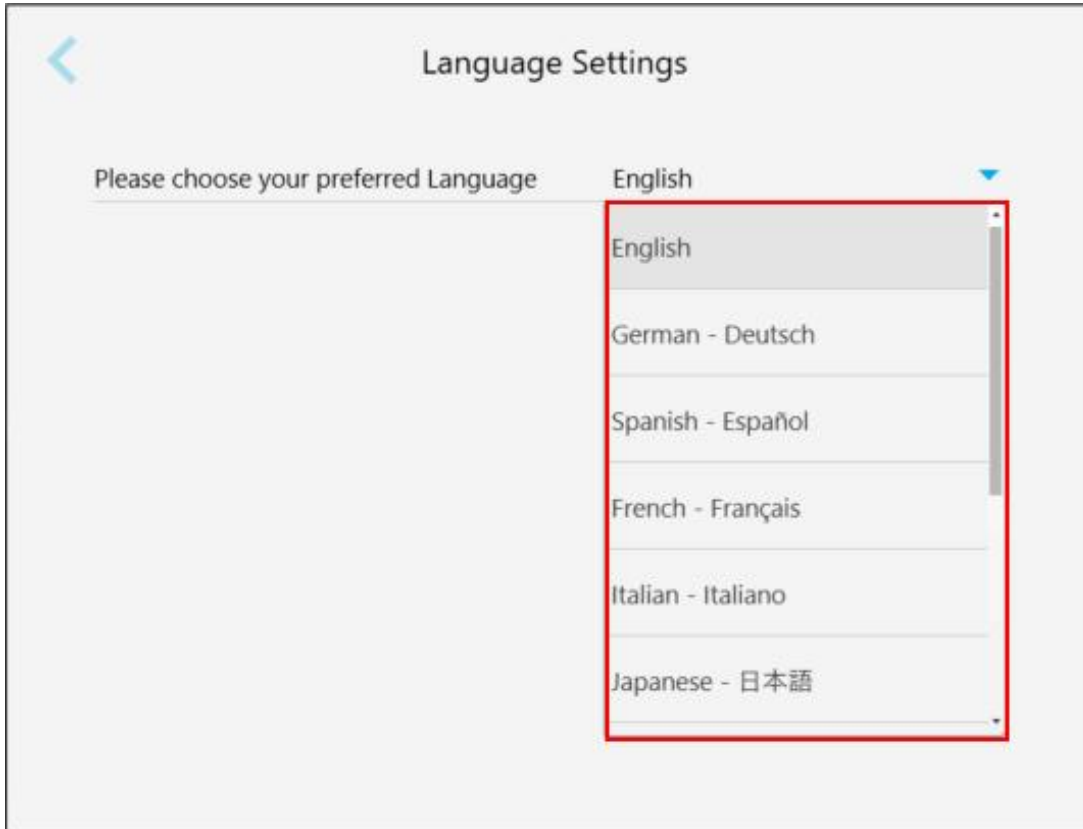

Figure 69: Language Settings window

### 4.6.3 Defining the System settings

The System settings enable you to set the login settings, run diagnostics, view the licenses, view the system information, synchronize new updates from the server, and define the export settings.

#### 4.6.3.1 Defining the login settings

In order to comply with privacy and security regulations, you will be logged out of the scanner after a predefined period of inactivity. By default, this time is set to 1 hour, but you can change it if required.

**Notes:**

- To ensure patient privacy, it is recommended to not increase the inactivity period to more than the default 1 hour.
- You will not be logged out of the scanner while the scanner is in Scan mode.

**To define the period of inactivity:**

1. Tap the **Login Settings** button.

The *Login Settings* window is displayed.

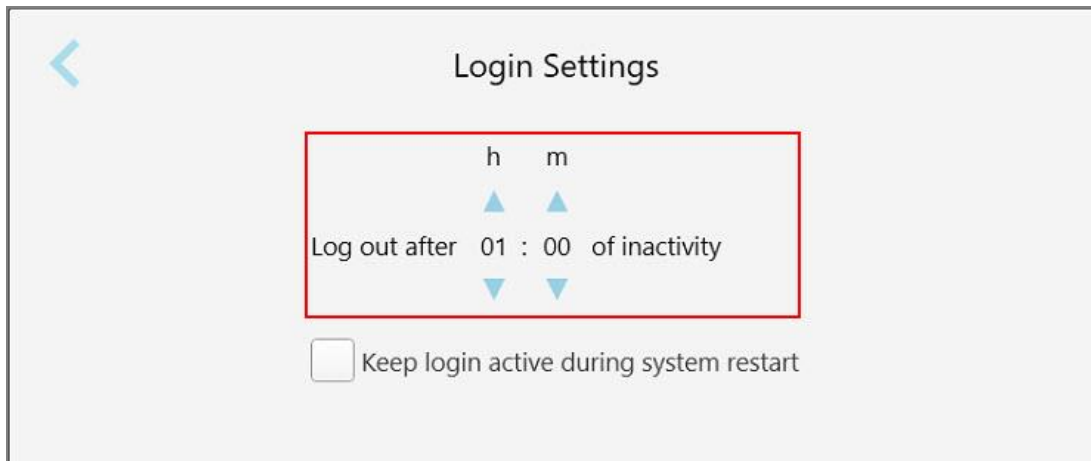



Figure 70: Login Settings window

2. Select the period of inactivity after which the user will be logged out of the scanner. (Min time: 10 minutes, Max time: 8 hours)
3. Select the **Keep login active during system restart** check box to remember the user's password if the system restarts before the inactivity logout period has elapsed.
4. Tap  to save the changes and return to the *Settings* window.

### 4.6.3.2 Running diagnostics

Tap the **Diagnostics** button to check the network connection and speed.

**To run system diagnostics:**

1. Tap the **Diagnostics** button.

The network connection and speed are checked.

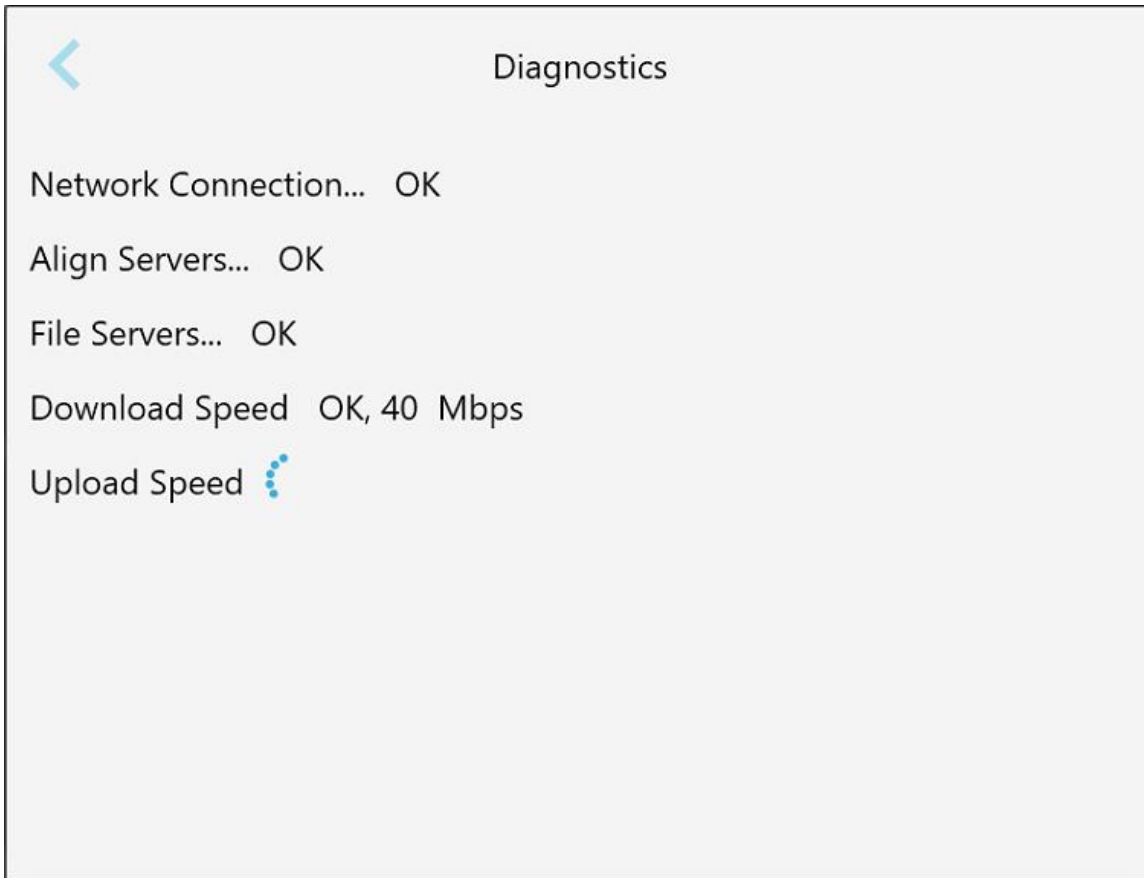



Figure 71: Diagnostics window

2. Tap  to return to the *Settings* window.

### 4.6.3.3 Licenses

Tap the **Licenses** button to view a list of third-party software components installed on the scanner and then tap  to return to the *Settings* window.

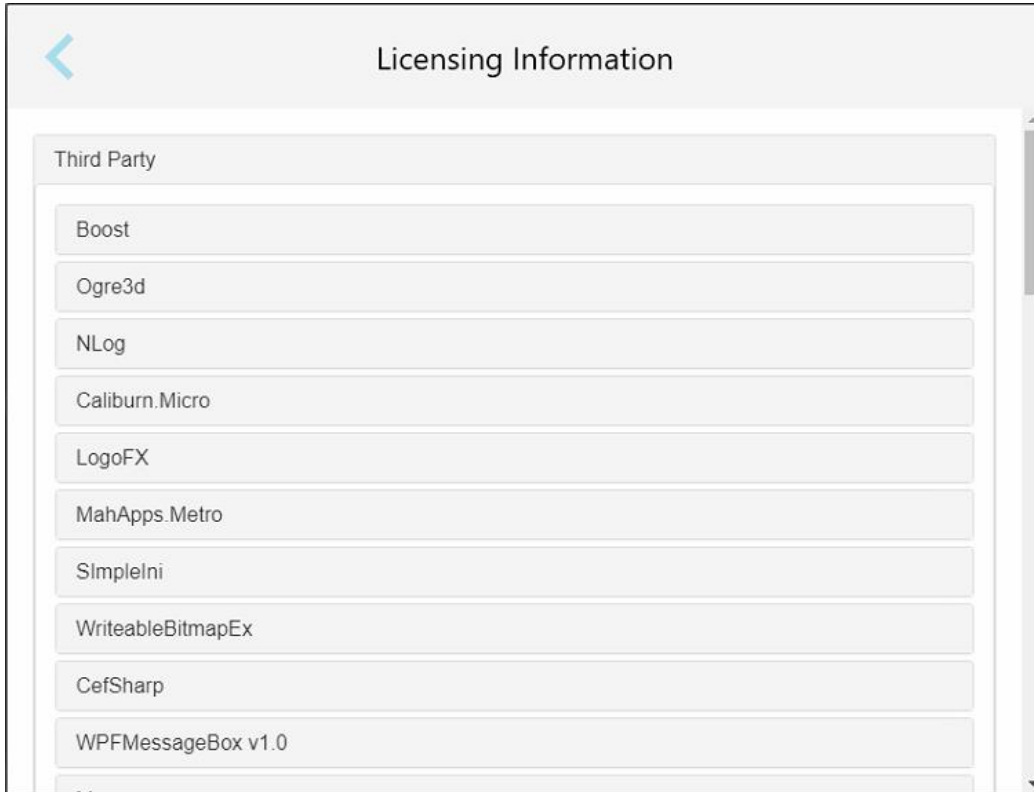

Figure 72: Licensing Information window

#### 4.6.3.4 System information

Tap the **System Information** button to view details about the software versions currently installed and the hardware serial numbers and ID, and then tap  to return to the *Settings* window.



Figure 73: System Information window – iTero Element 5D Plus

#### 4.6.3.5 Sync configuration

Tap the **Sync Configuration** button to synchronize any new updates from the server, for example, new software options.

#### 4.6.3.6 Export settings

You can define how long exported files should be kept before being deleted. In addition, you can view the local network address of the exported files, in boldface letters (starting with “\”). This address is accessible from any computer within the local network.

**Note:** If required, you can export the files at any time from MyiTero.



**To edit the export settings:**

1. Tap the **Export Settings** button.
2. Select the number of days after which exported files should be deleted. By default, this is set at 30 days.

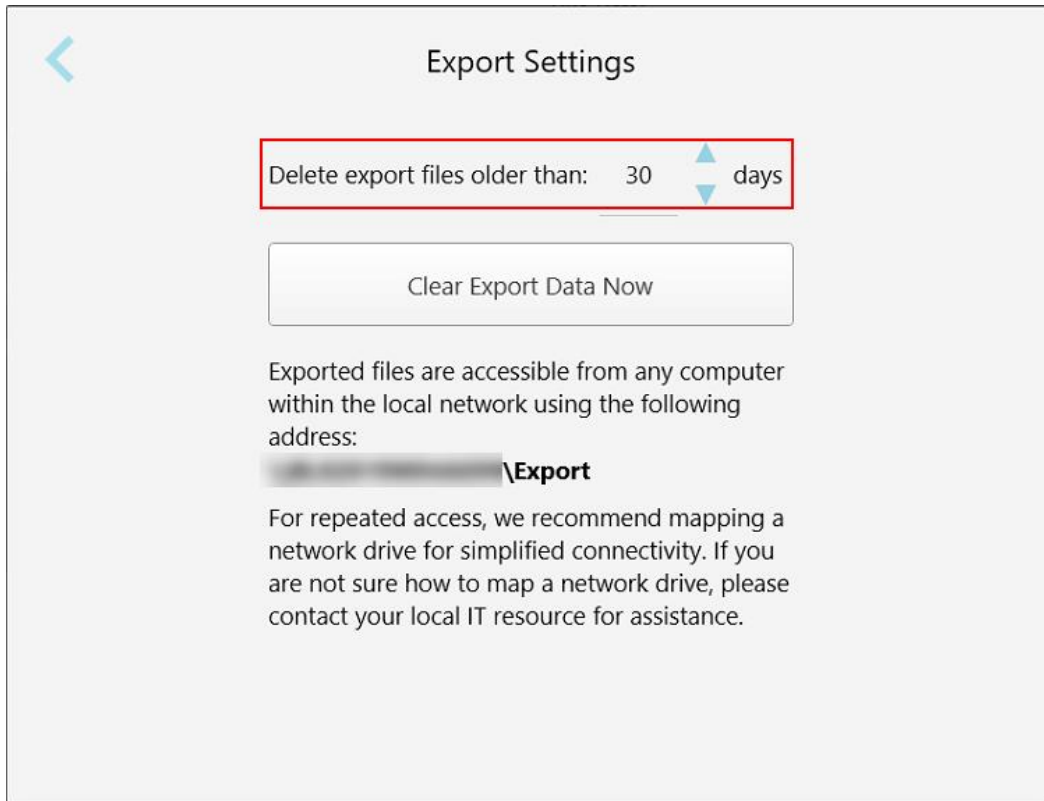



Figure 74: Export Settings window – deleting exported files

3. If required, tap **Clear Export Data Now** to delete the exported files immediately.
4. Tap  to return to the *Settings* window.

## 5 Starting a new scan

Before starting a new scan, you must:

- Check whether there are any particles on the wand. If so, repeat the cleaning and disinfection process, described in [Cleaning and disinfecting the wand](#).
- Apply a new wand sleeve to prevent cross-contamination, as described below.  
**Note:** If you notice any damage, do not use the sleeves and contact Customer Support.
- Fill in the Rx form in the *New Scan* window.
  - Enter the details of a new patient into your iTerо system, described in [Adding new patients](#), or search for an existing patient, described in [Searching for existing patients](#).
  - Enter the details of the procedure required, described in [Filling in the Rx](#).

### 5.1 Applying a wand sleeve

**To apply a wand sleeve:**

1. Gently remove the blue protective sleeve from the wand.
2. Gently slide a new sleeve onto the tip of the wand until it clicks into place.

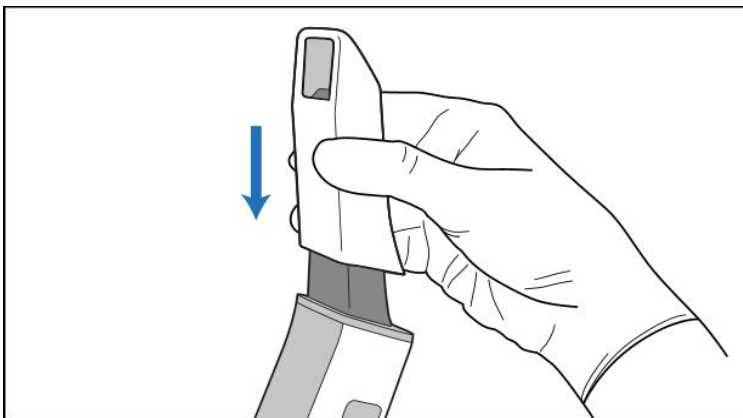
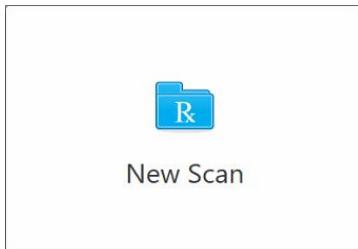

Figure 75: Gently slide the new sleeve into place

## 5.2 Starting the scanning process

On the home screen, tap the **New Scan** button to start the scanning process.



The *New Scan* window is displayed, as well as a toolbar that shows your progress throughout the scanning process.

A screenshot of the 'New Scan' application window. The title bar at the top left says 'New Scan'. A toolbar at the top center contains several icons: a blue folder with 'R', a lock, a magnifying glass, and an envelope, all enclosed in a red rectangular box. The main content area is divided into several sections: 'Doctor: Dr. Demo, Demo' and 'License: 12345' at the top; a 'Patient:' section with fields for 'First Name: \*', 'Last Name: \*', 'Date of Birth:', 'Gender: Male Female', and 'Chart Number:'; an 'Order:' section with 'Procedure \*' and 'Type' dropdowns, and 'Due Date:' and 'Send to' fields; 'Scan Options:' with 'NIRI Capture: ' and 'New Sleeve Attached: '; and a 'Notes' section with an 'Add Note' text input field.

Figure 76: New Scan window showing an empty Rx form and progress toolbar

If you have an iTerio Element 5D Plus Lite system, the *New Scan* window is displayed as follows:

**Figure 77: New Scan window – iTerio Element 5D Plus Lite**

The *New Scan* window shows the Rx form, which is made up of the following areas:

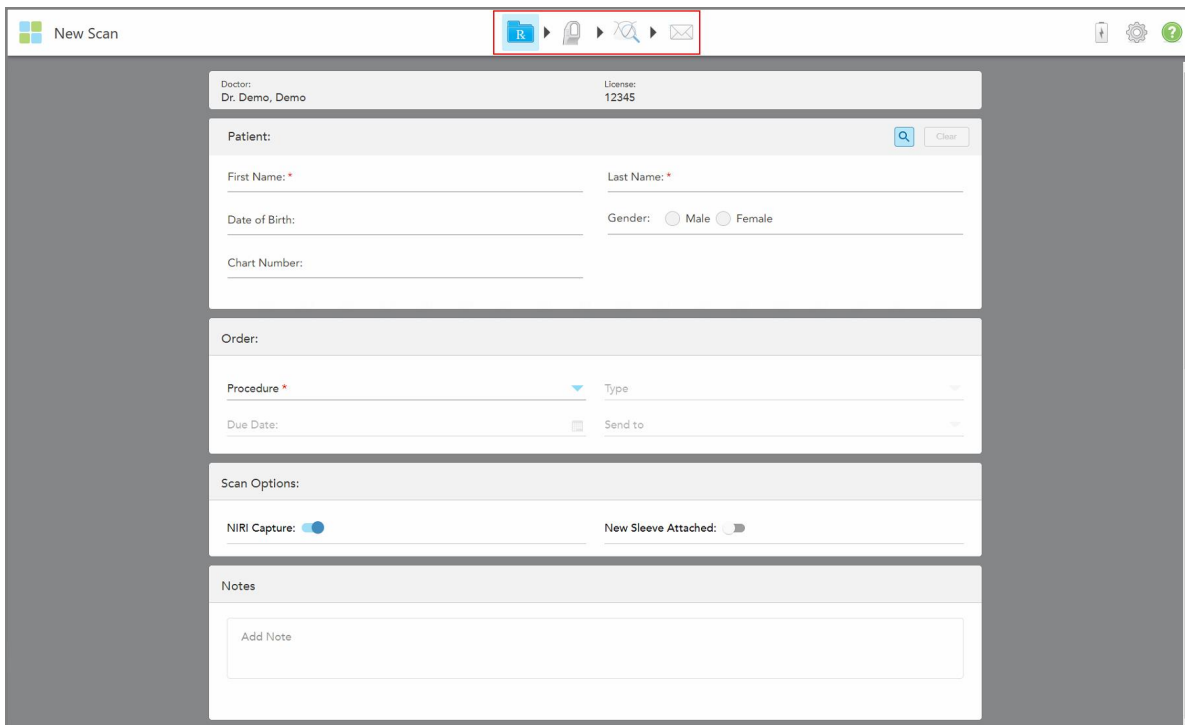
- **Doctor:** Displays the doctor's name and license number.
- **Patient:** Enables you to add a new patient to your iTerio system or search for an existing patient for whom to prescribe the treatment. Once the patient's details are displayed, you can edit them, or clear the details from the *New Scan* window. For more information, see [Patient management](#).
- **Order:** Enables you to define the details of the required procedure, for example, Invisalign.
- **Scan Options:** Enables you to turn on toggles regarding, for example, whether NIRI capture should be disabled, a new wand sleeve is attached, or the order should include a multi-bite scan.
- **Notes:** Enables you to enter any specific notes to the lab regarding the patient's treatment. For example, you can write special instructions for delivery or manufacturing. Tap anywhere outside the **Notes** area to add the note. Each note shows the author of the note, with a timestamp, and can be edited and deleted.

Additional areas and options may be displayed, depending on the procedure and procedure type selected in the **Order** area.

The scanning process requires the following steps, which are displayed on the toolbar:



[Filling in the Rx](#)



[Scanning the patient](#)



[Viewing the scan](#)



[Sending the scan](#)

Your current progress is highlighted on the toolbar.

### 5.3 Filling in the Rx

The first step in the scanning process is filling in the Rx (prescription) form. The *New Scan* window has a simple, intuitive workflow that fulfills all restorative and orthodontic application needs. It enables efficient collaboration with the labs and reduced back and forth by ensuring that all information required by the lab for production is included.

After entering the patient details, you can enter the details about the required procedure and procedure type, if relevant, select whether to include NIRI data in the scan, as well as enter notes for the lab regarding the scan. Fields marked with a red asterisk are mandatory before scanning.

**Note for Fixed Restorative and Denture/Removable procedures:** Some fields become mandatory only after scanning, before sending the scan.

**Note:** iTero NIRI technology is not supported by iTero Element 5D Plus Lite systems.

The screenshot shows the 'New Scan' window with the following fields and options:

- Doctor:** Dr. Demo, Demo; License: 12345
- Patient:** Search icon, Clear button, First Name: \*, Last Name: \*, Date of Birth:, Gender: Male Female, Chart Number:
- Order:** Procedure \*, Type, Due Date:, Send to
- Scan Options:** NIRI Capture: , New Sleeve Attached:
- Notes:** Add Note

Figure 78: New Scan window

#### To fill in the Rx:

1. In the **Patient** area, enter the first name and last name of the new patient.  
If required, enter the patient's date of birth, gender, and a unique chart number.

Or

Tap  to search for an existing patient, as described in [Searching for existing patients](#).

- In the **Order** area, from the **Procedure** drop-down list, select the required procedure.

**Note:** The list of procedures displayed depends on your iTero subscription package.

**Figure 79: Selecting the required procedure**

The following procedures are available by default, depending on whether you have a Restorative or Orthodontic subscription package:

- **Study Model/iRecord:** A simple scan with no additional modification, mainly used for studying purposes and referencing instead of storing the plaster model, as required by law. It can also be scanned as iCast, and is available on your Invisalign Doctor Site. For more information, see [Filling in the Rx for Study Model/iRecord procedures](#).
- **Invisalign:** The basic scan for all Invisalign treatments, including retainers. For more information, see [Filling in the Rx for Invisalign procedures](#).
- **Fixed Restorative:** A scan for all restorative treatments, for example, crowns and bridges. For more information, see [Filling in the Rx for Fixed Restorative procedures](#).
- **Implant Planning:** Enables ordering a surgical guide from the lab. For more information, see [Filling in the Rx for Implant Planning procedures](#).
- **Denture/Removable:** Enables comprehensive planning and fabrication of partial and full dentures. For more information, see [Filling in the Rx for Denture/Removable procedures](#).
- **Appliance:** Enables you to create a prescription for various dental appliances, for example, night guards and Apnea/Sleep appliances. For more information, see [Filling in the Rx for Appliance procedures](#).

The **Order** and **Scan Options** areas of the *New Scan* window are displayed according to the selected procedure.

- If relevant, from the **Type** drop-down list, select the procedure type required.  
**Note:** Procedure types are not relevant for Study Model/iRecord and Fixed Restorative procedures.
- If required, tap the calendar in the **Due Date** field and then select the date the case is due back from the lab.
- If required, from the **Send To** drop-down list, select the lab to which the scan should be sent, or your own chairside software. If you do not select anything, the scan will be sent to MyiTero only.
- Depending on the procedure selected, fill in the relevant additional details.

7. In the **Scan Options** area, turn on/off the following toggles, depending on the procedure selected, as required.
  - **NIRI Capture:** By default, all images are captured with NIRI data enabled. If required, you can disable NIRI data capture for the current scan by turning off the toggle.  
If required, you can disable NIRI data for all scans by default, as described in [Disabling NIRI data capture for all scans](#).  
**Note:** NIRI Capture is not relevant for iTerio Element 5D Plus Lite systems.
  - **Multi-Bite:** Turn on the **Multi-Bite** toggle if a multi-bite scan is required. This enables you to preserve the 2-bite relation based on your needs, and delivers comprehensive bite information to the lab for appliance fabrication.  
  
For Invisalign from Study Model/iRecord procedures, it is recommended that the first bite is scanned bilaterally. Only the first bite will be used in the ClinCheck software.
  - **New Sleeve Attached:** Turn on the **New Sleeve Attached** toggle to confirm that a new wand sleeve has been attached. For more information, see [Confirming a new wand sleeve between patients](#).
  - **Pre-Treatment Scan:** Turn on the **Pre-Treatment Scan** toggle if you would like to scan the patient before prepping the relevant tooth. In this case, the patient must be scanned twice – before and after the tooth has been prepped. The pre-treatment scan enables the lab to copy the original anatomy to the new restoration.
8. Depending on the procedure and procedure type selected, enter the relevant details in the additional areas that are displayed, for example, the **Tooth Diagram** area or the **Denture Details** area.
9. In the **Notes** area, if required, enter any specific notes to the lab regarding the patient's treatment. For example, special instructions for delivery or manufacturing. Tap anywhere outside the **Notes** area to add the note. Each note shows the author of the note, with a timestamp, and can be edited and deleted.
10. Tap  on the toolbar to move to Scan mode to scan the patient, as described in [Scanning the patient](#).

### 5.3.1 Filling in the Rx for Study Model/iRecord procedures

The **Study Model/iRecord** procedure requires a simple scan without any additional modification.

If you are an Invisalign doctor, all scans will be uploaded to the Invisalign Doctor Site and will be available in the ClinCheck software.

**To fill in the Rx for a Study Model/iRecord procedure:**

1. In the **Patient** area, enter a patient's details or search for an existing patient, as described in [Searching for existing patients](#).
2. In the **Order** area, select **Study Model/iRecord** from the **Procedure** drop-down list.



The *New Scan* window is displayed as follows:

Figure 80: Order and Scan Options areas – Study Model/iRecord procedure

3. If required, turn on the **Ortho Model/iCast** toggle to order a digital dental case.
4. Continue filling in the prescription from step 5, as described in [Filling in the Rx](#).

### 5.3.2 Filling in the Rx for Invisalign procedures

The Invisalign procedure is used to create prescriptions for all Invisalign orders, including retainers. The model must be scanned without any holes to ensure that the aligners are a perfect fit with the patient's teeth.

**To fill in the Rx for an Invisalign procedure:**

1. In the **Patient** area, enter a patient's details or search for an existing patient, as described in [Searching for existing patients](#).
2. In the **Order** area, select **Invisalign** from the **Procedure** drop-down list.

The *New Scan* window is displayed as follows:

Figure 81: Order area – Invisalign procedure

3. From the **Type** drop-down list, select the type of Invisalign procedure required, depending on your iTerо subscription package:
  - Invisalign Aligners – Invisalign Outcome Simulator Pro is available only for **Invisalign Aligners** procedure types. For more information on Invisalign Outcome Simulator Pro, see [Invisalign Outcome Simulator Pro](#).
  - Invisalign First Aligners
  - Invisalign First Palatal Expander
 

**Note:** Excess soft tissue will not be removed automatically from around the edges of the model during scanning. If required, you can enable automatic cleanup by pressing on the screen and then tapping the Auto Cleanup tool. For more information, see [Disabling auto-cleanup](#).
  - Vivera Retainer – maintains the position of the teeth after treatment. If brackets are still present, they will be removed by the iTerо software. The Vivera retainers will be provided at the debonding appointment.
  - Invisalign Retainer
4. For Invisalign Aligners, First Aligners, and First Palatal Expanders, you can select the **Treatment Stage**:
  - Initial Record – for the first Invisalign treatment scan. By default, the Current Aligner # is set to 0.
  - Progress Record – for multiple scans during the ongoing treatment. In addition, enter the patient's current Aligner number in the **Current Aligner #** field.
  - Final Record – for the scan done when treatment is completed. In addition, enter the patient's current Aligner number in the **Current Aligner #** field.

5. Continue filling in the prescription from step 8, as described in [Filling in the Rx](#).

For more information, refer to the Invisalign documentation.

### 5.3.3 Filling in the Rx for Fixed Restorative procedures

The Fixed Restorative procedure covers a range of restorations, including crowns, bridges, veneers, inlays, onlays, and implant-based restoration. When selecting fixed restorative procedures, you need to select the tooth that needs to be restored, the type of restoration required, as well as the material, shade, etc. of the restoration.

**Note:** Some fields are not mandatory before scanning the patient but must be filled in before you can send the scan.

#### To fill in the Rx for a Fixed Restorative procedure:

1. In the **Patient** area, enter a patient's details or search for an existing patient, as described in [Searching for existing patients](#).
2. In the **Order** area, select **Fixed Restorative** from the **Procedure** drop-down list.

The *New Scan* window expands and a **Tooth Diagram** area showing the tooth numbers and illustrations is displayed in the window.

Figure 82: Scan Options and Tooth Diagram areas – Fixed Restorative procedure

3. If required, tap the calendar in the **Due Date** field and then select the date the restoration is due from the lab.
4. If required, from the **Send To** drop-down list, select the lab to which the scan should be sent, or your own chairside software.
5. In the **Scan Options** area, turn on/off the following toggles, as required.
  - **NIRI Capture:** By default, all images are captured with NIRI data enabled. If required, you can disable NIRI data capture for the current scan by turning off the toggle.  
If required, you can disable NIRI data for all scans by default, as described in [Disabling NIRI data capture for all scans](#).

**Note:** NIRI Capture is not relevant for iTerо Element 5D Plus Lite systems.

- **New Sleeve Attached:** Turn on the **New Sleeve Attached** toggle to confirm that a new wand sleeve has been attached. For more information, see [Confirming a new wand sleeve between patients](#).
- **Pre-Treatment Scan:** Turn on the **Pre-Treatment Scan** toggle if you would like to scan the patient before prepping the relevant tooth. In this case, the patient must be scanned twice – before and after the tooth has been prepped. The pre-treatment scan enables the lab to copy the original anatomy to the new restoration.

6. In the **Tooth Diagram** area, tap the tooth to be restored.

A list of available options for the selected tooth is displayed.

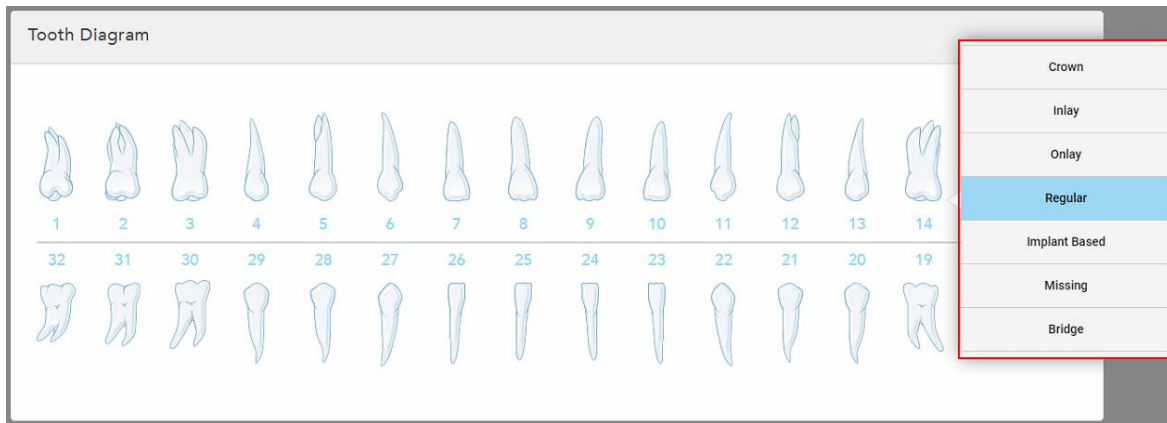

Figure 83: List of fixed restorative treatment options

7. Select the required treatment option.

Depending on the fixed restorative treatment option selected, a treatment window is displayed.

**Note:** Treatment options are mandatory before sending the scan, but can be filled in after scanning.

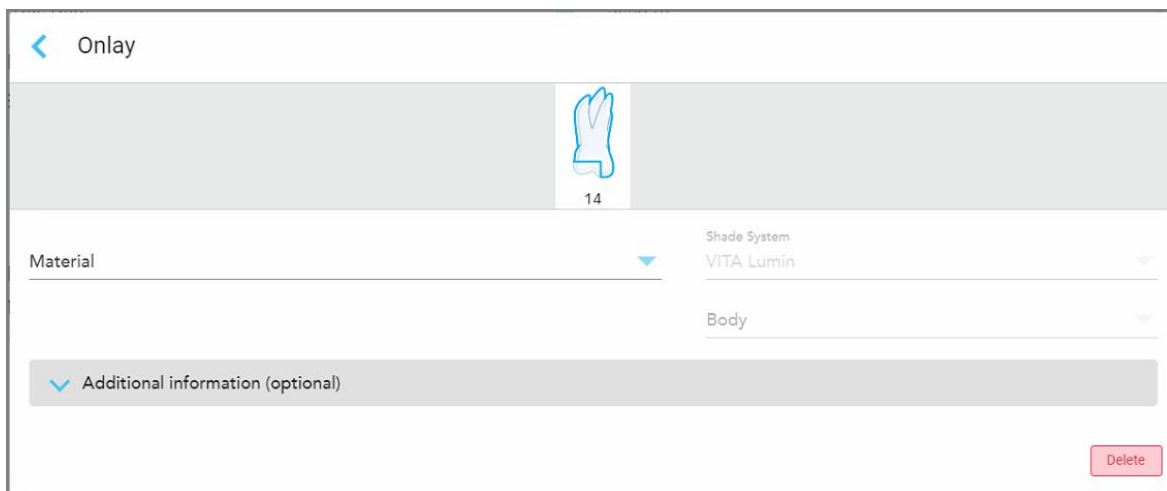



Figure 84: Treatment settings window – Onlay restoration

8. Select the relevant treatment settings for each tooth, according to the treatment option selected:
  - **Crown**, described in [Crown, Veneer, Laminates, Inlay, and Onlay restorations](#)
  - **Inlay/Onlay** (relevant for molars and premolars only), described in [Crown, Veneer, Laminates, Inlay, and Onlay restorations](#)
  - **Implant Based**, described in [Implant Based restorations](#)
  - **Veneers/Laminates** (relevant for the incisors and premolars only), described in [Crown, Veneer, Laminates, Inlay, and Onlay restorations](#)
  - **Bridge**, described in [Bridge restorations](#)

**Note:** If an implant abutment is already in the mouth, select Crown from the drop-down list.

In addition:

- If a tooth is missing, tap **Missing**
- To delete a restoration plan, tap **Regular**

9. Tap  to save the selection and return to the *New Scan* window.

The selected teeth are highlighted and the selected treatment options are displayed in the **Treatment Information** area below the **Tooth Diagram** area.

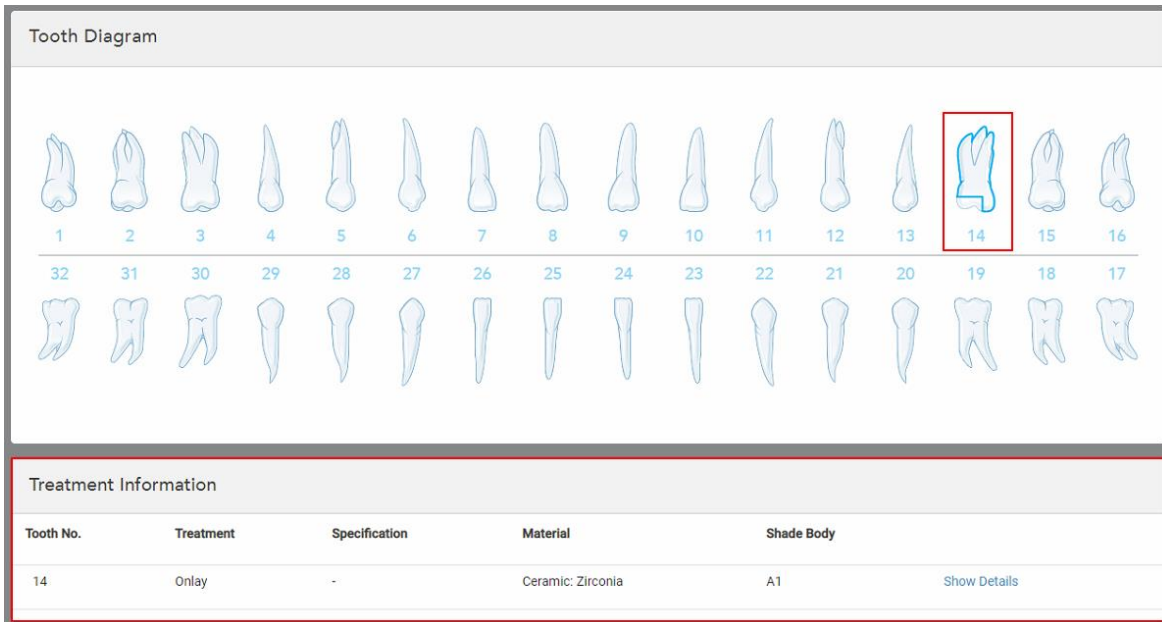

Figure 85: Selected tooth and Treatment Information area – Onlay restoration

You can change the selected treatment options at any time before sending the scan by tapping **Show Details** and editing the settings of a specific tooth.

10. In the **Notes** area, if required, enter any specific notes to the lab regarding the patient’s treatment. For example, special instructions for delivery or manufacturing. Tap anywhere outside the **Notes** area to add the note. Each note shows the author of the note, with a timestamp, and can be edited and deleted.

### 5.3.3.1 Crown, Veneer, Laminates, Inlay, and Onlay restorations

Follow the procedure below to complete filling in the Rx for Crown, Veneer, Laminates, Inlay, and Onlay restorations.

**Note:** If more than one tooth requires restoration, you can copy the treatment settings to each tooth requiring the same restoration type.

**To fill in the Rx for a Crown, Veneer, Laminates, Inlay, or Onlay restoration:**

1. In the **Tooth Diagram**, tap the tooth that needs restoration and then select the required treatment option from the drop-down list, for example, **Crown**.

The **Crown** treatment settings window is displayed.

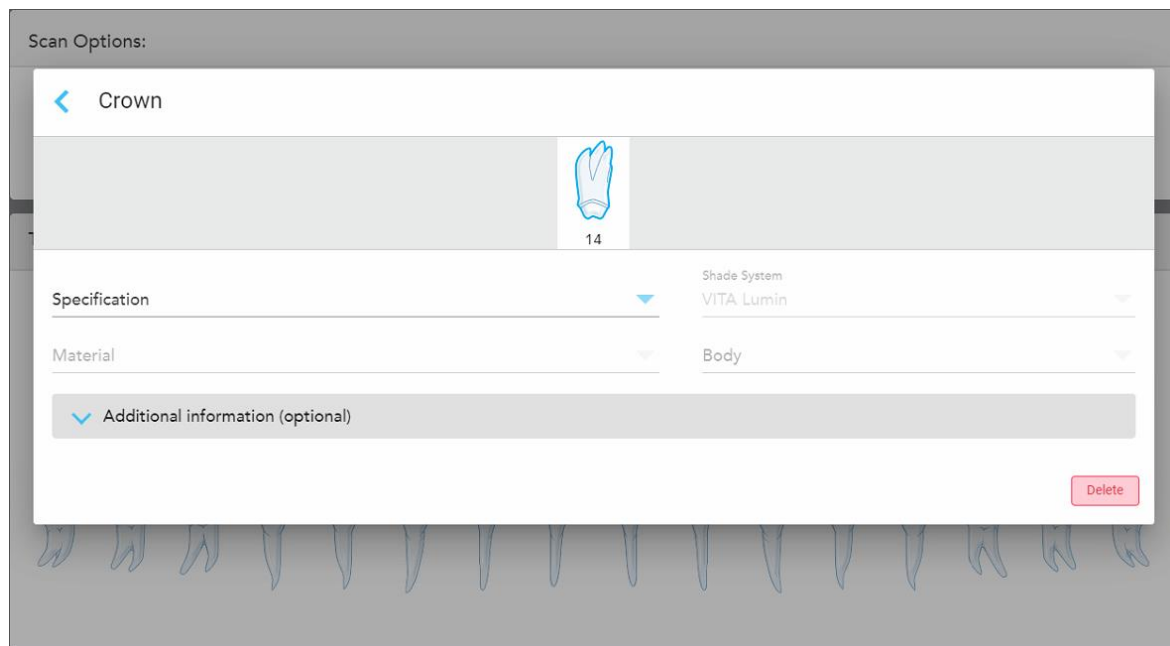
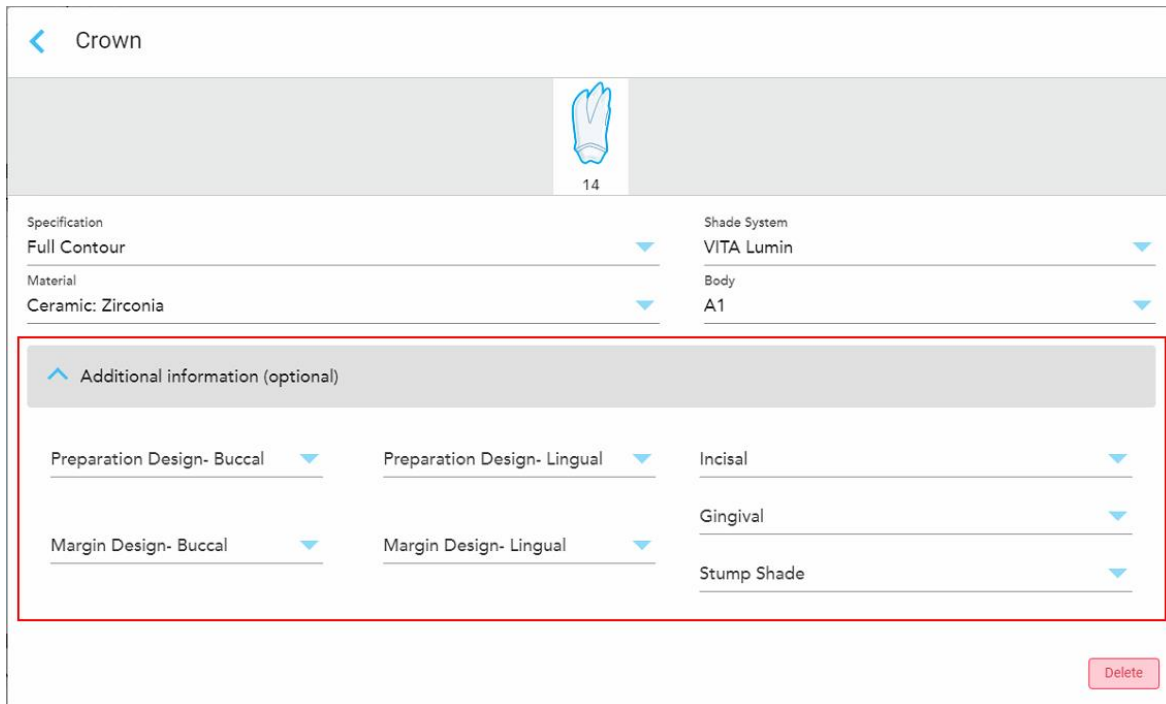

Figure 86: Treatment settings window – Crown restoration

2. Select the following mandatory settings from the relevant drop-down lists:
  - a. **Specification:** The type of crown to be fabricated.
 

**Note:** Relevant for Crown treatments only. Once you have selected the type of crown required, you can select the rest of the options.
  - b. **Material:** The material from which the restoration should be fabricated, depending on the specification selected. This can be copied to all teeth included in the restoration.
  - c. **Shade System:** The system used for choosing the shade of the restoration.
  - d. **Body:** The shade for the body area of the restoration.

3. If required, tap  to expand the **Additional information** area to display additional optional settings:



**Figure 87: Additional information area – Crown restoration**

- **Preparation Design (Buccal and Lingual):** The shape of the finishing line (margin line) created by the user during the preparation. You can choose this for both the buccal and the lingual.
  - **Margin Design (Buccal and Lingual):** The type of ceramic-metal border relationship required for the selected metal-based crown. You must choose this for both the buccal and the lingual. This is relevant only for metal dental work.
  - **Incisal:** The shade for the incisal area of the restoration.
  - **Gingival:** The shade for the gingival area of the restoration.
  - **Stump Shade:** The shade of the prepped tooth.
4. Tap  to save the selection and return to the *New Scan* window.



The selected treatment options are displayed in the **Treatment Information** area below the **Tooth Diagram** area. You can change the selected treatment options at any time before sending the scan by tapping **Show Details** and editing the settings of a specific tooth.

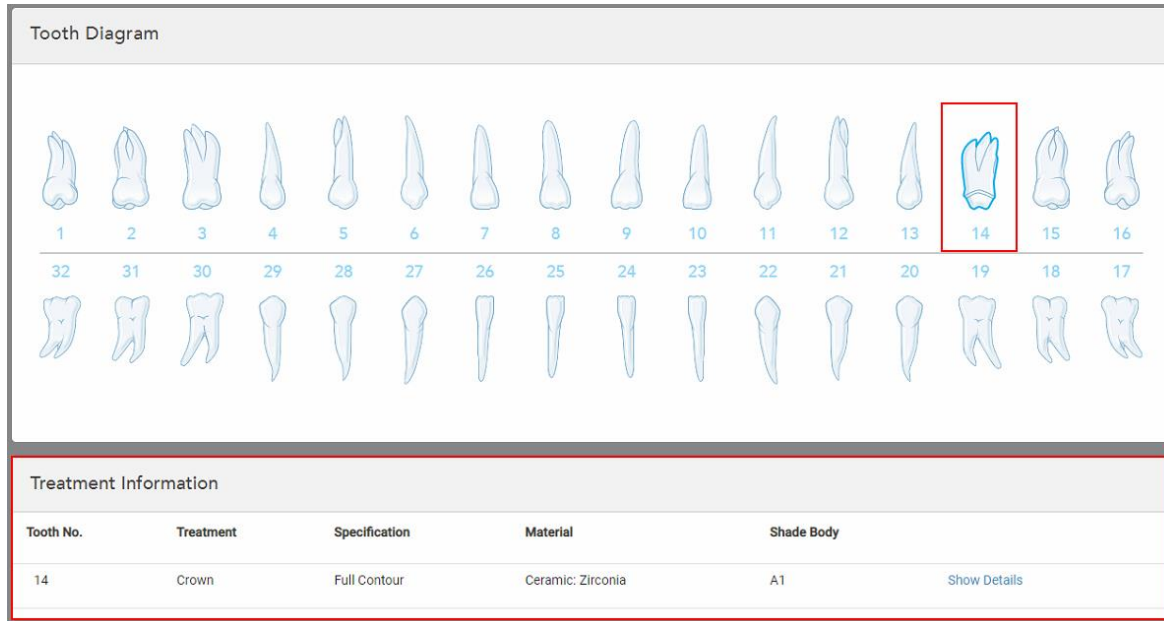

Figure 88: Selected tooth and Treatment Information area – Crown restoration

- Repeat this procedure for each tooth requiring treatment.

If a tooth requires the same treatment as a tooth for which you have already defined the treatment settings, you can copy the settings by tapping the tooth and then selecting **Copy From Tooth #** from the drop-down list.

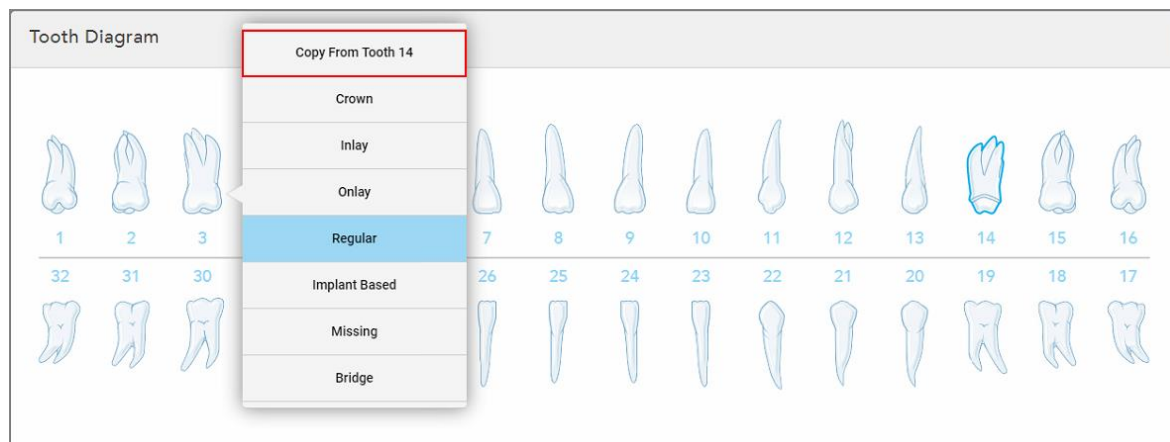

Figure 89: Copy restoration settings from a tooth requiring the same treatment type

The treatment settings are copied to the tooth and are displayed in the **Treatment Information** area below the **Tooth Diagram** area.

- Complete filling in the details in the *New Scan* window, as described in [Filling in the Rx for Fixed Restorative procedures](#).

### 5.3.3.2 Implant Based restorations

Implant Based restorations are created as part of Fixed Restorative procedures, described in [Filling in the Rx for Fixed Restorative procedures](#).

After starting to fill in the Rx for Fixed Restorative procedures, continue with the procedure below for Implant Based restorations.

**Note:** If an implant abutment already exists, you should select the **Crown** restoration, as described in [Crown, Veneer, Laminates, Inlay, and Onlay restorations](#).

**To fill in the Rx for an Implant Based restoration:**

1. In the **Tooth Diagram**, tap the tooth that needs an implant abutment and then select **Implant Based** from the drop-down list.

The **Implant Based** treatment settings window is displayed.

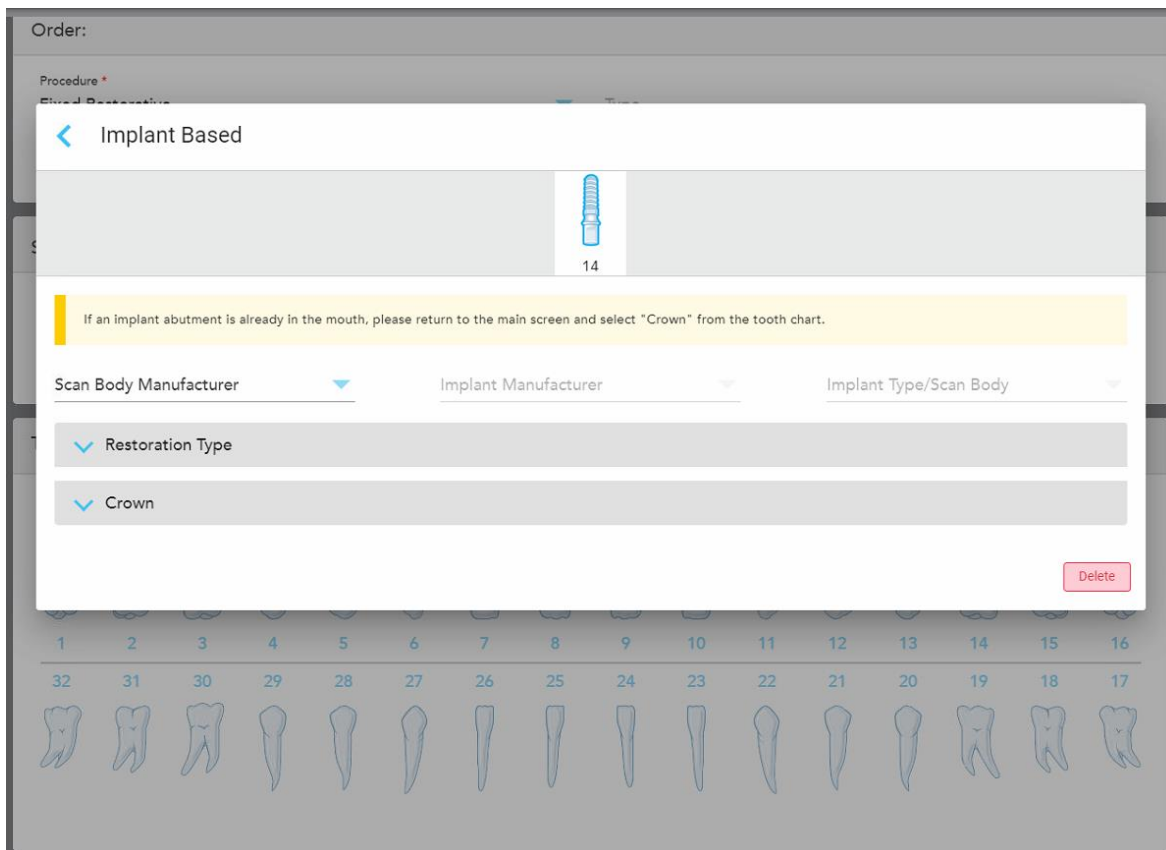

Figure 90: Treatment settings window – Implant Based restoration

2. Select the scan body manufacturer, implant manufacturer, and then the implant type/scan body from the relevant drop-down lists.



- Tap  to expand the **Restoration Type** area and then select the restoration type, abutment type, and abutment material from the relevant drop-down lists. If a titanium base is in place, turn on the **Ti-Base** toggle. You can select these options after scanning, but they must be selected before sending the scan.



Figure 91: Expanded Restoration Type area

- Tap  to expand the **Crown** area and then select the required settings from the relevant drop-down lists, as described in [Crown, Veneer, Laminates, Inlay, and Onlay restorations](#). You can select these options after scanning, but they must be selected before sending the scan.

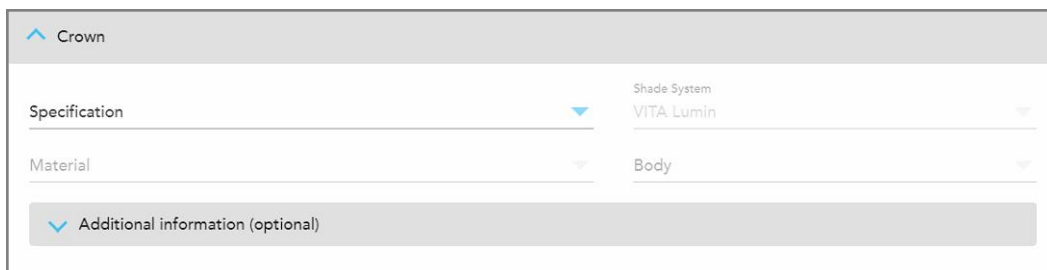



Figure 92: Expanded Crown area

- Tap  to save the selection and return to the *New Scan* window.
- Complete filling in the details in the *New Scan* window, as described in [Filling in the Rx for Fixed Restorative procedures](#).

### 5.3.3.3 Bridge restorations

Follow the procedure below to complete filling in the Rx for Bridge restorations.

#### To fill in the Rx for a Bridge restoration:

- In the **Tooth Diagram** area, tap one of the teeth to be included in the bridge and then select **Bridge** from the drop-down list.

The **Bridge** treatment settings window is displayed.

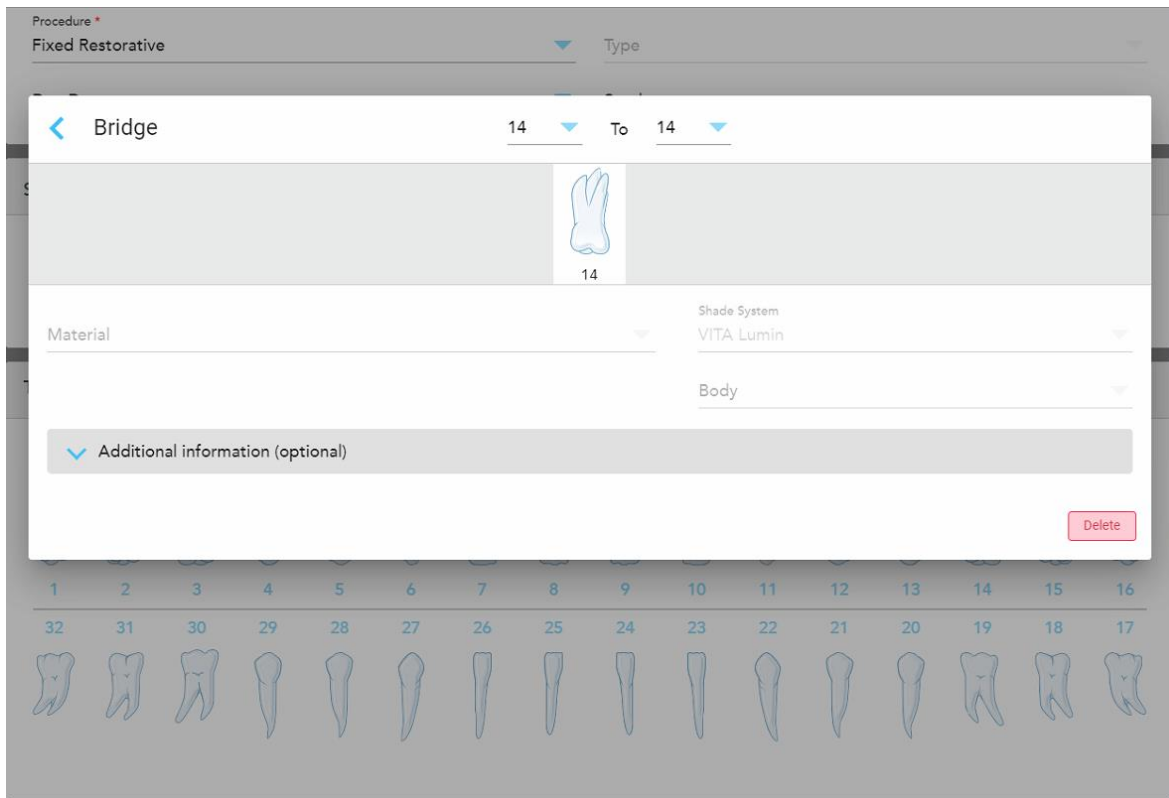

Figure 93: Treatment settings window – Bridge restoration

2. Select the span of the teeth to be included in the bridge from the arrows at the top of the window.

The teeth to be included in the bridge are displayed.

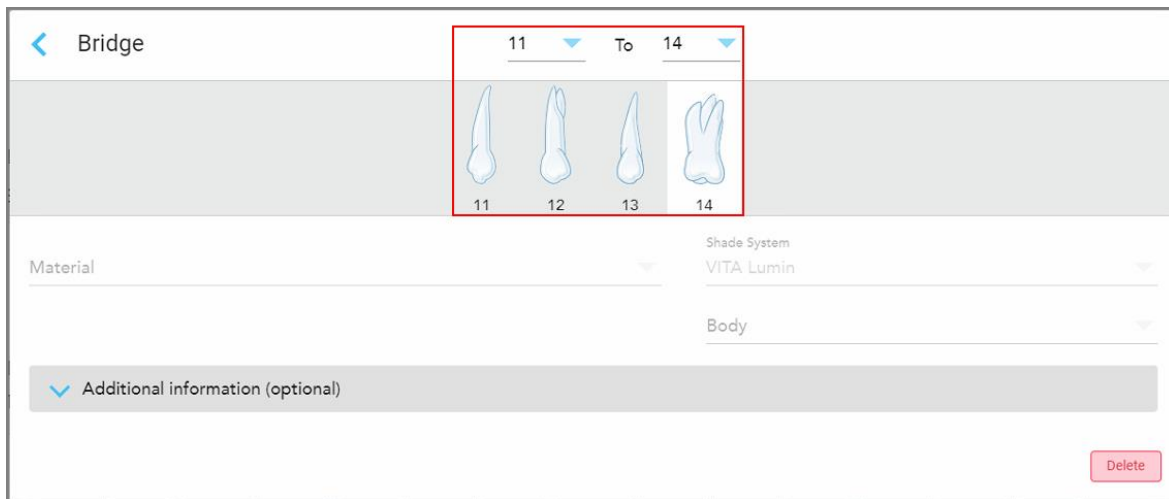

Figure 94: Bridge range and teeth to be included

3. Tap each tooth in the tooth range and then select the in-bridge treatment option from the list:

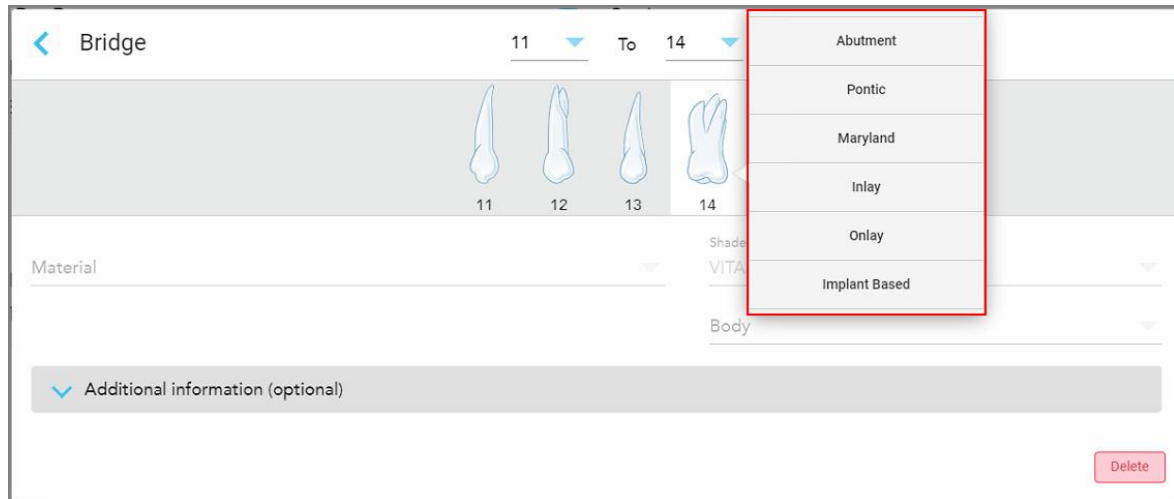

Figure 95: List of in-bridge treatment options

4. For all options besides **Implant Based**:

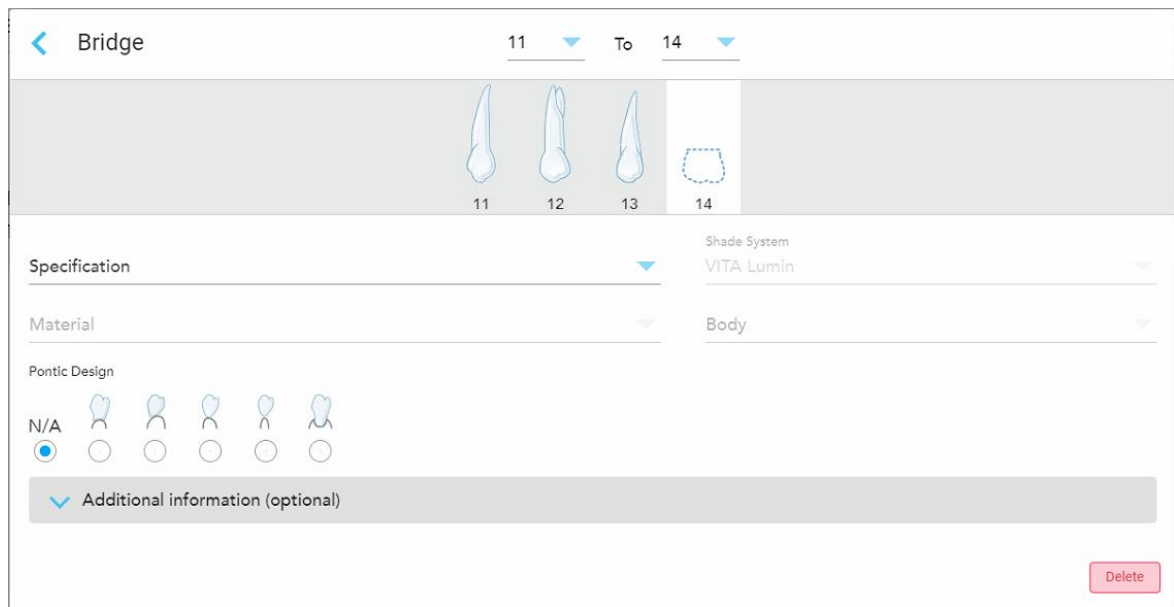
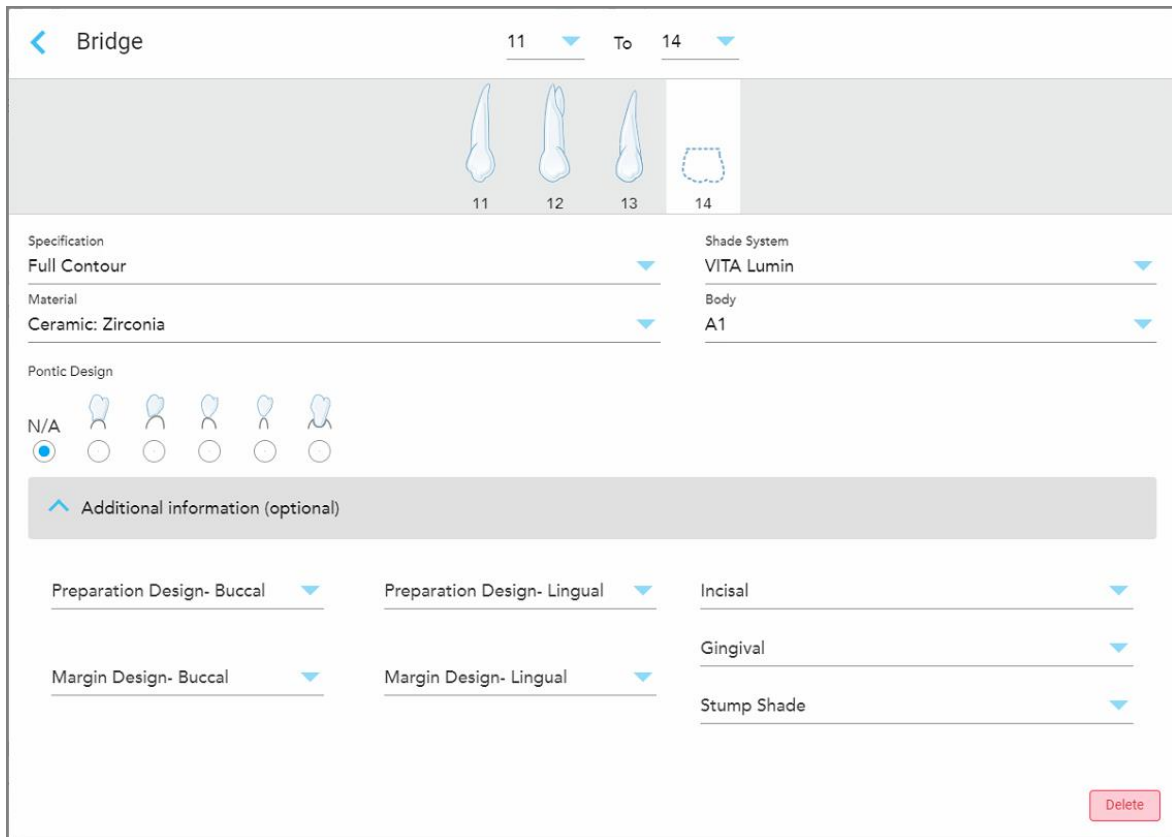

Figure 96: Bridge. restoration – Pontic settings

- a. **Specification:** The type of restoration to be fabricated.
- b. **Material:** The material from which the restoration should be fabricated. This is automatically copied to each tooth in the restoration.
- c. **Shade System:** The system used for choosing the shade of the restoration.
- d. **Body:** The shade for the body area of the restoration.
- e. **Pontic Design:** Relevant only if **Pontic** was selected as the in-bridge treatment option.

5. If required, tap  to expand the **Additional information** area to display other optional settings:



**Figure 97: Additional information area – Bridge restoration**

- **Preparation Design (Buccal and Lingual):** The shape of the finishing line (margin line) created by the user during the preparation. You can choose this for both the buccal and the lingual.
- **Margin Design (Buccal and Lingual):** The type of ceramic-metal border relationship required for the selected metal-based crown. You must choose this for both the buccal and the lingual. This is relevant only for metal dental work.
- **Incisal:** The shade for the incisal area of the restoration.
- **Gingival:** The shade for the gingival area of the restoration.
- **Stump Shade:** The shade of the prepped tooth.

6. If you selected **Implant Based**, the Bridge treatment options are displayed as follows:

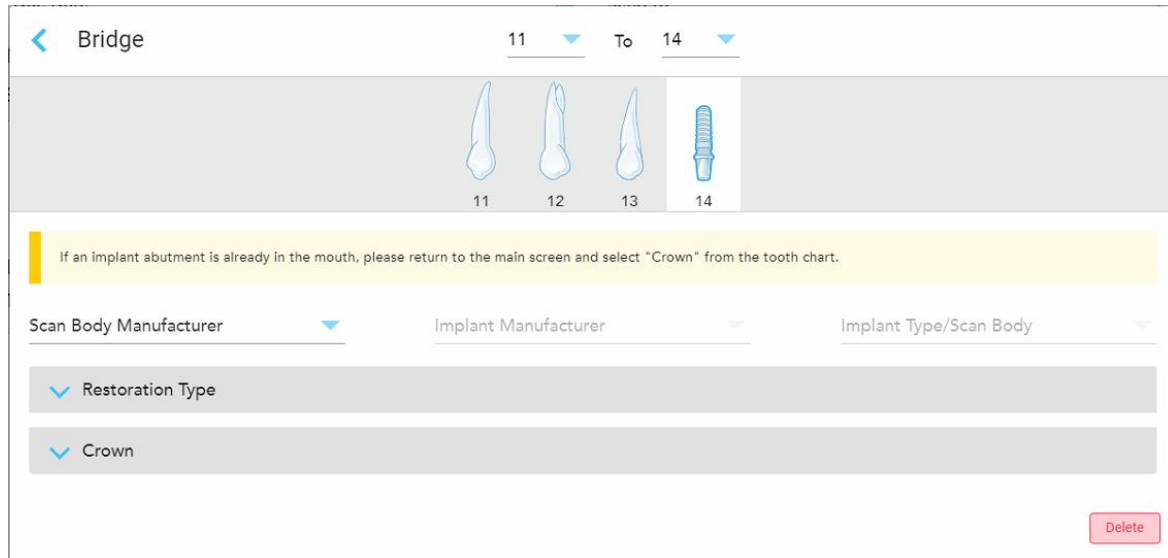



Figure 98: Bridge treatment options – Implant Based

- Select the scan body manufacturer, implant manufacturer, and implant type/scan body from the drop-down lists.
- Tap  to expand the **Restoration Type** area and then select the restoration type, abutment type, and abutment material from the relevant drop-down lists. If a titanium base is in place, turn on the **Ti-Base** toggle.

You can select these options after scanning, but they must be selected before sending the scan.



Figure 99: Expanded Restoration Type area

- Tap  to expand the **Crown** area and then select the required settings from the relevant drop-down lists, as described in [Crown, Veneer, Laminates, Inlay, and Onlay restorations](#).

You can select these options after scanning, but they must be selected before sending the scan.

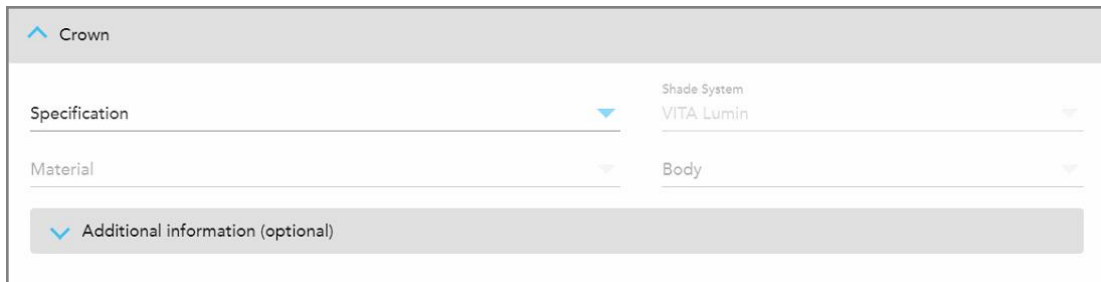



Figure 100: Expanded Crown area

7. Tap  to save the selection and return to the *New Scan* window.
8. Complete filling in the details in the *New Scan* window, as described in [Filling in the Rx for Fixed Restorative procedures](#).

### 5.3.4 Filling in the Rx for Implant Planning procedures

The **Implant Planning** procedure enables efficient communication with the labs regarding surgical-guide prescription requirements. If required, orders can also be sent to your chairside software and seamlessly imported directly into exoplan™ or other chairside planning software.

**To fill in the Rx for an Implant Planning procedure:**

1. In the **Patient** area, enter a patient's details or search for an existing patient, as described in [Searching for existing patients](#).
2. In the **Order** area, select **Implant Planning** from the **Procedure** drop-down list.
3. From the **Type** drop-down list, select the type of surgical guide required:

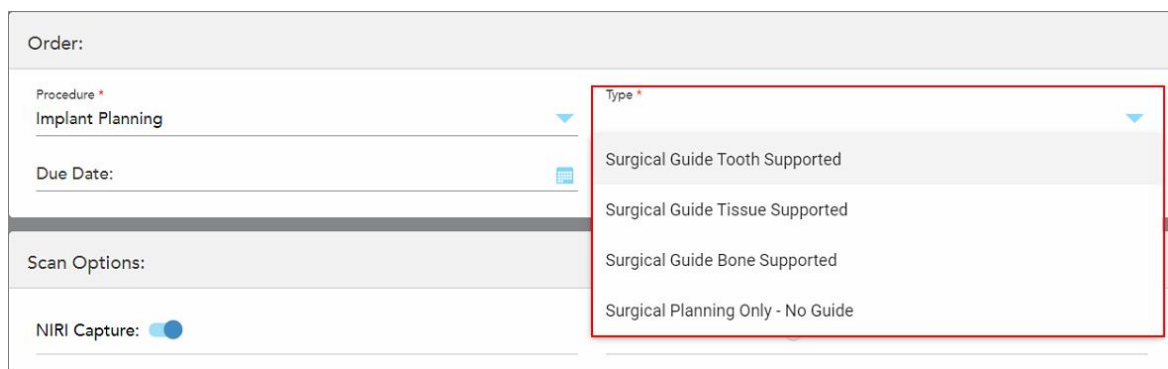

Figure 101: Implant Planning procedure types



The *New Scan* window expands to show the **Tooth Diagram** area:

The screenshot shows the 'New Scan' window with the following details:

- Doctor:** Dr. Demo, Demo | **License:** 12345
- Patient:**
  - First Name: Patient1 | Last Name: Demo
  - Date of Birth: | Gender:  Male  Female
  - Chart Number: |
- Order:**
  - Procedure: Implant Planning | Type: Surgical Guide Tooth Supported
  - Due Date: | Send to: |
- Scan Options:**
  - NIRI Capture:  | New Sleeve Attached:
- Tooth Diagram:** A grid of 32 tooth icons, numbered 1 through 32, arranged in two rows of 16. The top row shows teeth 1-16 and the bottom row shows teeth 32-17.
- Notes:** Add Note

**Figure 102: Implant Planning procedure – Tooth Diagram for Surgical Guide Tooth Supported**

4. If required, tap the calendar in the **Due Date** field and then select the date the plan is due.
5. If required, from the **Send To** drop-down list, select the lab to which the scan should be sent, or your own chairside software.
6. In the **Scan Options** area, turn on/off the following toggles, as required.
  - **NIRI Capture:** By default, all images are captured with NIRI data enabled. If required, you can disable NIRI data capture for the current scan by turning off the toggle. If required, you can disable NIRI data for all scans by default, as described in [Disabling NIRI data capture for all scans](#).
  - Note:** NIRI Capture is not relevant for iTero Element 5D Plus Lite systems.
  - **New Sleeve Attached:** Turn on the **New Sleeve Attached** toggle to confirm that a new wand sleeve has been attached. For more information, see [Confirming a new wand sleeve between patients](#).

- In the **Tooth Diagram** area, select each tooth to be implanted and select **Implant Position** from the drop-down list.

If you selected **Surgical Guide Tooth Supported** as the procedure type, you can also select each supporting tooth and then select **Supporting Tooth** from the drop-down list. Supporting teeth are displayed in the **Tooth Diagram** area with a line under them.

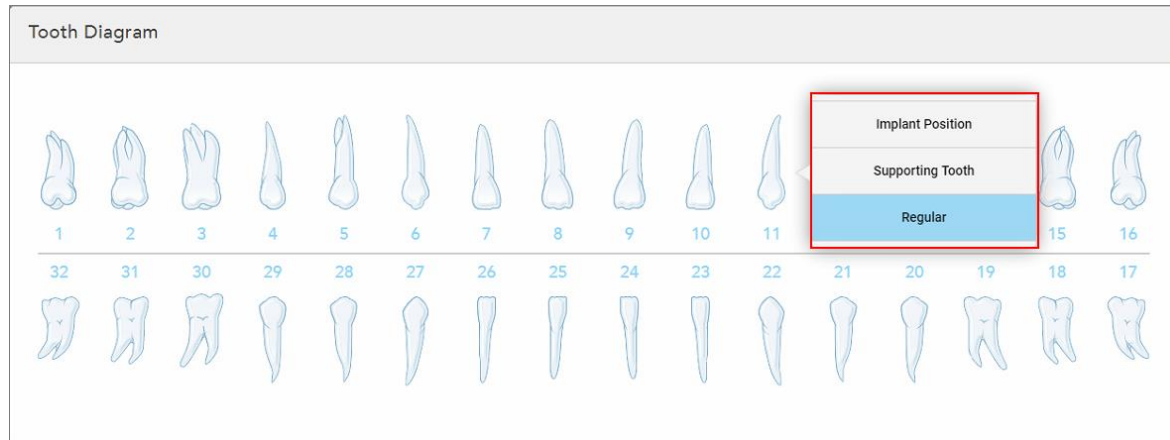

Figure 103: Defining the teeth that need to be implanted

For each tooth selected to be implanted, the *Implant Position* window is displayed.

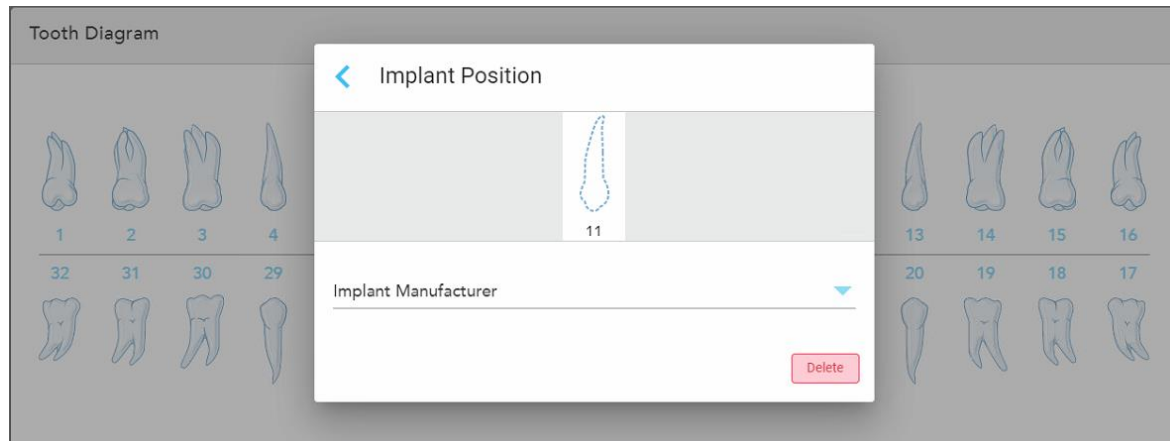



Figure 104: Implant Position window

- Select the implant manufacturer from the drop-down list.
- Tap  to save your changes and return to the *New Scan* window.

The teeth to be implanted and the supporting teeth, if relevant, are displayed in the **Tooth Diagram** area. Supporting teeth have a line under them and the teeth to be implanted are shown with a dotted line.

The details of each relevant tooth are displayed in the *Treatment Information* area below the **Tooth Diagram** area.

**Tooth Diagram**

**Treatment Information**

Tooth No.	Treatment	Specification	Material	Shade Body
8	Supporting Tooth	-	-	- <a href="#">Show Details</a>
9	Implant Position	-	-	- <a href="#">Show Details</a>
10	Implant Position	-	-	- <a href="#">Show Details</a>
11	Implant Position	-	-	- <a href="#">Show Details</a>
12	Supporting Tooth	-	-	- <a href="#">Show Details</a>

**Figure 105:** Supporting teeth and teeth to be implanted displayed in the Tooth Diagram and Treatment Information areas

- In the **Notes** area, if required, enter any specific notes to the lab regarding the patient's treatment. For example, special instructions for delivery or manufacturing. Tap anywhere outside the **Notes** area to add the note. Each note shows the author of the note, with a timestamp, and can be edited and deleted.

### 5.3.5 Filling in the Rx for Denture/Removable procedures

The Denture/Removable procedure enables comprehensive planning and fabrication of partial and full dentures.

**Note:** Some fields are not mandatory before scanning the patient but must be filled in before you can send the scan.

**To fill in the Rx for a Denture/Removable procedure:**

- In the **Patient** area, enter a patient's details or search for an existing patient, as described in [Searching for existing patients](#).
- In the **Order** area, select **Denture/Removable** from the **Procedure** drop-down list.

- From the **Type** drop-down list, select the type of denture required.

The screenshot shows a software interface for configuring a denture procedure. At the top, there is an 'Order:' section with a 'Procedure' dropdown set to 'Denture/Removable' and a 'Due Date' field with a calendar icon. Below this is the 'Denture Details:' section. The 'Type' dropdown menu is open, showing four options: 'Partial Denture/Framework', 'Immediate Denture', 'Full Denture Tissue Based', and 'Full Denture Implant Based'. Other fields in the 'Denture Details' section include 'Stage', 'Mould', 'Teeth Shade', and 'Gingival', each with a dropdown arrow. At the bottom, there are two toggle switches for 'Upper Denture' and 'Lower Denture'.

Figure 106: Denture/Removable procedure types

- If required, tap the calendar in the **Due Date** field and then select the date the denture is due from the lab.
- If required, from the **Send To** drop-down list, select the lab to which the scan should be sent, or your own chairside software.
- If required, in the **Denture Details** area, select the denture stage (relevant only for full tissue-based and full implant-based procedure types), mould, and shade system, including the teeth shade and the gingiva shade from the relevant drop-down lists.

**Upper/Lower Denture:** The relevant arch toggle turns on automatically according to the tooth indications in the **Tooth Diagram** area.

- In the **Scan Options** area, turn on/off the following toggles, as required.
  - NIRI Capture:** By default, all images are captured with NIRI data enabled. If required, you can disable NIRI data capture for the current scan by turning off the toggle. If required, you can disable NIRI data for all scans by default, as described in [Disabling NIRI data capture for all scans](#).

**Note:** NIRI Capture is not relevant for iTerio Element 5D Plus Lite systems.

- **Denture Copy Scan:** Turn on the **Denture Copy Scan** toggle to include a scan of a previous or temporary denture. When you move to Scan mode, tap **1** to scan the previous dentures, and then tap **2** to scan the patient.

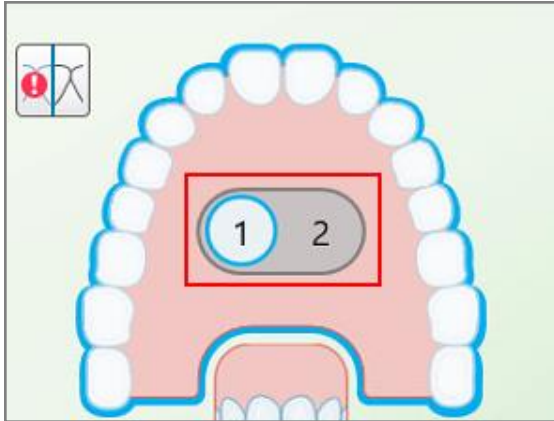

Figure 107: Scanning option for scanning both the dentures and the patient

- **New Sleeve Attached:** Turn on the **New Sleeve Attached** toggle to confirm that a new wand sleeve has been attached. For more information, see [Confirming a new wand sleeve between patients](#).
8. In the **Tooth Diagram** area, define the teeth to be included in the denture according to the procedure type selected. This area is not relevant for Full Denture Tissue Based procedure types.

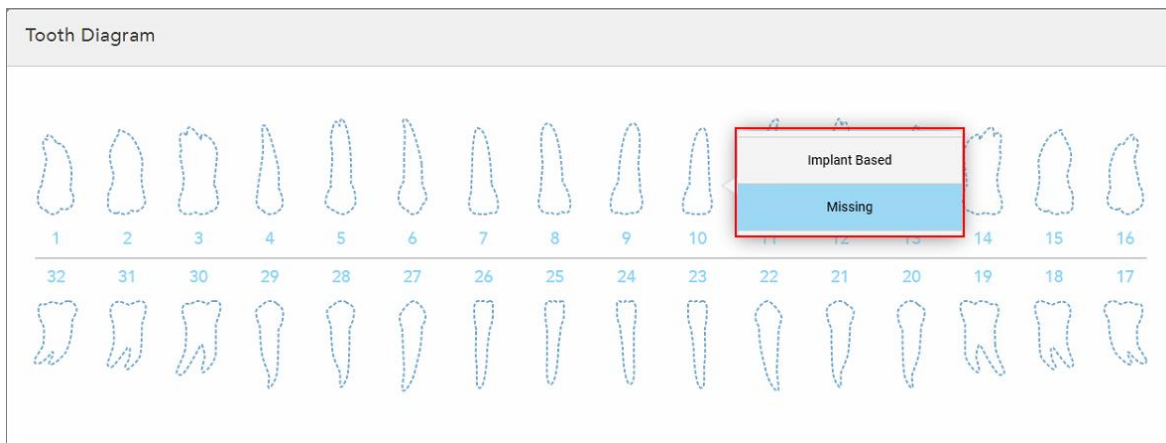

Figure 108: Defining the teeth to be included in the denture – Full Denture Implant Based procedure type

- Partial Denture/Framework – Tap each relevant tooth and select either **Clasp** or **Missing**.
- Immediate Denture – Tap each relevant tooth and select either **Clasp** or **To Be Removed**.

- Full Denture Implant Based – Tap each relevant tooth and select either **Implant Based** or **Missing**. If you select **Implant Based**, the *Implant Based* settings window is displayed, with all fields mandatory.

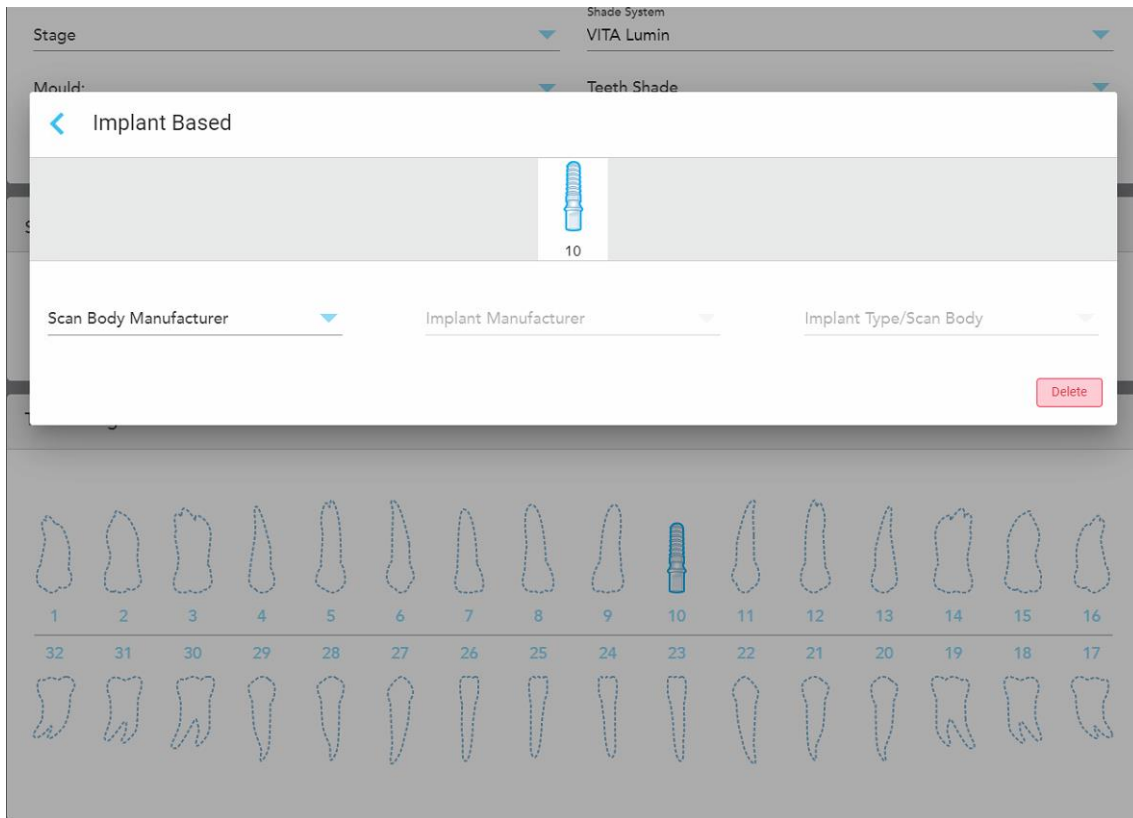



Figure 109: Implant Based settings window

- For each Implant-based tooth, select the scan body manufacturer, the implant manufacturer, and the implant type/scan body from the relevant drop-down lists.
  - Tap  to save your changes and return to the *New Scan* window.
- The **Treatment Information** area displays all indications for each tooth. If required, edit the details for each tooth by tapping **Show Details**.
  - In the **Notes** area, if required, enter any specific notes to the lab regarding the patient's treatment. For example, special instructions for delivery or manufacturing. Tap anywhere outside the **Notes** area to add the note. Each note shows the author of the note, with a timestamp, and can be edited and deleted.
  - Tap  on the toolbar to move to Scan mode, as described in [Scanning the patient](#).
 

**Note:** Excess soft tissue will not be removed automatically from around the edges of the model during scanning. If required, you can enable automatic cleanup by pressing on the screen and then tapping the Auto Cleanup tool. For more information, see [Disabling auto-cleanup](#).

### 5.3.6 Filling in the Rx for Appliance procedures

The Appliance procedure enables you to create a prescription for various dental appliances, such as night guards and sleep appliances.

#### To fill in the Rx for an Appliance procedure:

1. In the **Patient** area, enter a patient's details or search for an existing patient, as described in [Searching for existing patients](#).
2. In the **Order** area, select **Appliance** from the **Procedure** drop-down list.
3. From the **Type** drop-down list, select the type of appliance required. If the required appliance is not listed, select **Ortho Appliance** and then enter your requirements in the **Notes** area at the bottom of the window.

The screenshot displays the 'Order' section of the software interface. It features a 'Procedure' dropdown menu currently set to 'Appliance'. Below it is a 'Due Date' field. The 'Scan Options' section includes a toggle for 'NIRI Capture' which is turned on, and a toggle for 'New Sleeve Attached' which is turned off. A 'Type' dropdown menu is open, showing a list of appliance types: Night Guard, Bite Splint, Sports/Mouth Guard, Apnea/Sleep Appliance, and Ortho Appliance. The 'Type' dropdown is highlighted with a red border.

Figure 110: Appliance procedure types

4. Continue filling in the prescription from step 5, as described in [Filling in the Rx](#).

### 5.3.7 Disabling NIRI data capture

**Note:** This section is not relevant for iTerо Element 5D Plus Lite systems.

When patients are scanned, the NIRI data is captured by default. If required, you can disable capturing the NIRI data before starting a new scan. In this case, none of the NIRI features are displayed in the GUI, and NIRI data is not captured, saved, or sent.

NIRI capture can also be disabled by default for all scans, as described in [Disabling NIRI data capture for all scans](#).

**To disable NIRI data capture for a specific scan:**

- Before starting a new scan, in the *New Scan* window, turn off the **NIRI Capture** toggle.

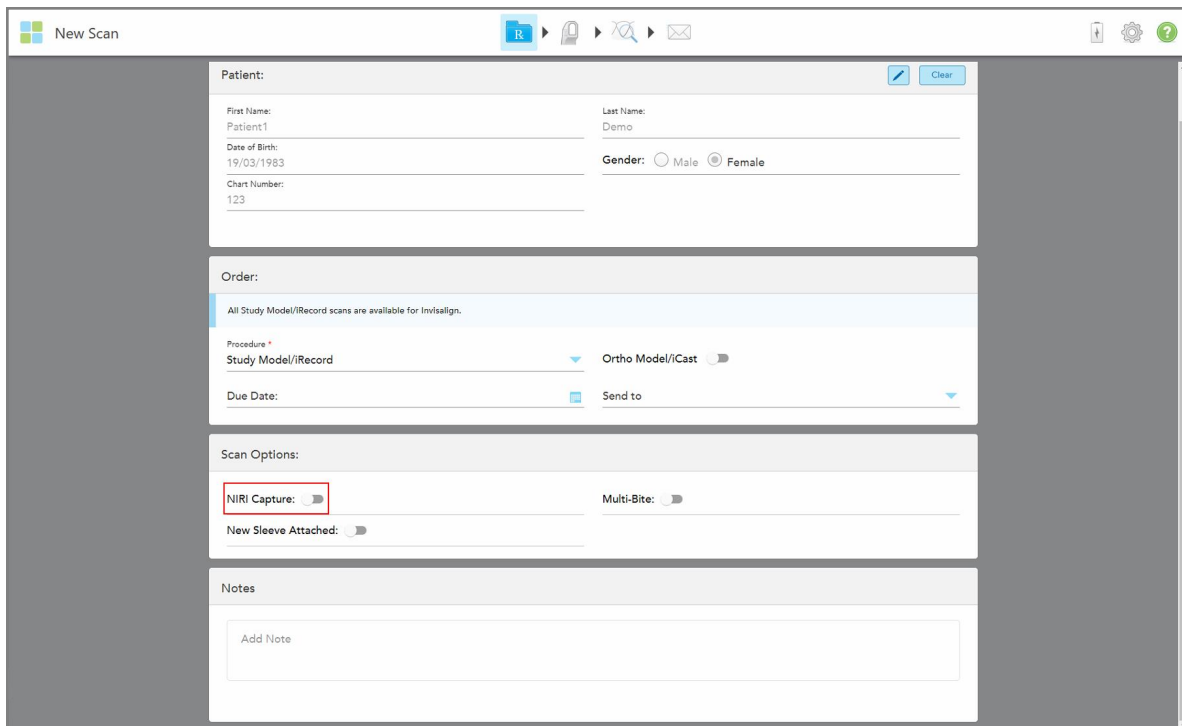

The screenshot shows the 'New Scan' window with the following sections:

- Patient:** Fields for First Name (Patient1), Last Name (Demo), Date of Birth (19/03/1983), and Chart Number (123). Gender is set to Female.
- Order:** A message: 'All Study Model/Record scans are available for Invisalign.' Below it, 'Procedure \*' is 'Study Model/Record', 'Ortho Model/ICast' is a toggle switch, and 'Due Date:' and 'Send to' are also present.
- Scan Options:** 'NIRI Capture:' is a toggle switch that is turned off (indicated by a red box in the original image). 'Multi-Bite:' is another toggle switch. 'New Sleeve Attached:' is also a toggle switch.
- Notes:** A text area with the placeholder 'Add Note'.

Figure 111: Disabling NIRI data capture for a specific scan

**Note:** This option cannot be changed after you have started scanning.



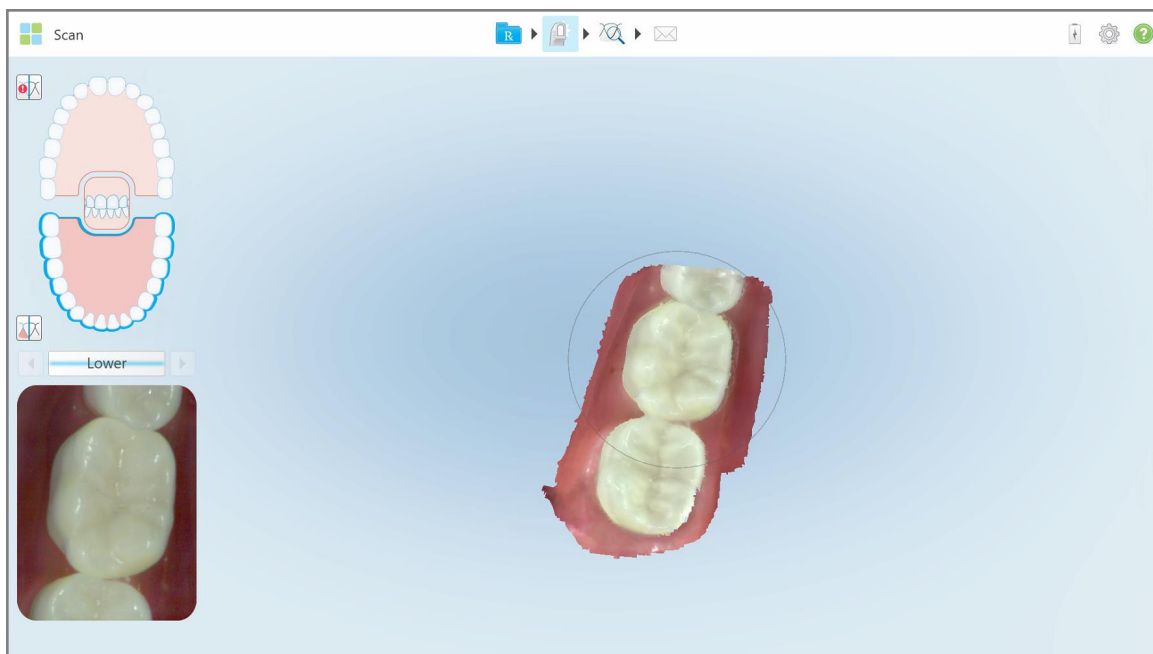

Figure 112: Scan tool without the option to display NIRI data in the viewfinder or to enlarge the viewfinder

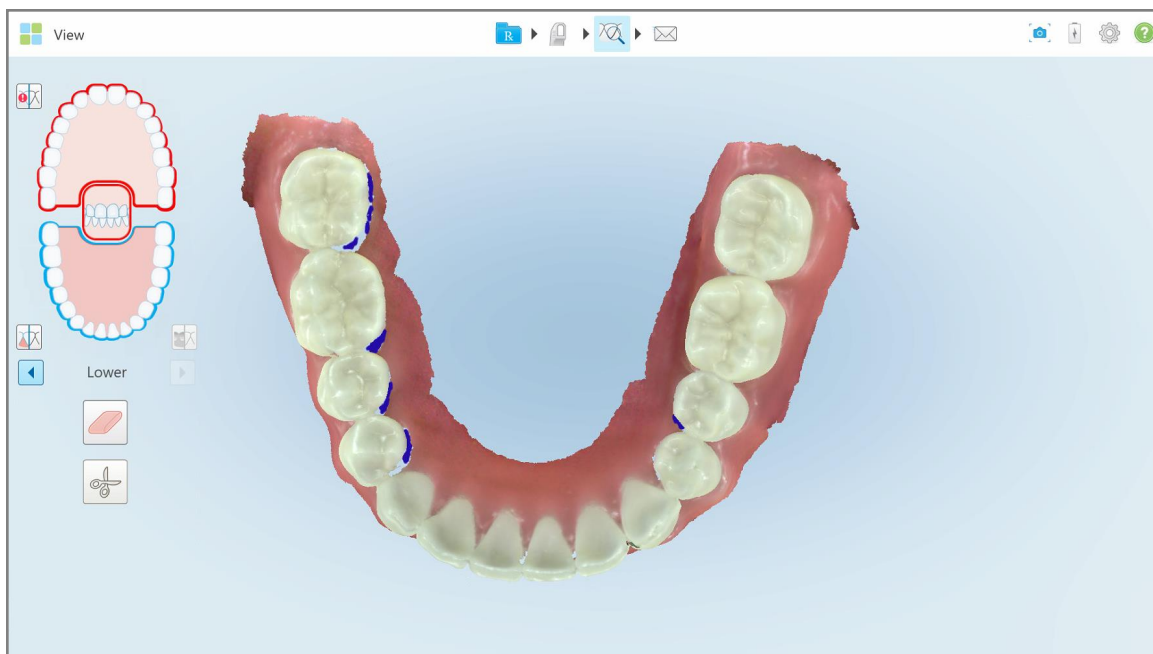



Figure 113: Review tool is not displayed in View mode

After scanning, you can view the NIRI status of each scan in the *Orders* page on the scanner and in MyiTero.

### 5.3.8 Confirming a new wand sleeve between patients

In order to prevent cross-contamination, you must replace the wand sleeve for each patient.

In iTerо Element 5D Plus systems, you are required to confirm the new wand sleeve using one of the following options:

- Activating the **New Sleeve Attached** option when filling in a new Rx, as described in [Confirming the new sleeve when filling in the Rx](#). This method is minimally intrusive and will not alarm the patient.
- Pressing either of the wand buttons or tapping **OK** when prompted, when trying to access Scan mode  as described in [Confirming the new sleeve when accessing Scan mode](#).

Failure to confirm a new sleeve will block you from starting a new scan.

Both methods of sleeve confirmation are documented in the log file, which contains the name of the user who confirmed the new sleeve, as well as the timestamp.

**Note:** The following sections describing the sleeve confirmation in the software are not relevant for iTerо Element 5D Plus Lite systems.

#### 5.3.8.1 Confirming the new sleeve when filling in the Rx

In the *New Scan* window, turn on the **New Sleeve Attached** toggle to confirm that a new sleeve is attached to the wand.

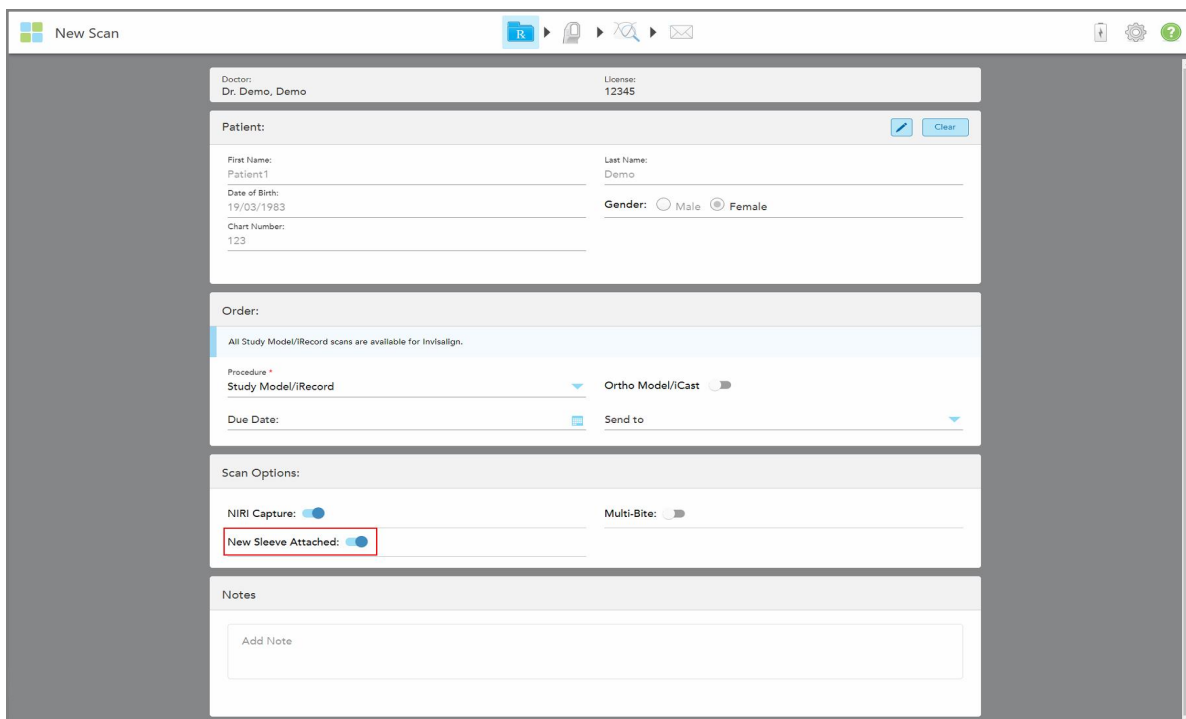

The screenshot shows the 'New Scan' window with the following sections:

- Doctor:** Dr, Demo, Demo | **License:** 12345
- Patient:**
  - First Name: Patient1 | Last Name: Demo
  - Date of Birth: 19/03/1983 | Gender:  Male  Female
  - Chart Number: 123
- Order:**
  - All Study Model/Record scans are available for Invisalign.
  - Procedure: Study Model/iRecord | Ortho Model/iCast:
  - Due Date: | Send to:
- Scan Options:**
  - NIRI Capture:  | Multi-Bite:
  - New Sleeve Attached:**  (highlighted with a red box)
- Notes:** Add Note

Figure 114: Confirming that a new sleeve is attached

- If the **New Sleeve Attached** toggle is turned on, you will not see any further messages and are able to scan upon entry to Scan mode.

- If the **New Sleeve Attached** toggle is not turned on, you will be blocked from accessing Scan mode and will have to confirm the new sleeve, as described in the following section.

### 5.3.8.2 Confirming the new sleeve when accessing Scan mode

If you did not turn on the **New Sleeve Attached** toggle when filling in the new Rx, the following message is

displayed when tapping the Scan tool :

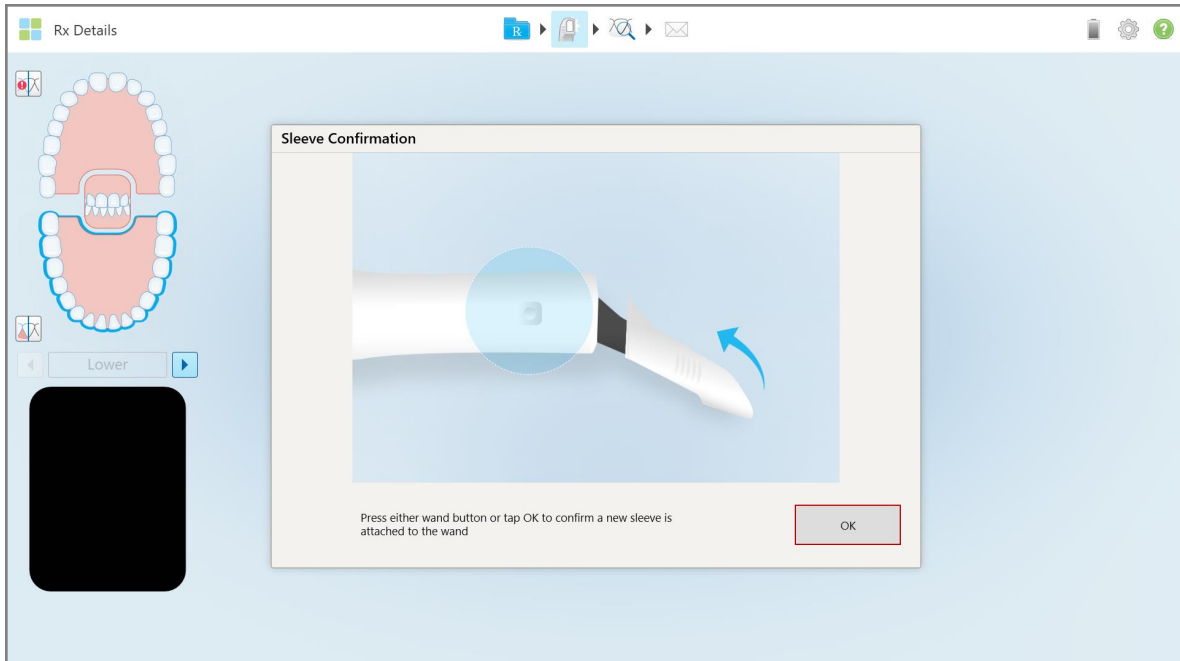

Figure 115: Popup confirmation message before scanning

You are blocked from scanning until you tap **OK** on the screen or press either of the wand buttons.

## 5.4 Patient management

You control the patient's data-management process from the **Patient** area in the *New Scan* window.

- Add a new patient, as described in [Adding new patients](#)
- Search for an existing patient, as described in [Searching for existing patients](#)
- Edit a patient's details, as described in [Editing the patient details](#)
- Clear the patient data from the *New Scan* window, as described in [Clearing the patient details from the New Scan window](#)

### 5.4.1 Adding new patients

You can add a new patient while filling in the Rx. The patient's details will be saved once you move to the *Scan* window and can later be edited, as described in [Editing the patient details](#).

In addition, you can add new patients using MyiTero or your Dental Program Management Services (DPMS) software.

#### To add a new patient:

1. In the *New Scan* window, in the **Patient** area, enter the patient's first name and last name.
2. If required, enter the patient's date of birth in DD/MM/YYYY format, select the patient's gender, and enter a unique identifier as the patient's chart number.

The new patient's details are displayed in the **Patient** area of the *New Scan* window.

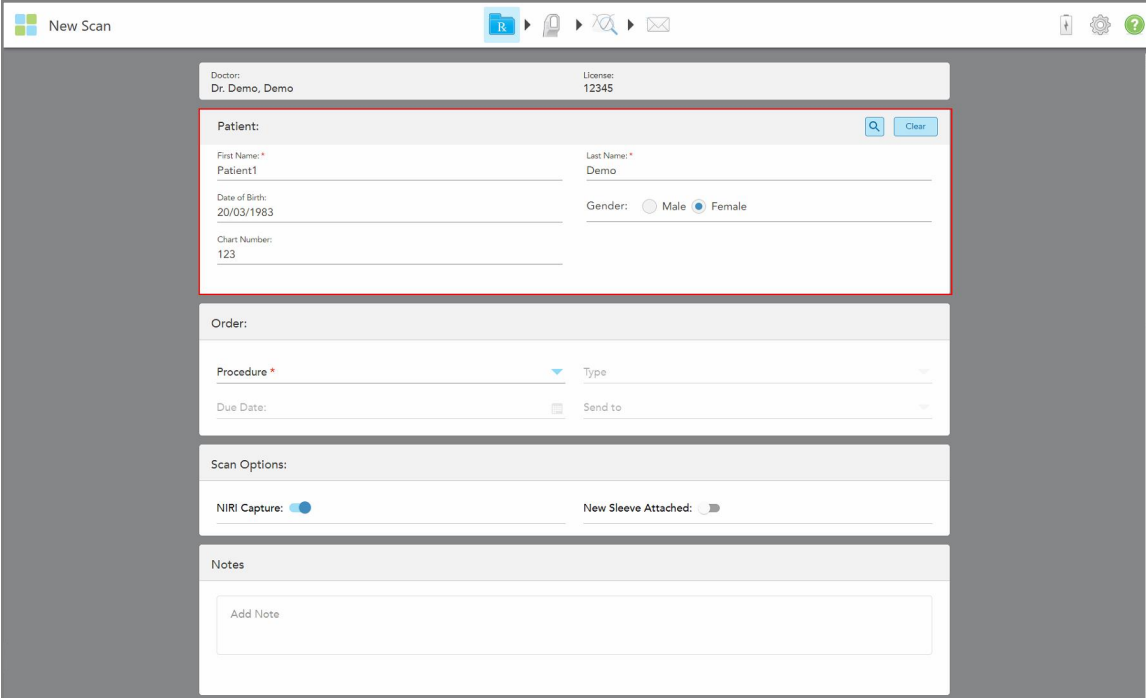

The screenshot shows the 'New Scan' window with a patient details form highlighted by a red border. The form includes the following fields:

- Doctor: Dr. Demo, Demo
- License: 12345
- Patient: (Search icon) (Clear button)
- First Name\*: Patient1
- Last Name\*: Demo
- Date of Birth: 20/03/1983
- Gender:  Male  Female
- Chart Number: 123

Below the patient details, there are sections for 'Order' (Procedure, Type, Due Date, Send to) and 'Scan Options' (NIRI Capture: , New Sleeve Attached: ). A 'Notes' section with an 'Add Note' button is at the bottom.

Figure 116: Adding a new patient

**Note:** If you try adding a patient who already exists, the **First Name**, **Last Name**, and **Chart Number** fields are highlighted, and a message is displayed notifying you that a patient with the same details already exists.

The screenshot shows a 'Patient' form with the following fields: First Name (\*), Last Name (\*), Date of Birth, Gender (Male/Female), and Chart Number. The fields for First Name, Last Name, and Chart Number are highlighted with a red border. A yellow message box at the bottom states: 'A patient with the same details already exists: Demo, Patient2. Load existing patient or edit highlighted fields above to create a new patient.' There are search and clear buttons in the top right corner.

Figure 117: Message notifying that a patient with the same details exists

- If the new patient and the existing patient are the same person, tap **Load existing patient**.
- If the new patient and the existing patient are different people, edit the highlighted fields – First Name, Last Name, or Chart Number – to create a new patient.

The patient's details are displayed in the *New Scan* window.

#### 5.4.2 Searching for existing patients

When searching for an existing patient, you must enter at least 3 characters of the patient's name in the search field to see a list of patients who match the search criteria.

In addition, you can search for a patient from the **Patients** page, described in [Searching for patients](#).

**To search for an existing patient:**

- In the *New Scan* window, in the **Patient** area, tap .

The screenshot shows the 'Patient' form with the search icon in the top right corner highlighted with a red box. The form fields are: First Name (\*), Last Name (\*), Date of Birth, Gender (Male/Female), and Chart Number.

Figure 118: Patient area of the New Scan window – searching for an existing patient

The *Search Patient* window is displayed.

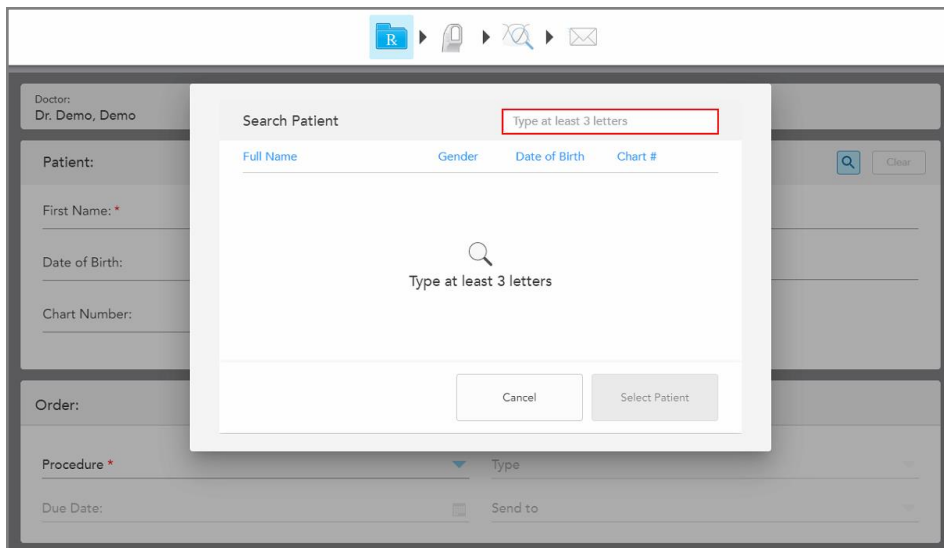

Figure 119: Search Patient window with a search field

2. In the *Search Patient* window, enter at least three letters in the search field to display a list of patients matching the search criteria.

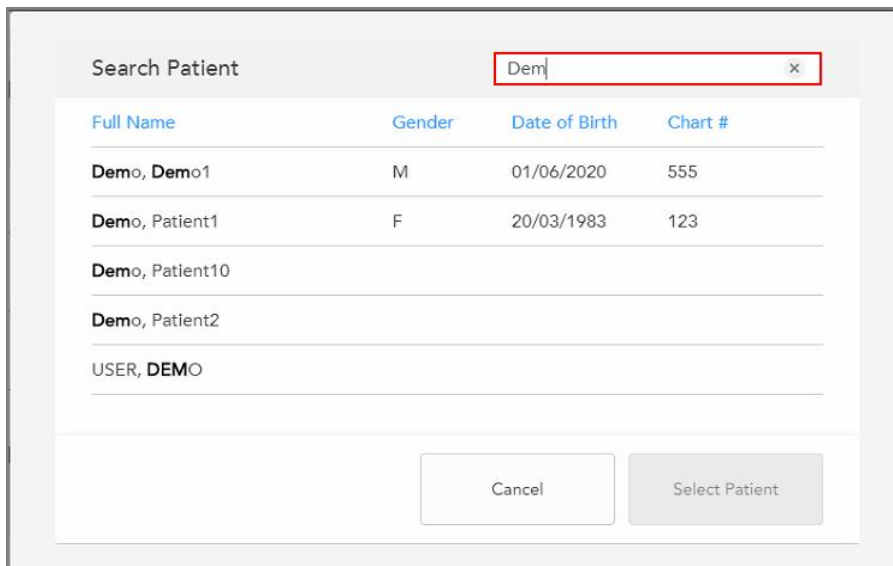

Figure 120: Search criteria in the search field and list of matching patients

3. Select the required patient, and then tap **Select Patient**.

Search Patient

Full Name	Gender	Date of Birth	Chart #
Demo, Demo1	M	01/06/2020	555
Demo, Patient1	F	20/03/1983	123
Demo, Patient10			
Demo, Patient2			
USER, DEMO			

Figure 121: Selecting the required patient

The selected patient is displayed in the **Patient** area of the *New Scan* window.

Doctor: Dr. Demo, Demo License: 12345

Patient:

First Name: Patient1 Last Name: Demo

Date of Birth: 20/03/1983 Gender:  Male  Female

Chart Number: 123

Figure 122: Selected patient displayed in the Patient area of the New Scan window

### 5.4.3 Editing the patient details

After you have searched for and selected a patient, or after you have added a new patient, you can edit the patient's details.

In addition, you can edit the patient's details when opening the Rx from the patient's profile page, as described in [Viewing the Rx](#).

**To edit a patient's details:**

1. Search for an existing patient, as described in [Searching for existing patients](#).  
The patient is displayed in the *New Scan* window.

2. In the **Patient** area, tap .



Patient: 

First Name: Patient2  
Last Name: Demo

Date of Birth: \_\_\_\_\_  
Gender:  Male  Female

Chart Number: \_\_\_\_\_

**Figure 123: Patient area of New Scan window – editing a patient**

The *Edit Patient* window is displayed.

3. Edit the patient's details as required and then tap **Update**.

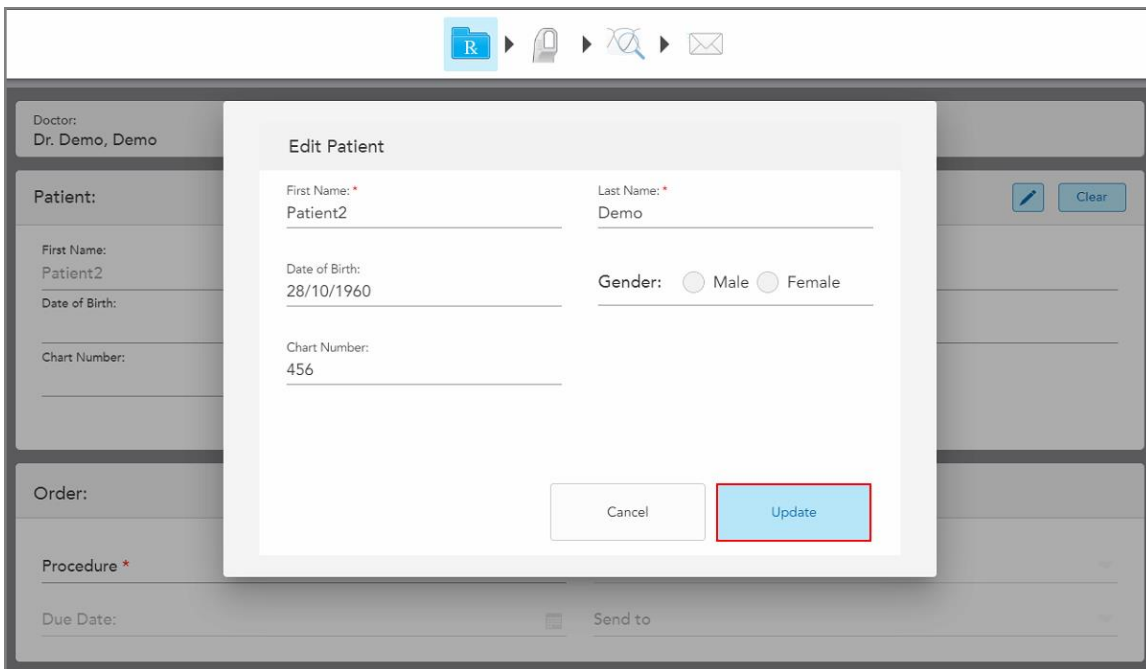

Doctor: Dr. Demo, Demo

Patient: 

First Name: Patient2  
Last Name: Demo

Date of Birth: 28/10/1960  
Gender:  Male  Female

Chart Number: 456

Order: \_\_\_\_\_

Procedure \* \_\_\_\_\_

Due Date: \_\_\_\_\_

**Figure 124: Edit Patient window and Update button**



If, while editing the patient's name, you enter the same details as an existing patient, a message is displayed notifying you of such.

The screenshot shows the 'Edit Patient' form with the following fields and values:

- First Name: \***: Patient 1
- Last Name: \***: Demo
- Date of Birth:** (empty)
- Gender:**  Male  Female
- Chart Number:** (empty)

A red message box at the bottom of the form states: "A patient with the same details already exists: Demo, Patient 1". Below the message box are two buttons: "Cancel" and "Update".

Figure 125: Message that a patient with the same details already exists

To differentiate between patients with the same details, enter a unique identifier in the **Chart Number** field.

#### 5.4.4 Clearing the patient details from the New Scan window

If required, you can remove the currently-displayed patient's details from the *New Scan* window.

**To clear the patient details from the New Scan window:**

1. In the **Patient** area, tap .

The screenshot shows the 'Patient' form with the following fields and values:

- First Name:** Patient1
- Last Name:** Demo
- Date of Birth:** 19/03/1983
- Gender:**  Male  Female
- Chart Number:** 123

A blue 'Clear' button is highlighted in the top right corner of the form.

Figure 126: Clear patient details button

A confirmation message is displayed.

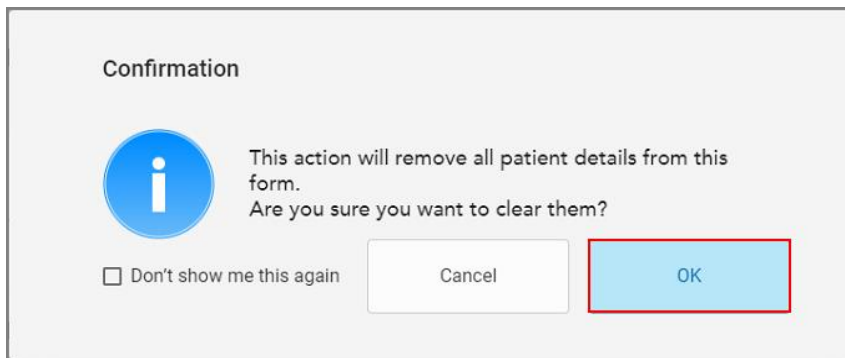



Figure 127: Clear confirmation message

2. Tap **OK** to clear the patient's details.

If required, you can select the **Don't show me this again** check box. In the future, the patient details will be cleared from the *New Scan* window as soon as you tap the **Clear** button.

All data is cleared from the *New Scan* window, and you can now add a new patient or search for an existing patient, if required.

## 5.5 Scanning the patient

After you have filled in the Rx, tap  on the toolbar to enter Scan mode. The *Scan* window is displayed, enabling you to start scanning the patient.

The iTerO Element 5D scanner provides simultaneous capture and display of NIRI, 2D color images, and 3D intraoral optical impression data.

**Note:** iTerO NIRI technology is not supported by iTerO Element 5D Plus Lite systems.

While in Scan mode, you can perform the following actions:

- View additional scan feedback, described in [Additional scan feedback](#)
- Toggle between color and monochrome mode, described in [Scan color toggle](#)
- Toggle between the 3D and the viewfinder display, described in [Toggling the 3D and viewfinder display](#)
- Toggle between displaying a color image or a NIRI image in the viewfinder, as described in [Toggling between color and NIRI images in the viewfinder](#) – relevant for iTerO Element 5D and iTerO Element 5D Plus systems only

You can also edit the scan, as follows:

- Delete a segment, as described in [Deleting a segment](#)
- Delete a selected area, as described in [Deleting a selection](#)
- Capture areas with missing anatomy, as described in [Filling in missing anatomy](#)
- Display the excess tissue around the edges of the 3D model, as described in [Disabling auto-cleanup](#)

When you have finished scanning the patient, tap  on the toolbar to move to **View** mode, where you can review the scan.

### 5.5.1 Scanning guidance

As soon as you move to Scan mode, the recommended scanning sequence for the selected scan segment is displayed in the center of the scanner window. It will automatically disappear after a short while, or you can tap anywhere on the screen to hide it.

iTero recommends you follow the scanning sequence for best results.

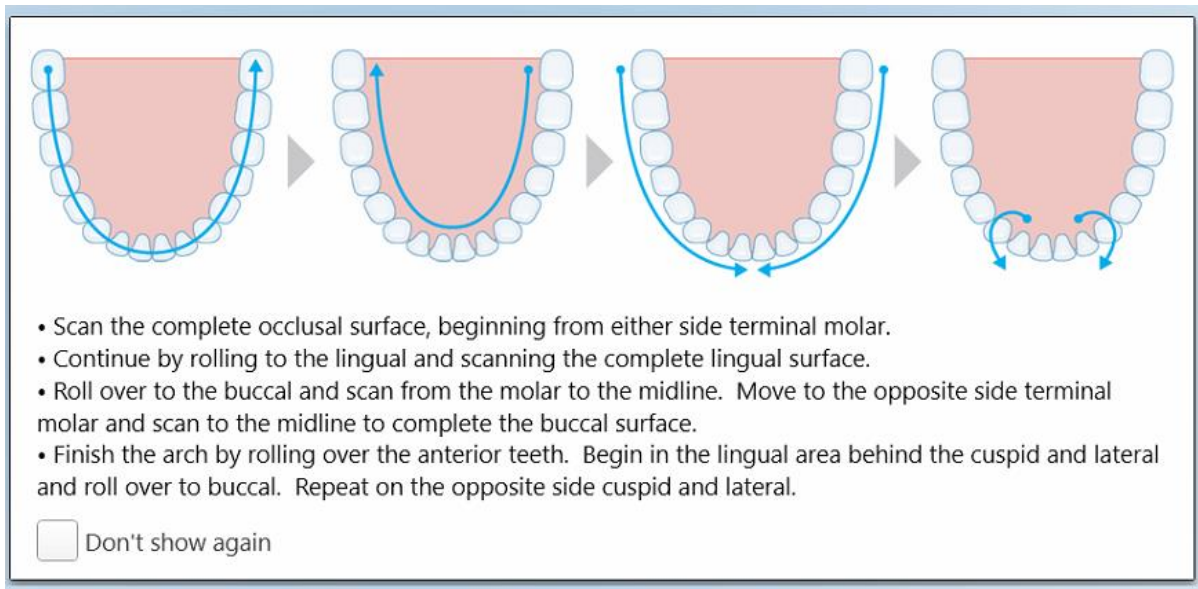

Figure 128: Recommended scanning sequence – lower jaw

**Note:** If you select the **Don't show again** check box, this guidance will not be displayed in future scans. You can return the guidance by enabling it in the **Scan** settings, as described in [Defining the scan settings](#).

In addition, if you press both wand buttons simultaneously, the following guidance is displayed:

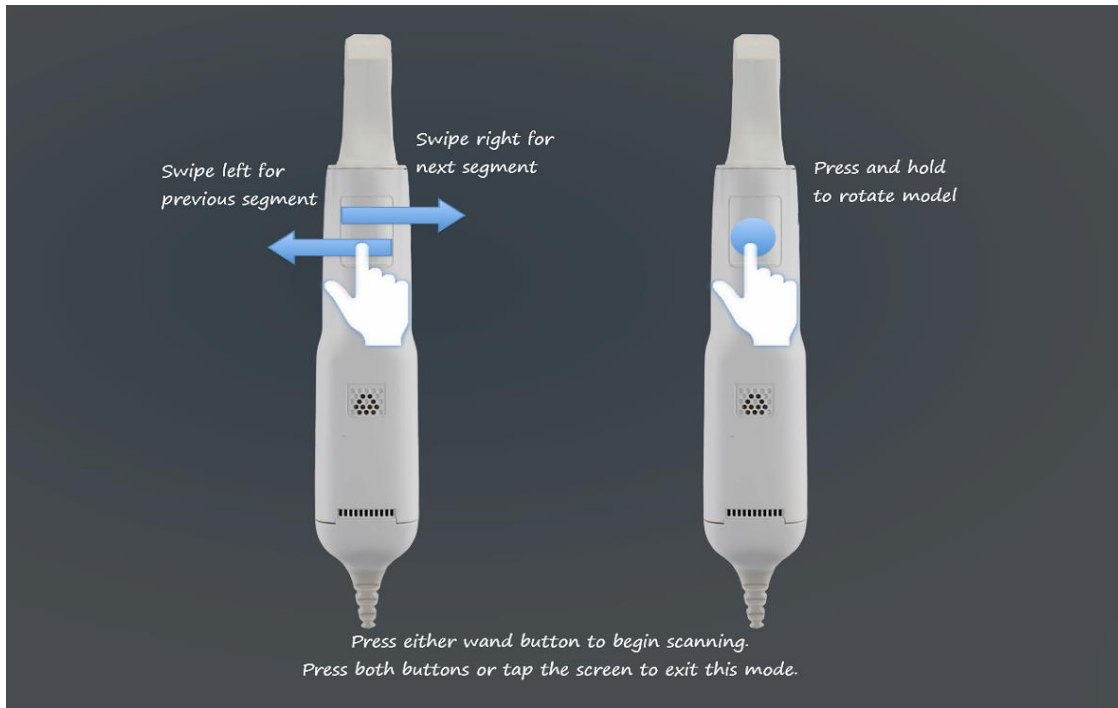

Figure 129: Wand guidance

Press either of the wand buttons to begin scanning.

To allow optimal capturing of the NIR images, the wand should be held 0-3mm above the patient's teeth.

### 5.5.2 Scanning best practices

iTerо recommends the following best practices for scanning fixed restorative procedures:

- Ensure that the prepped tooth and the surrounding area are free of debris, saliva, and blood contamination.
- The prepped tooth should be dry, and the margin line should be clear of tissue.
- You should be familiar with proper scanning techniques and avoid over scanning.

### 5.5.3 Scan options

In Scan mode, you can select the following options:

- Additional scan feedback, described in [Additional scan feedback](#)
- Toggle color/monochrome, described in [Scan color toggle](#)
- Toggle between the 3D and the viewfinder display, described in [Toggling the 3D and viewfinder display](#)
- Toggle between displaying a color image or a NIRI image in the viewfinder, as described in [Toggling between color and NIRI images in the viewfinder](#) – relevant for iTerо Element 5D and iTerо Element 5D Plus systems only

- Edit the scan:
  - Delete a segment, described in [Deleting a segment](#)
  - Delete a selection, described in [Deleting a selection](#)
  - Fill in missing anatomy, described in [Filling in missing anatomy](#)
  - Disable auto cleanup, described in [Disabling auto-cleanup](#)

### 5.5.3.1 Additional scan feedback



You can activate the additional scan feedback mode  to alert you to the areas that need additional scanning, to ensure that critical areas that could compromise the whole model are not missed.

Areas with missing anatomy are highlighted in red when scanning in monochromatic mode, and purple when scanning in color mode.

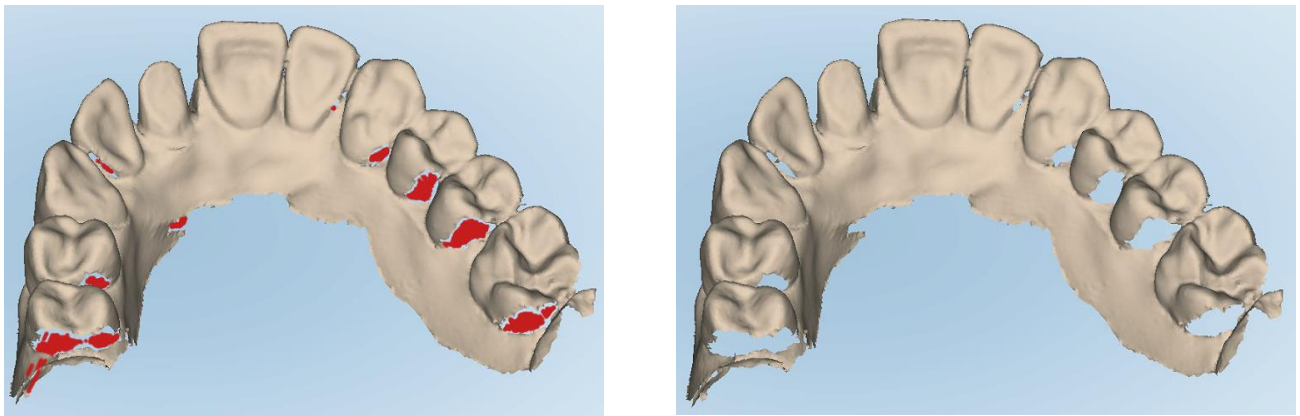

Figure 130: Areas with missing anatomy shown with and without additional scan feedback – monochrome

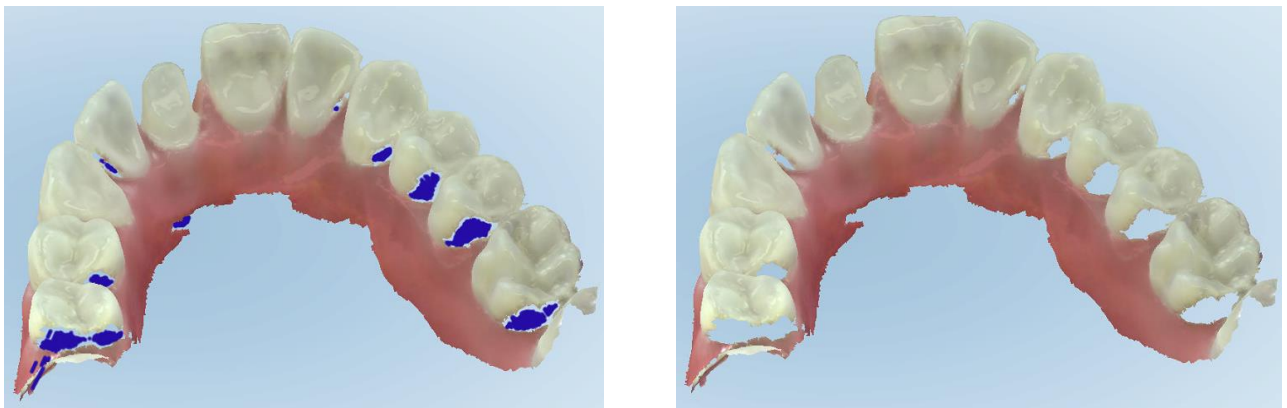



Figure 131: Areas with missing anatomy shown with and without additional scan feedback – color mode

By default, this mode is enabled, but it can be disabled per case by tapping  or by default in the Scan settings, as described in [Defining the scan settings](#).

### 5.5.3.2 Scan color toggle

The color toggle button  allows you to toggle between color and monochromatic modes. This applies to both scanning and viewing all procedures.

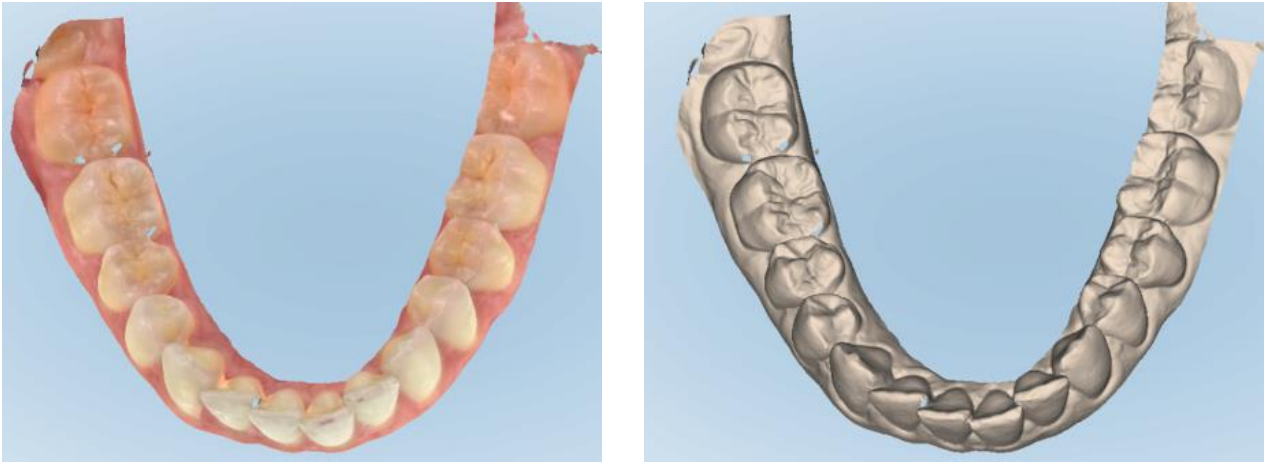



Figure 132: Model displayed in color and monochrome mode

By default, models are scanned in color, but you can toggle the display per case by tapping  or by default in the Scan settings, as described in [Defining the scan settings](#).

### 5.5.3.3 Switching to the next scan segment

During scanning, the current segment is highlighted in blue in the navigation controls, and also displayed in the segment indicator box, between the arrows.

**Note:** Before moving to the next segment, press either of the wand side buttons to stop the wand from scanning. The system emits a sound when stopping the scan and again when restarting the scan.

You can move to the next segment by:

- Tapping on the relevant arch, prepped tooth, or bite segment
- Tapping the arrows

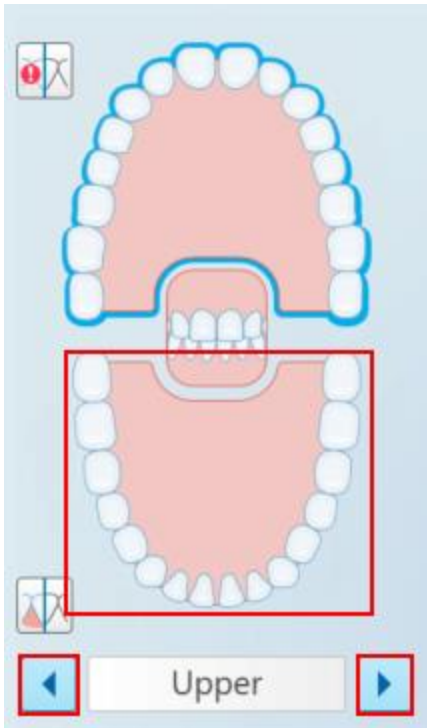

Figure 133: Tap the opposite arch or tap the arrows to select it

- Swiping to the left or the right on the wand touchpad.  
To enable the wand touchpad, press and release both wand buttons simultaneously.

#### 5.5.4 Toggling the 3D and viewfinder display

By default, when scanning the patient's teeth, a large 3D image of the scan is displayed in the center of the screen and the area currently being scanned is displayed in the viewfinder on the bottom left of the window.

In order to facilitate exploring a specific area of interest, you can switch the display to show an enlarged viewfinder in the center of the window, and a smaller 3D image displayed on the side of the window.

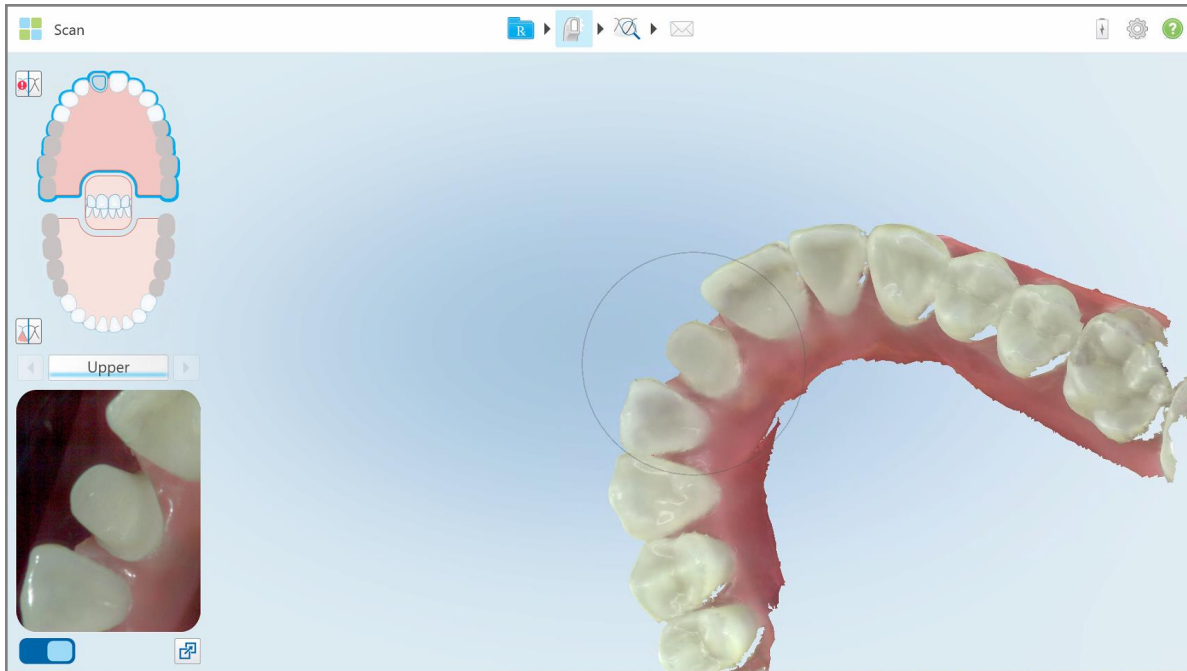



Figure 134: Default view – 3D scan in the center of the window and viewfinder on the left

- To switch to a large viewfinder in the center of the screen, tap the  button.

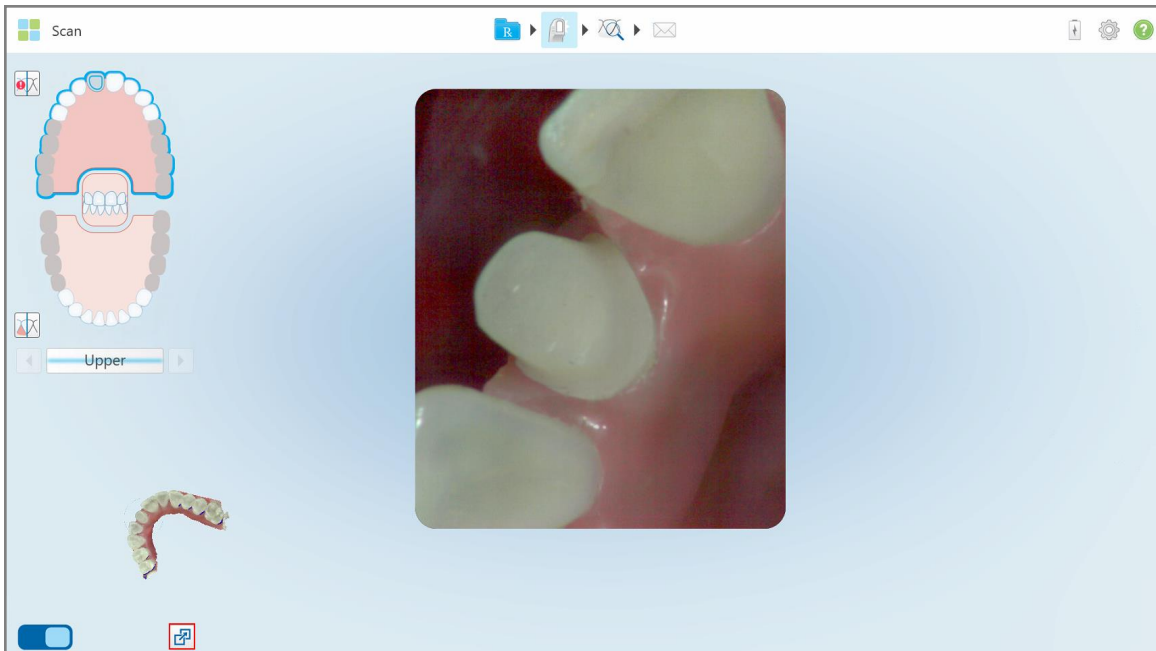



Figure 135: Large viewfinder in the center of the screen and 3D image on the left



### 5.5.5 Toggling between color and NIRI images in the viewfinder

**Note:** This section is not relevant for iTero Element 5D Plus Lite systems.

In addition to moving the viewfinder, you can toggle the display to show the viewfinder image either in color or as a NIRI image.

- Tap  to toggle between displaying a color image or a NIRI image in the viewfinder.

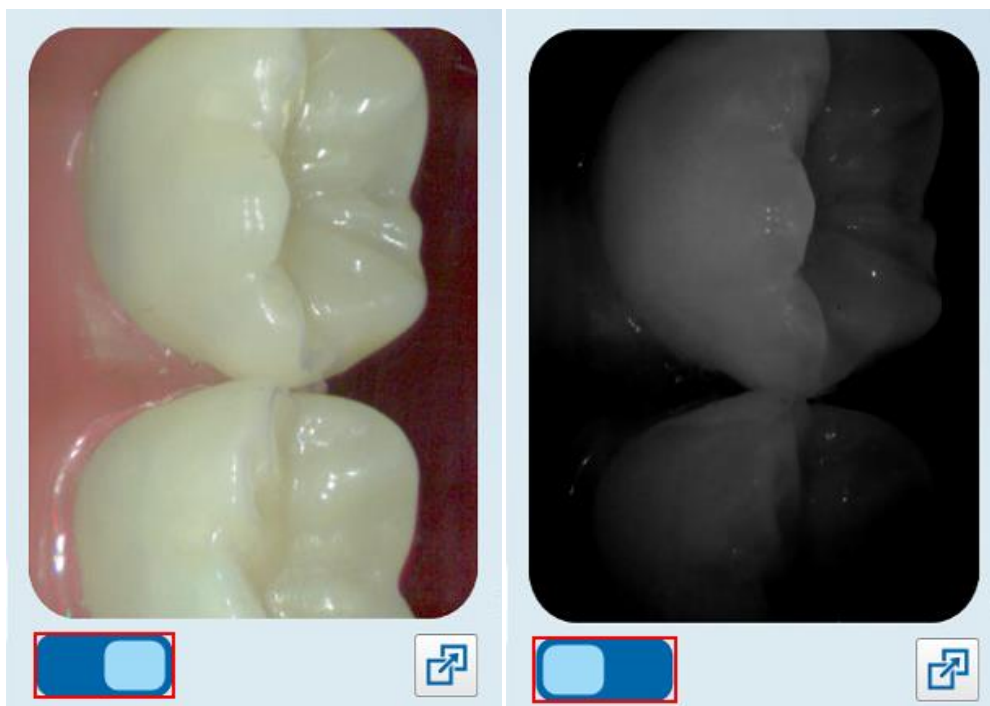

Figure 136: Viewfinder displaying a color image (left) or a NIRI image (right)

### 5.5.6 Editing a scan

After you have scanned the model, you can edit it using the following tools:

- Delete Segment tool, described in [Deleting a segment](#)
- Delete Selection tool, described in [Deleting a selection](#)
- Fill tool, described in [Filling in missing anatomy](#)
- Disable auto-cleanup tool, described in [Disabling auto-cleanup](#)

The editing tools are accessed by pressing on the screen.

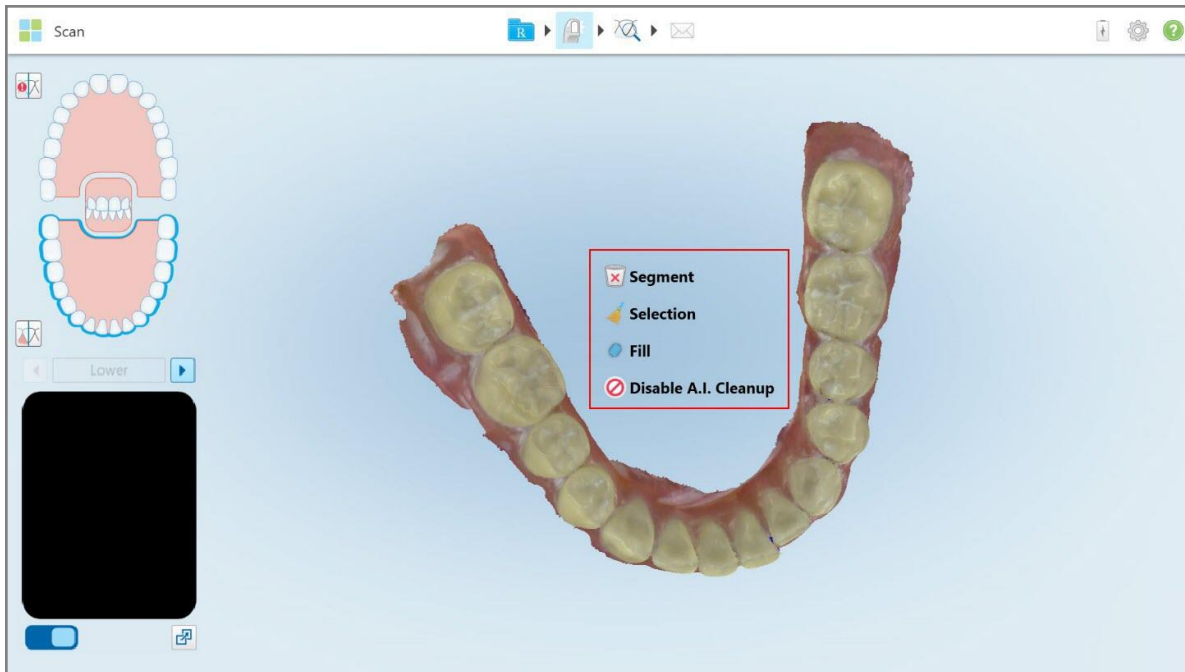



Figure 137: Editing tools

## 5.6 Viewing the scan

After scanning the patient, tap  to move to View mode. After the post-processing stage is complete, you can inspect the model in high resolution to ensure that sufficient anatomy has been captured, and that the model is accurate and complete.

If there are missing scan segments or missing bites, a message will be displayed at the beginning of the post-processing stage notifying you of this and enabling you to go back and add the missing areas of the scan. For more information, see [Missing scan segment notifications](#).

While viewing the scan, you can:

- Delete selected areas of a scan, as described in [Working with the Eraser tool](#)
- Manually create the die separation if the green hint point was not on the center of the prepped tooth during scanning, as described in [Working with the Die Separation tool](#)
- Define the margin line, as described in [Working with the Margin Line tool](#)
- View an area of interest using the Review tool, as described in [Working with the Review tool \(iTerо Element 5D and 5D Plus\)](#) (iTerо Element 5D and 5D Plus) and [Working with the Review tool \(iTerо Element 5D Plus Lite\)](#) (iTerо Element 5D Plus Lite)
- Capture a screenshot of the model, as described in [Working with the Snapshot tool](#)

After you have reviewed the scan to ensure that it is complete, tap  on the toolbar to send the scan to the lab or your chairside software, as described in [Sending the scan](#).

**Note for Fixed Restorative and Denture/Removable procedures:** After viewing the scan, return to the *New Scan* window to fill in any mandatory fields that were not filled in. These fields were not mandatory when scanning the patient but must be filled in before sending the scan. If there are missing fields when sending the scan, a message is displayed, prompting you to fill in all mandatory fields highlighted in red in the **Treatment Information** area.

### 5.6.1 Missing scan segment notifications

If there are missing scan segments or bite scans when you tap the  button, you will be notified at the beginning of the post-processing stage, and you will be able to go back and add the missing areas of the scan, in order to reduce manual intervention later on.

Notifications are displayed in the following cases:

- Missing prep or arch – segments were not scanned or not stitched together properly
- Bite issues
- Missing bite
- Bite scanned from one side only
- Discrepancy between the left and the right bite scans

In addition, the bite section in the navigation controls is highlighted in red.

The message may be generic, or very specific to the issue including guidance on how to correct the issue. In some cases, you may be warned that the scan may be returned from the lab if you do not fix the issues.

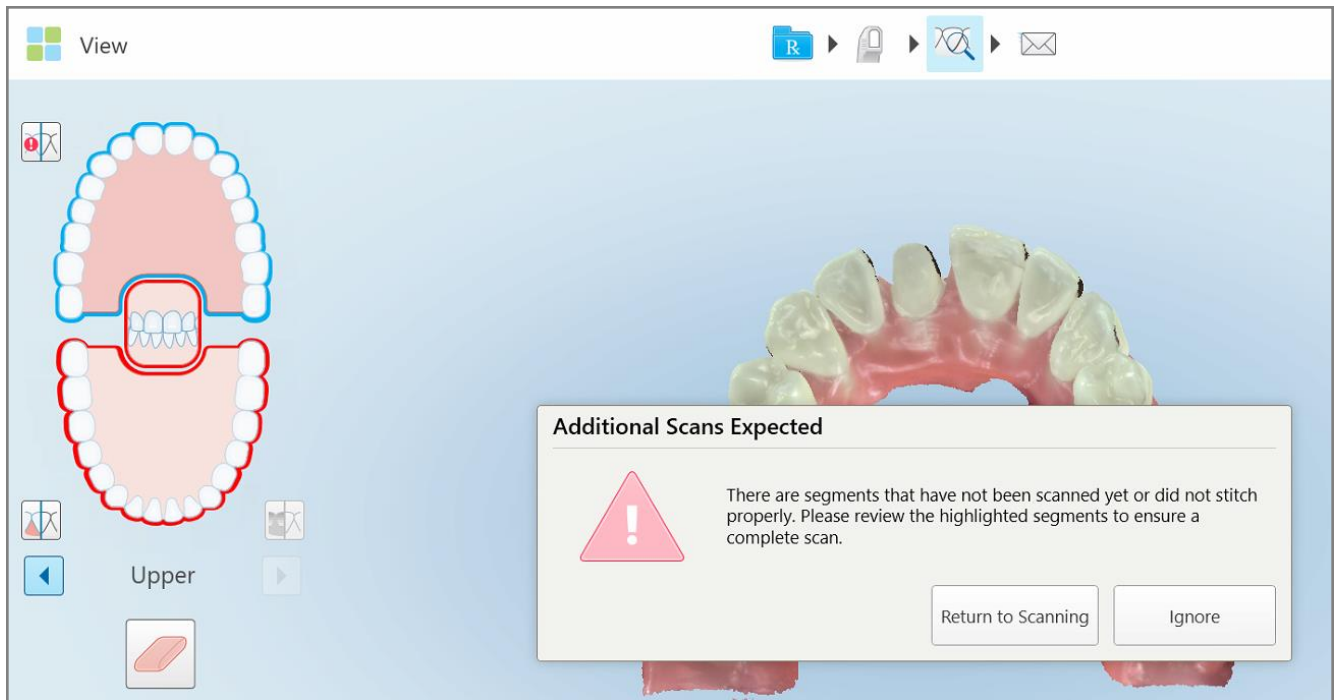



Figure 138: Missing scan message and missing segments highlighted in red

You can tap **Return to Scanning** to go back to Scan mode and rescan the missing segments, which are highlighted in red in the navigation controls.

### 5.6.2 Using the scan timer

The scan timer enables you to see how long it took to scan the model.

**To view the scan time:**

1. On the toolbar, tap the  button.

The scan time is displayed.



Figure 139: Scan timer button on the toolbar and scan time

2. Tap **OK** to close the window.

### 5.7 Sending the scan

After you have scanned the patient and reviewed the Rx to ensure that no data is missing, you can send the scan to the lab, chairside milling, or to storage, depending on the procedure.

**Note:** Before you can send the scan, you have to confirm that you have received the patient's consent to have their health data collected and processed by Align.

**To send the scan:**

1. Tap  on the toolbar to send the scan, including screenshots of the scanned model, if relevant.

**Note for Fixed Restorative and Denture/Removable procedures:** Some fields in the Rx become mandatory only after the patient has been scanned. If you have not completed all the mandatory information required, a message is displayed prompting you to fill in the missing fields.

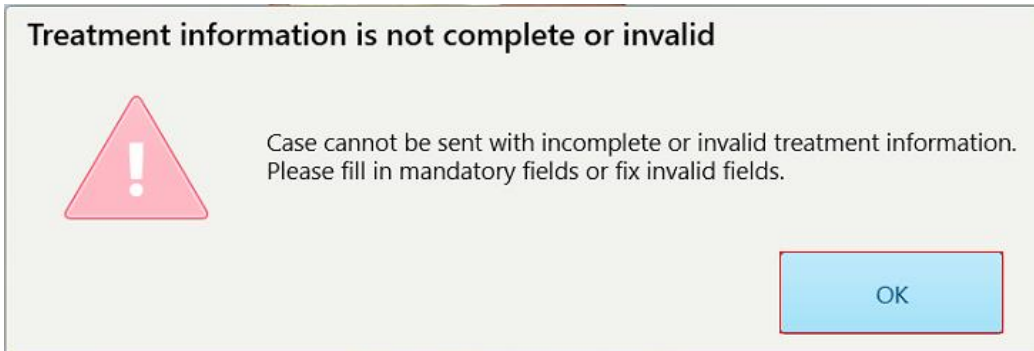

Figure 140: Notification about missing treatment information

- a. Tap **OK** to display the *Rx Details* page, showing a notification in the **Treatment Information** area for each treatment missing required fields.

Treatment Information					
Bridge : 14 - 16					
Tooth No.	Treatment	Specification	Material	Shade Body	
14	Implant Based	-	-	-	Show Details
Required Fields are Missing for Treatment					
15	Pontic	-	-	-	Show Details
Required Fields are Missing for Treatment					
16	Implant Based	-	-	-	Show Details
Required Fields are Missing for Treatment					

Figure 141: Missing fields highlighted in red in the Treatment Information area

- b. Tap **Show Details** to open the treatment options and fill in the missing details.

- c. Tap  to send the scan.

The *Send Confirmation* window is displayed.

2. Sign in the **Signature** area to authorize the order.

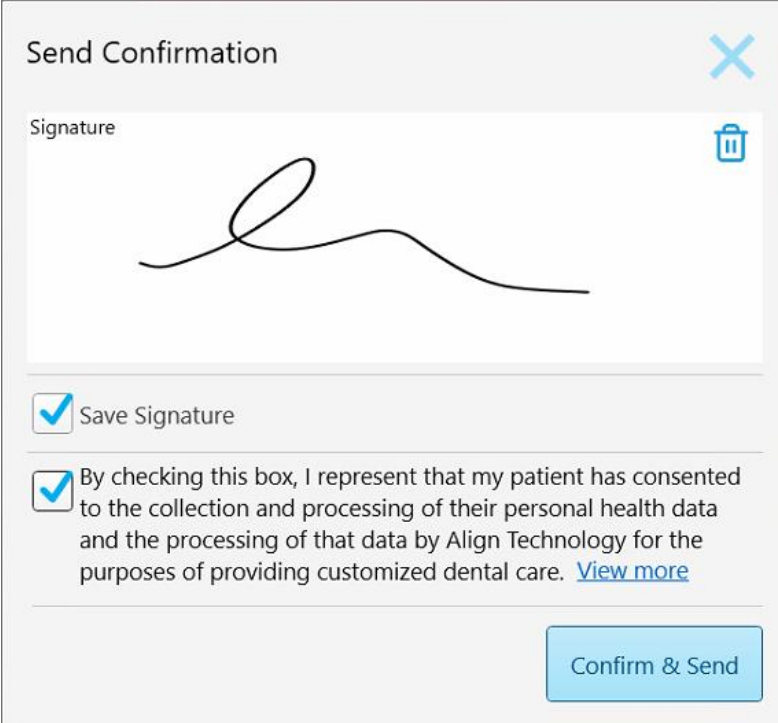

Send Confirmation

Signature

Save Signature

By checking this box, I represent that my patient has consented to the collection and processing of their personal health data and the processing of that data by Align Technology for the purposes of providing customized dental care. [View more](#)

Confirm & Send

Figure 142: Send Confirmation window

3. If required, select the **Save Signature** check box to save your signature for authorizing sending future scans.
4. If you have scanned a Study Model/iRecord procedure or an Invisalign Aligners procedure type, the **Initiate Invisalign Simulator Pro** check box is displayed and selected. Keeping this option selected will trigger the simulation. For more information regarding Invisalign Outcome Simulator Pro, see [Invisalign Outcome Simulator Pro](#).

**Notes:**

- In order to enable the simulation, ensure that your iTero account is paired with your Invisalign Doctor Site account.
  - Invisalign Outcome Simulator Pro is supported on iTero Element Plus series scanners only.
5. After receiving the consent of the patient to have their data processed and sent to Align, ensure that the patient consent check box is selected.
  6. Tap **Confirm & Send** to send the scan.

A notification is displayed that the model is being sent and then the patient's profile page is displayed showing the status of the order.

If you selected to run an Invisalign Outcome Simulator Pro simulation, the Viewer is displayed showing the progress of the simulation.

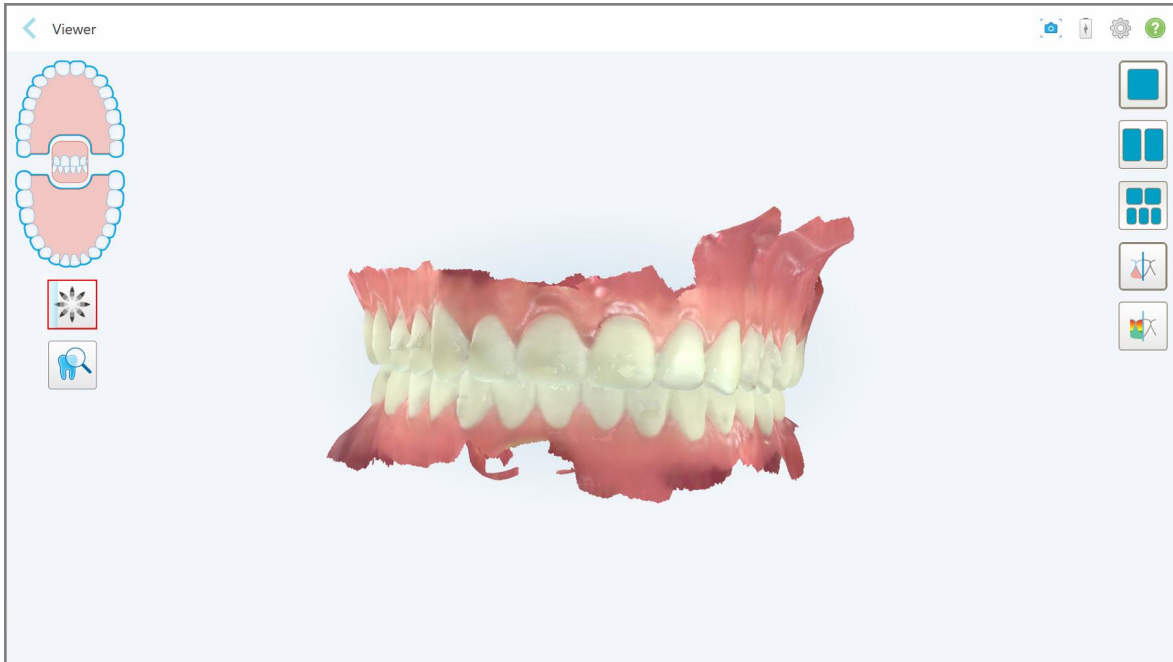

Figure 143: Invisalign Outcome Simulator Pro progress shown in the Viewer

You can also view the progress of the simulation in the patient's profile page.

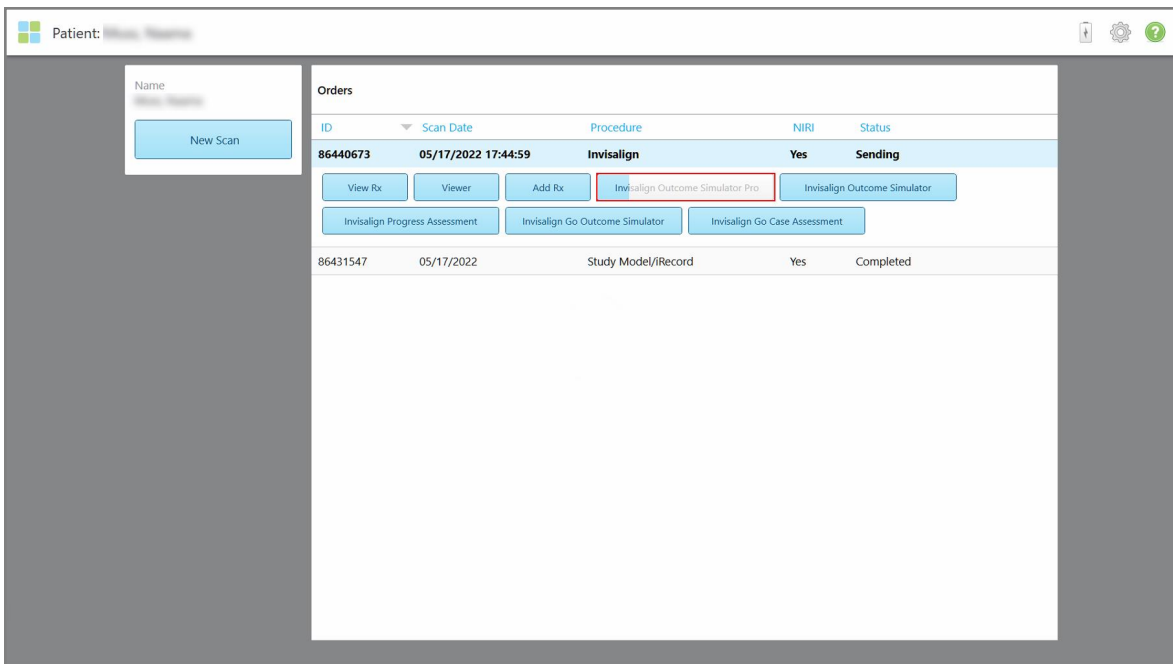

Figure 144: Invisalign Outcome Simulator Pro progress shown in the patient's profile page



If you did not select to run Invisalign Outcome Simulator Pro, a notification is displayed that the model is being sent and then the patient’s profile page is displayed showing the status of the order.

### 5.8 Working with the Viewer

The Viewer is a tool that enables you to view and manipulate the digital model for case presentations. Only scans that have already been sent can be viewed in the Viewer.

The Viewer can be accessed from Past Orders in the *Orders* page, or from a specific patient’s profile page.

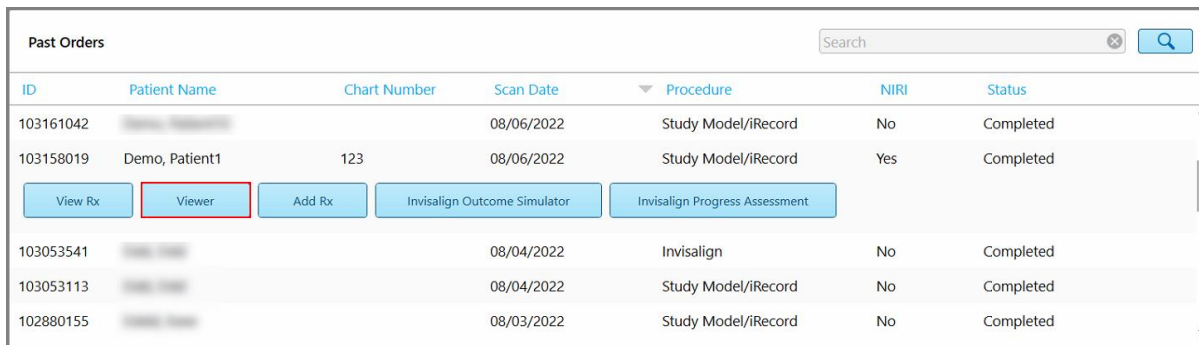

Figure 145: Viewer option in the Past Orders pane in the Orders page

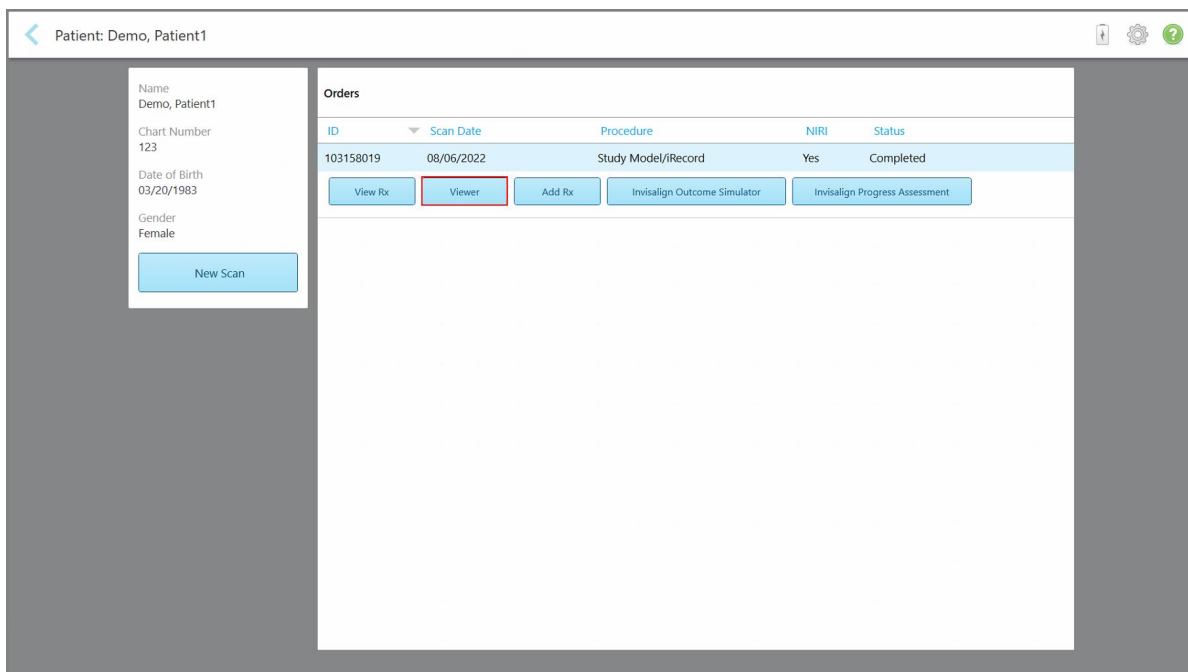

Figure 146: Viewer option in the patient’s profile page

**Note:** The NIRI column in the *Orders* page and the patient's profile page is not displayed for iTero Element 5D Plus Lite systems.

In the Viewer, you can tap the following to:



Show/hide the upper jaw.



Show/hide the lower jaw.



Show both jaws.



Open the Review tool to view an area of interest as both NIRI and color images, one below the other, as described in [Working with the Review tool \(iTerо Element 5D and 5D Plus\)](#).

**Note:** The Review tool is displayed only for cases that were scanned with NIRI enabled.



Display the Invisalign Outcome Simulator Pro tool, as described in [Invisalign Outcome Simulator Pro](#). Available only for Study Model/iRecord procedures and Invisalign Aligners procedure types.



Display the model in a 1-window view, with the upper and lower jaws in the same window (Frontal view).



Figure 147: Model in a 1-window view

Relevant for Orthodontic procedures only.



Display the model in a 2-window view, with the upper and lower jaws in separate windows (Occlusal view). Each model can be controlled separately, for better evaluation.



Figure 148: Model in a 2-window view

Relevant for Orthodontic procedures only.



Display the model in a 5-window view, with the upper and lower jaws separately, and both jaws from the left, center, and right (Gallery view). Each model can be controlled separately, for better evaluation.



Figure 149: Model in a 5-window view

Relevant for Orthodontic procedures only.



Display/hide the margin line of the prepped tooth.

Relevant for Restorative procedures only.



Show/hide the ditch created by the Modeling team. This will be enabled in the Viewer only after the modeling phase.

Relevant for Restorative procedures only.



Toggle between viewing the model in color or monochrome.



Show/hide the occlusal clearance between the opposing teeth, as described in [Working with the Occlusal Clearance tool](#). This option is enabled only if the bite was scanned.

**Note:** When the case status is **iTerо Modeling**, it is in the early stages of modeling, and the margin line and die tools are disabled.

When the modeling process is completed, and the die and margin line have been edited, the changes appear in color on the model and the tools are displayed in color, indicating that they are active.

## 5.9 Removing the wand sleeve

The wand sleeves are intended for single-patient use and must be disposed of and replaced after each patient in order to avoid cross-contamination.

**To remove the wand sleeve:**

1. Once the scan is complete, or if the scan has been interrupted, press lightly on the center of the sleeve, slowly pull the sleeve off the wand, and discard it.

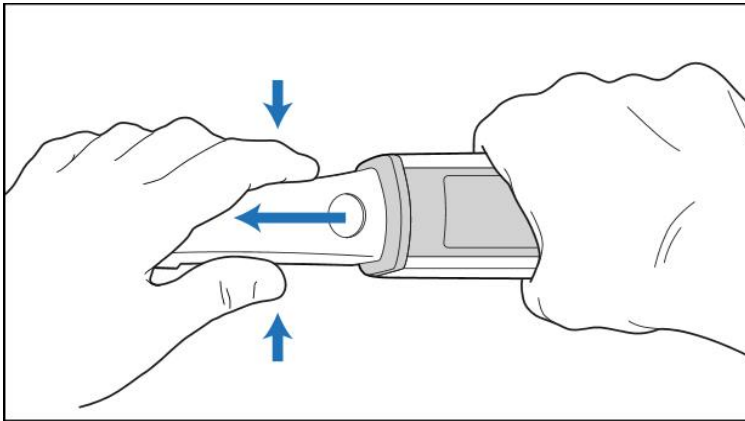

Figure 150: Removing a wand sleeve



**CAUTION:** Dispose of used sleeves according to standard operating procedures or local regulations for the disposal of contaminated medical waste.

**CAUTION: OPTICAL SURFACE!**

DO NOT touch the optical surface of the wand. Contact may cause damage. If additional cleaning, besides that listed in [Wand cleaning and disinfection](#) is necessary, use the anti-static cloth found inside the sleeve box. For more information, refer to the instructions in the box.

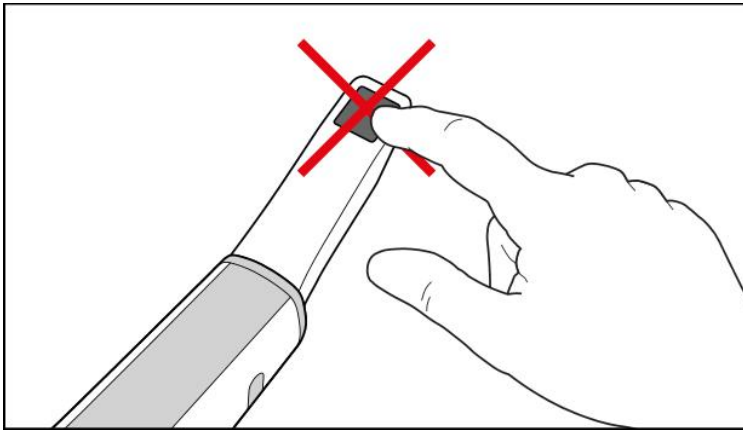

Figure 151: Optical surface of the wand

2. Clean and disinfect the wand, as described in [Cleaning and disinfecting the wand](#).
3. Gently slide a new sleeve onto the tip of the wand until it clicks into place.

**Note:** If the scanner will not be used immediately after cleaning and disinfection, attach the blue protective sleeve.

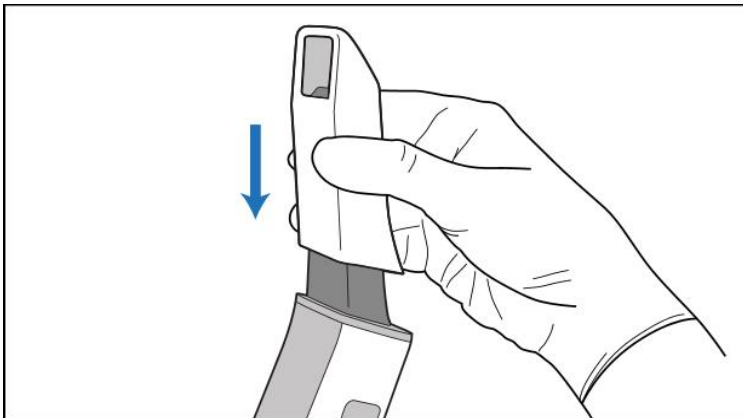

Figure 152: Gently slide the new sleeve into place

## 6 Working with patients

On the home screen, tap the **Patients** button to display the *Patients* page.



The *Patients* page displays a list of all patients registered in your iTerO system, and if relevant, their chart number, date of birth, and the date of their last scan.

Patient Name	Chart Number	Date of Birth	Last Scan Date
[Redacted]			08/04/2022
[Redacted]			08/03/2022
[Redacted]			07/31/2022
[Redacted]			07/26/2022
[Redacted]			07/25/2022
[Redacted]			07/21/2022
[Redacted]			07/19/2022
[Redacted]			06/22/2022
[Redacted]			02/15/2022
[Redacted]			01/26/2022
[Redacted]			11/16/2021
[Redacted]			11/09/2021
[Redacted]	12345	[Redacted]	05/27/2021
[Redacted]			04/29/2021
[Redacted]			04/29/2021
[Redacted]			02/07/2021

Figure 153: Patients page

Once you have selected a patient, you can view the patient's profile page with the patient's details.

### 6.1 Searching for patients

If required, you can search for patients in the iTerO database using their names or chart numbers.

**To search for a patient:**

- In the *Patients* page, enter the patient’s name or chart number (or part thereof) in the search field and then tap the search button .

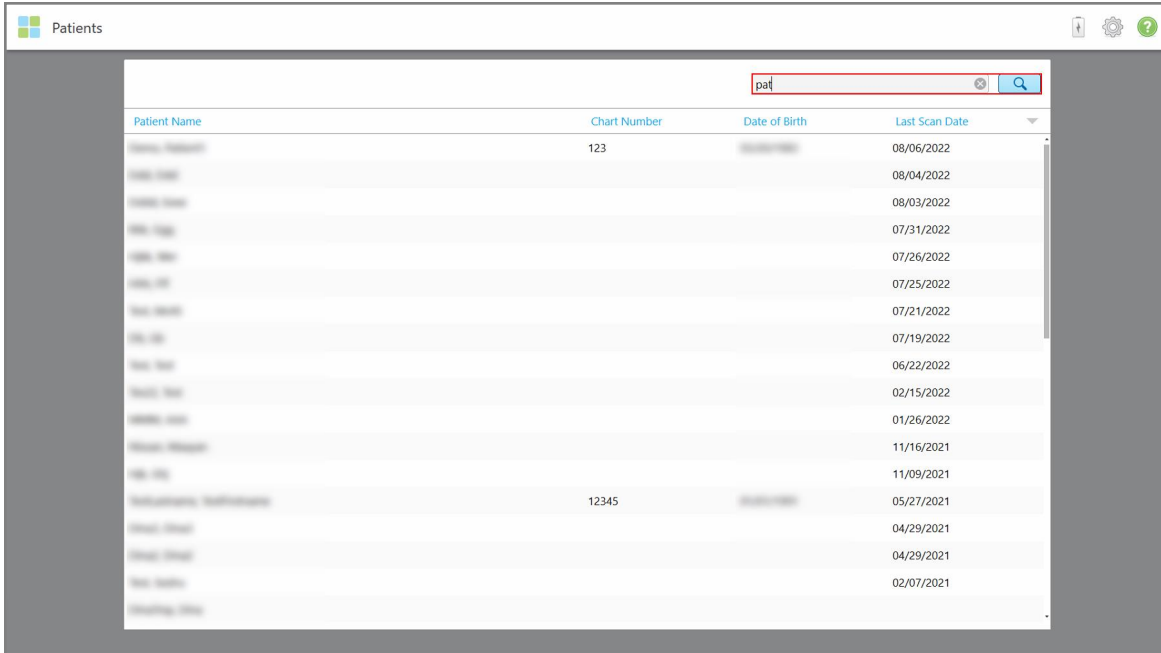

**Figure 154: Searching for a patient**

The patients that match the search criteria are displayed.

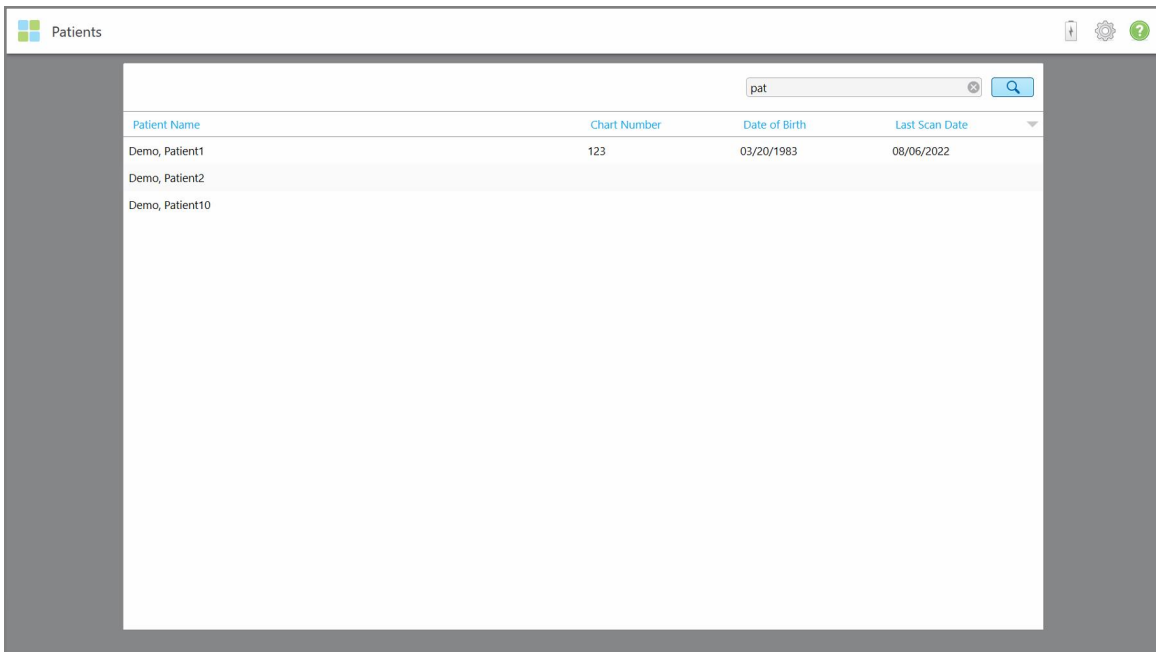

**Figure 155: Patients matching the search criteria are displayed**

## 6.2 Viewing the patient details

You can view the patient's details, including all the patient's previous scans, in the patient's profile page.

### To view the patient details:

1. Tap the **Patients** button on the home screen.

The *Patients* page is displayed, showing a list of patients, their chart number, and the date of their last scan.

2. Select the required patient in the list.

The selected patient's profile page is displayed:

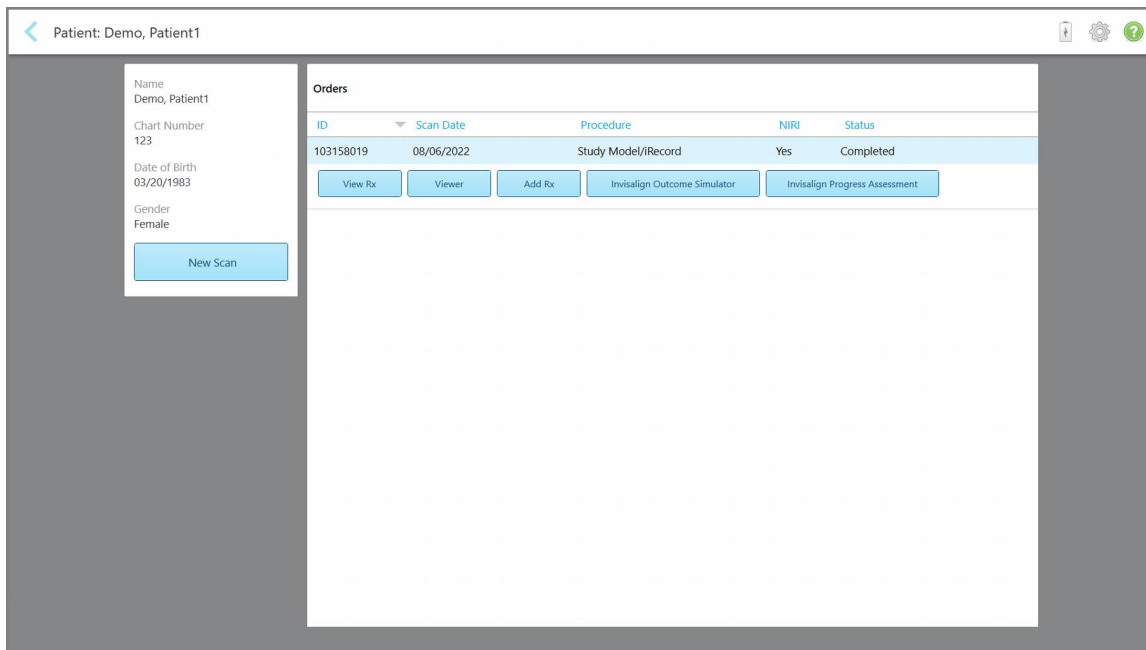

Figure 156: Patient's profile page

**Note:** The **NIRI** column is not displayed for iTerio Element 5D Plus Lite systems.

From the patient's profile page, you can:

- Create a new scan for the specific patient, described in [Creating a new scan for a specific patient](#)
- View the Rx details and edit the patient's details, described in [Viewing the Rx](#)
- View the patient's previous scans in the Viewer, described in [Viewing previous scans in the Viewer](#)
- Compare 2 previous scans using iTerio TimeLapse technology, described in [Comparing previous scans using iTerio TimeLapse technology](#)
- View any Invisalign-related processes



### 6.3 Creating a new scan for a specific patient

If required, you can create a new scan for a specific patient. The Rx opens with the patient's details already filled in.

**To create a new scan for a specific patient:**

1. In the patient's profile page, tap **New Scan**.

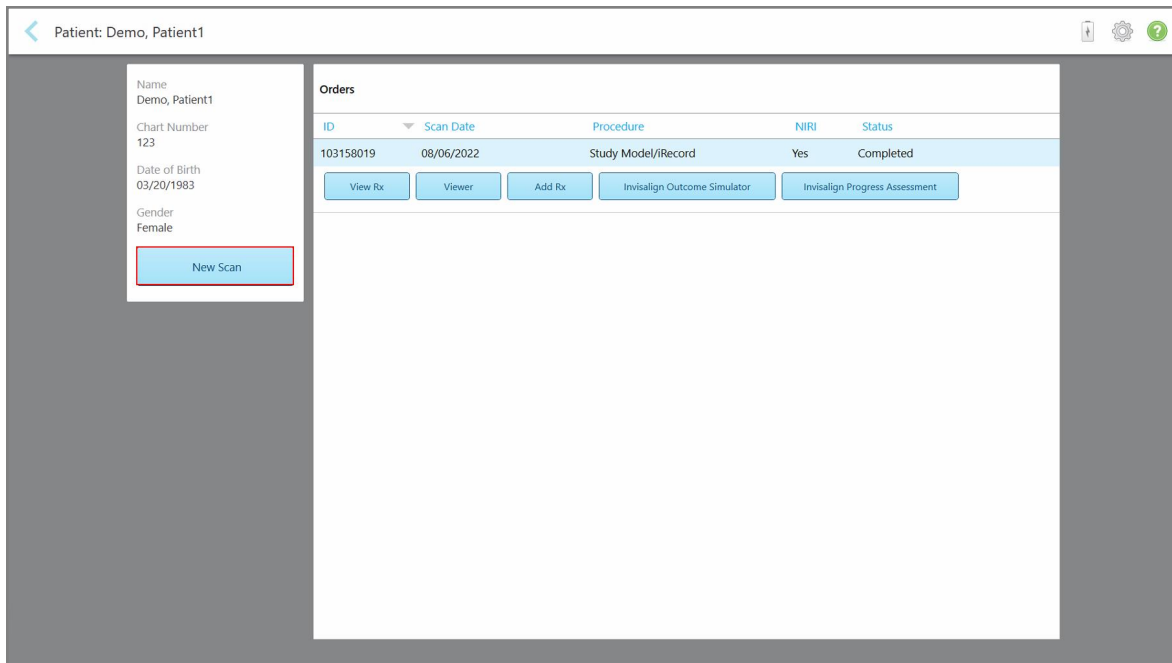

Figure 157: Patient's profile page – New Scan option

**Note:** The NIRI column is not displayed for iTero Element 5D Plus Lite systems.

The *New Scan* window is displayed, with the patient's details already filled in.

The screenshot shows the 'New Scan' window with the following details filled in:

- Doctor: Dr. Demo, Demo
- License: 12345
- Patient: Patient1, Demo, 20/03/1983, 123, Female
- Order: Procedure, Type, Due Date, Send to
- Scan Options: NIRI Capture (checked), New Sleeve Attached (unchecked)
- Notes: Add Note

Figure 158: New Scan window with patient's details already filled in

2. Fill in the rest of the Rx details according to the new requirements.

## 6.4 Viewing the Rx

If required, you can view the Rx of a previous order.

**To view the Rx of a previous order:**

1. In the patient's profile page, select the order for which to view the Rx and then tap **View Rx**.

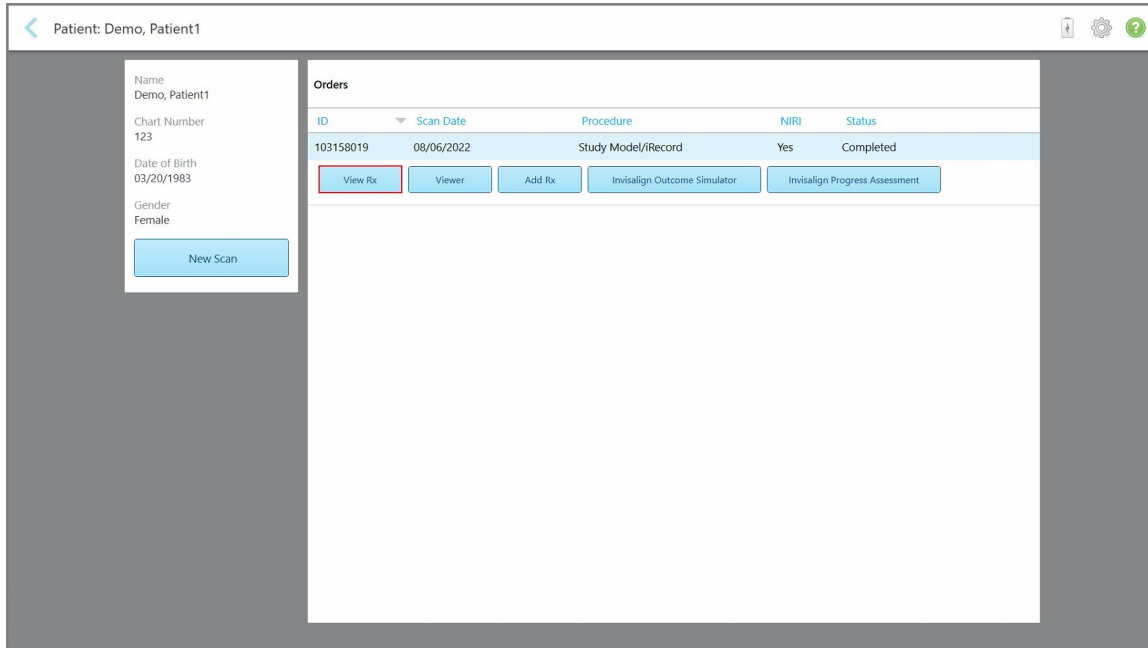

Figure 159: Patient's profile page – View Rx option

**Note:** The **NIRI** column is not displayed for iTero Element 5D Plus Lite systems.

The *Rx Details* window is displayed.

The screenshot shows the 'Rx Details' window with the following content:

- Header: Rx Details
- Read-only notice: This Form is Read-only.
- Doctor: Dr. Demo, Demo; License: 12345
- Patient section:
  - First Name: Patient1; Last Name: Demo
  - Date of Birth: 20/03/1983; Gender:  Male  Female
  - Chart Number: 123
- Order section:
  - Notice: All Study Model/iRecord scans are available for Invisalign.
  - Procedure: Study Model/iRecord; Ortho Model/iCast:
  - Due Date: ; Send to:
- Scan Options section:
  - NIRI Capture:
  - Multi-Bite:
  - New Sleeve Attached:
- Notes section: (Empty)

Figure 160: Rx Details window

2. Tap  to return to the patient's profile page.

## 6.5 Viewing previous scans in the Viewer

If required, you can display previous scans in the Viewer.

**To view a previous scan in the Viewer:**

1. In the patient's profile page, tap the scan you want to display in the Viewer and then tap **Viewer**.

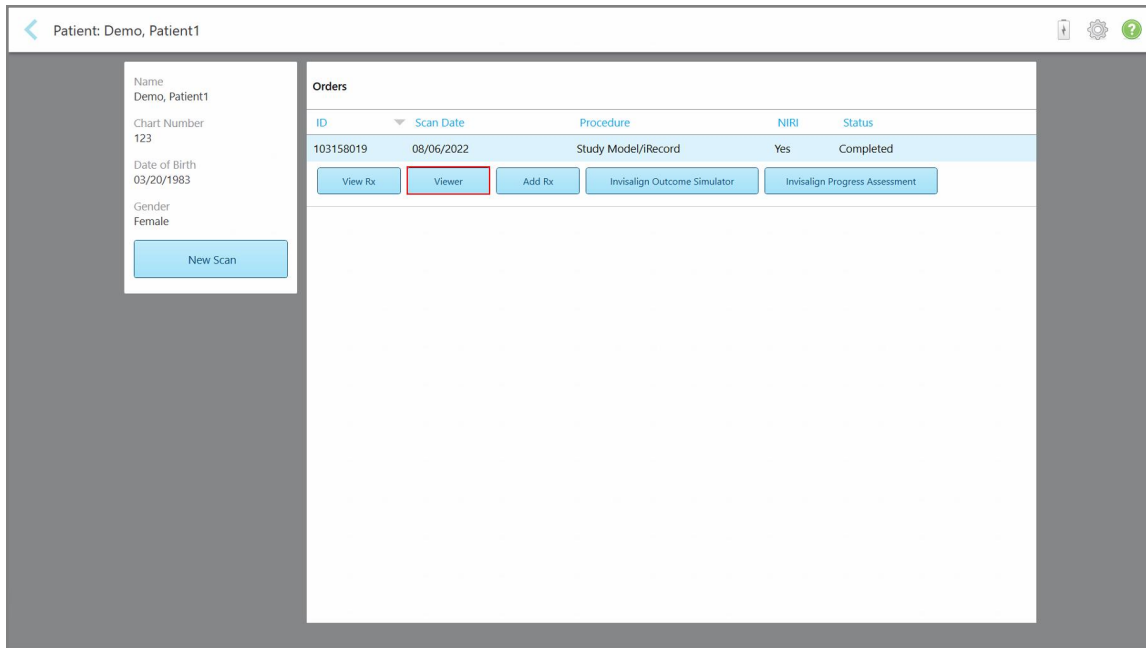

Figure 161: Patient's profile page – Viewer option

The scan is displayed in the Viewer.

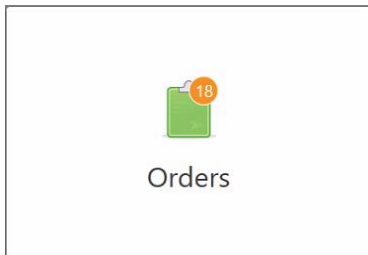

Figure 162: Scan displayed in the Viewer

For more information on working with the Viewer, see [Working with the Viewer](#).

## 7 Working with orders

Tap the **Orders** button to display a list of all your orders. The button may contain a badge that indicates the number of orders that have not been submitted yet.



If an order has been returned from the lab, the button is displayed in red, with an alarm icon badge, as described in [Working with orders](#).

The *Orders* page is made up of two panes listing the orders that are still in progress and the ones that have already been submitted.

You can view the following details for each order: the order ID, patient's name, chart number, the scan date, procedure, whether NIRI data was captured, and the status of the order.

**Note:** The **NIRI** column is not displayed for iTerо Element 5D Plus Lite systems.

The order could have one of the following statuses, depending on the procedure:

- **Rx Created:** The Rx has been filled in, but the patient has not been scanned yet.
- **Scanning:** The scan process is in progress.
- **Sending:** The scan is in the process of being sent.
- **Sent:** The scan has been sent.
- **Failed to Send:** The scan was not sent.
- **iTerо Modeling:** The scan has been sent to iTerо Modeling.
- **Ortho Modeling:** The scan has been sent for modeling.
- **Lab Review:** The scan has been sent to the lab for review.
- **Returned:** The scan was rejected by the lab and has been sent back for rescanning or other adjustments, as described in [Working with orders](#).
- **Align Production:** The scan is undergoing an internal process.
- **Exporting to Doctor Site:** The scan is on the way to the IDS portal.
- **Completed:** The flow has been completed.

The screenshot shows the 'Orders' page with two main sections: 'In Progress' and 'Past Orders'. The 'In Progress' section contains a table with columns: ID, Patient Name, Chart Number, Scan Date, Procedure, NIRI, and Status. The 'Past Orders' section contains a similar table with a search bar above it.

In Progress						
ID	Patient Name	Chart Number	Scan Date	Procedure	NIRI	Status
	Demo, Patient1	123	08/06/2022 08:20:10	Appliance	Yes	Rx Created
	Demo, Patient1			Appliance	Yes	Scanning
	Demo, Patient1			Denture/Removable	Yes	Rx Created
	Demo, Patient1			Denture/Removable	Yes	Rx Created
	Demo, Patient1			Fixed Restorative	Yes	Rx Created
	Demo, Patient1			Invisalign	No	Rx Created
	Demo, Patient1			Invisalign	Yes	Rx Created
	Demo, Patient1			Invisalign	Yes	Rx Created

Past Orders						
ID	Patient Name	Chart Number	Scan Date	Procedure	NIRI	Status
103161042	Demo, Patient1		08/06/2022	Study Model/iRecord	No	Completed
103158019	Demo, Patient1	123	08/06/2022	Study Model/iRecord	Yes	Completed
103053541	Demo, Patient1		08/04/2022	Invisalign	No	Completed
103053113	Demo, Patient1		08/04/2022	Study Model/iRecord	No	Completed
102880155	Demo, Patient1		08/03/2022	Study Model/iRecord	No	Completed
102618280	Demo, Patient1		07/31/2022	Denture/Removable	Yes	Completed
102615884	Demo, Patient1		07/31/2022	Fixed Restorative	Yes	Completed

Figure 163: Orders page

**To view or review orders:**

1. Tap the **Orders** button on the home screen.

The *Orders* page is displayed, showing two panes – **In Progress** orders and **Past Orders**.

- **In Progress:** Scans that have not yet been submitted.
- **Past Orders:** Scans that have already been submitted.

2. Tap on an order in the **In Progress** pane to view the following options:

The screenshot shows the 'In Progress' pane with a table of orders. The first row is highlighted with a red border, and below it are three buttons: 'View Rx', 'Scan', and 'View Scans', along with a 'Delete' button.

ID	Patient Name	Chart Number	Scan Date	Procedure	NIRI	Status
	Demo, Patient1		08/29/2022 12:51:12	Appliance	Yes	Scanning
	Demo, Patient1		08/29/2022 12:49:35	Appliance	No	Scanning
	Demo, Patient1		08/13/2022 03:59:18	Fixed Restorative	Yes	Scanning
	Demo, Patient1		08/12/2022 07:19:44	Fixed Restorative	Yes	Scanning
	Demo, Patient1		08/12/2022 04:11:50	Study Model/iRecord	Yes	Scanning
	Demo, Patient1		08/12/2022 04:01:13	Fixed Restorative	Yes	Scanning

Past Orders						
ID	Patient Name	Chart Number	Scan Date	Procedure	NIRI	Status
103479301	Demo, Patient1		08/10/2022	Appliance	Yes	Completed
103452284	Demo, Patient1		08/10/2022	Denture/Removable	Yes	Completed
103446627	Demo, Patient1		08/10/2022	Study Model/iRecord	Yes	Completed
103164334	Demo, Patient1	123	08/06/2022	Invisalign	Yes	Completed
103161042	Demo, Patient1		08/06/2022	Study Model/iRecord	No	Completed
103158019	Demo, Patient1	123	08/06/2022	Study Model/iRecord	Yes	Completed
103053541	Demo, Patient1		08/04/2022	Invisalign	No	Completed

Figure 164: In Progress pane – options

- **View Rx:** Opens the *Rx Details* window, enabling you to view the prescription for this order.
  - **Scan:** Opens the *Scan* window, enabling you to create a new scan or continue scanning the patient.
  - **View Scans:** Opens the *View* window, enabling you to review the current scan.
3. Tap an order in the **Past Orders** pane to view the following options, depending on the procedure:

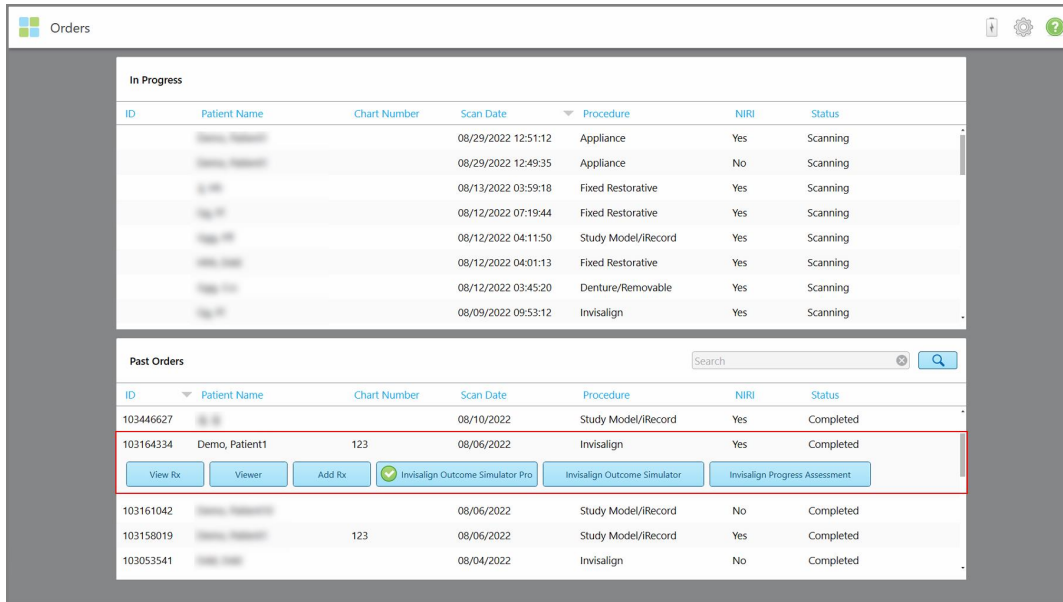

Figure 165: Past Orders pane – options

- **View Rx:** Opens the *Rx Details* window, enabling you to view the prescription for this order.
- **Viewer:** Opens the *Viewer* window, enabling you to view and manipulate the model. For more information on working with the Viewer, see [Working with the Viewer](#).
- **Add Rx:** Opens the *New Scan* window and enables you to add a prescription for this order.  
**Note:** This is applicable for Orthodontic orders only, and available for up to 21 days after the scan.
- Invisalign users can also select the following Invisalign features:
  - [Invisalign Outcome Simulator Pro](#)
  - [Invisalign Outcome Simulator](#)
  - [Invisalign Progress Assessment](#)
  - [Invisalign Go system](#)
  - [Invisalign Go system](#)



## 7.1 Working with returned orders

Labs can return orders within 30 days if the scan is incomplete and needs to be rescanned, for example, if there are missing scans, bite issues, or if the margin line is not clear. If the lab returns an order, the **Orders** button is highlighted in red with an alarm icon badge.

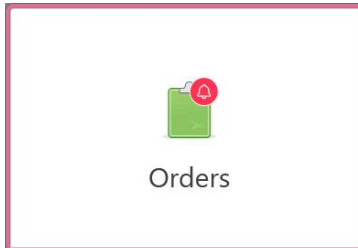

Figure 166: Orders button notifying a returned order

The returned order is displayed at the top of the **In Progress** pane, with the status **Returned**, in red.

 The screenshot shows the "Orders" application window. At the top left, there is a logo and the word "Orders". At the top right, there are icons for a list, settings, and help. The main content area is divided into two sections: "In Progress" and "Past Orders". The "In Progress" section contains a table with columns: ID, Patient Name, Chart Number, Scan Date, Procedure, NIRI, and Status. The first row is highlighted with a red border and has the status "Returned" in red text. The "Past Orders" section contains a search bar and a table with the same columns as the "In Progress" section, showing several completed orders.
 

ID	Patient Name	Chart Number	Scan Date	Procedure	NIRI	Status
103181639	Demo, Patient1	123	08/07/2022 00:52:32	Appliance	Yes	Returned
		12345		Invisalign	Yes	Rx Created
				Invisalign	Yes	Rx Created
				Invisalign	Yes	Rx Created
				Invisalign	Yes	Rx Created
				Study Model/iRecord	Yes	Rx Created
				Invisalign	Yes	Rx Created
				Study Model/iRecord	Yes	Rx Created

ID	Patient Name	Chart Number	Scan Date	Procedure	NIRI	Status
102880155			08/03/2022	Study Model/iRecord	No	Completed
103053113			08/04/2022	Study Model/iRecord	No	Completed
103158019		123	08/06/2022	Study Model/iRecord	Yes	Completed
103161042			08/06/2022	Study Model/iRecord	No	Completed
102036203			07/24/2022	Appliance	No	Completed
102180850			07/26/2022	Invisalign	Yes	Completed
99976922			06/28/2022	Invisalign	Yes	Completed

Figure 167: Returned order in the In Progress pane

### To fix a returned order:

1. Open the returned order and fix the scan according to the lab's instructions in the **Notes** area of the Rx.
2. Return the order to the lab.

## 8 Viewing messages

The **Messages** page displays notifications, updates, and other system messages from Align Technology, for example, product updates, upcoming educational sessions, or internet connectivity issues.

If relevant, you can view the number of new or unread messages on the badge on the **Messages** button.

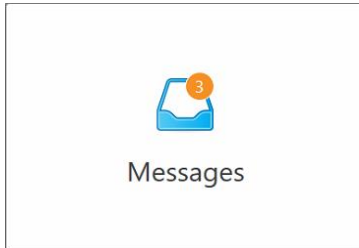

### To view the messages:

1. Tap the **Messages** button on the home screen.

A list of notifications, updates, and other messages from Align Technology is displayed.

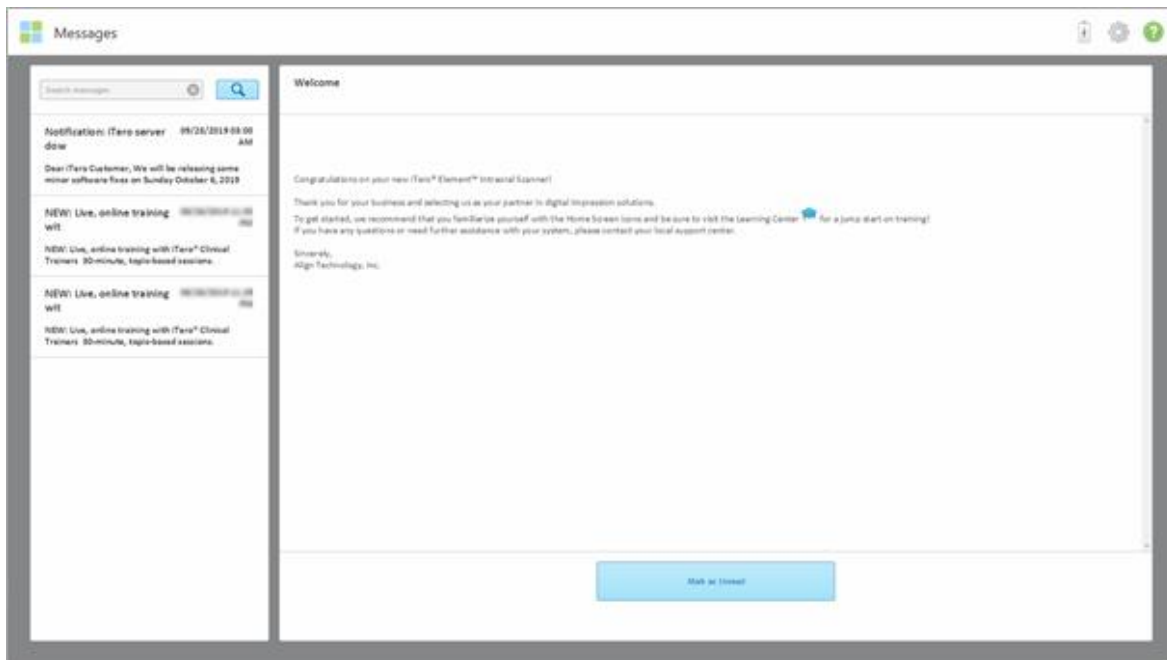

Figure 168: Messages page

2. In the left pane, quickly search for a specific message by subject title or scroll down the pane to find a specific message.
3. To mark any message as unread, tap **Mark as Unread**.

## 9 Working with MyiTero

MyiTero is a web-based portal, with the same look-and-feel as the iTero software. It enables users to carry out administrative tasks such as filling in a new Rx on any supported device, for example, a PC or a tablet, without using valuable scanner time. In addition, it enables viewing 3D models after they have been created by the scanner, and tracking orders.

## 10 iTero scanner features and tools

This section describes the following iTero scanner features and tools:

- [Comparing previous scans using iTero TimeLapse technology](#)
- [Invisalign Outcome Simulator Pro](#)
- [Invisalign Outcome Simulator](#)
- [Invisalign Progress Assessment](#)
- [Invisalign Go system](#)
- [Editing tools](#)
  - [Deleting a segment](#)
  - [Deleting a selection](#)
  - [Filling in missing anatomy](#)
  - [Disabling auto-cleanup](#)
- Scan tools:
  - [Working with the Eraser tool](#)
  - [Working with the Occlusal Clearance tool](#)
  - [Working with the Edge Trimming tool](#)
  - [Working with the Die Separation tool](#)
  - [Working with the Margin Line tool](#)
  - [Working with the Review tool \(iTero Element 5D and 5D Plus\)](#) and [Working with the Review tool \(iTero Element 5D Plus Lite\)](#)
  - [Working with the Snapshot tool](#)

### 10.1 Comparing previous scans using iTero TimeLapse technology

Patients who are scanned regularly can have their scans analyzed using iTero TimeLapse technology.

iTero TimeLapse technology compares 2 of the patient's previously captured 3D scans to allow visualization of the changes in the patient's teeth, tooth structure, and oral soft tissues over the period between the scans. For example, iTero TimeLapse technology can display tooth wear, gingival recession, and tooth movement over the relevant period.

**Note:** iTero TimeLapse technology is available for Orthodontic procedures only.

#### To use iTero TimeLapse technology:

1. In the *Patients* page, select the patient for whom to create an iTero TimeLapse visualization.

- In the patient's profile page, select two scans to compare. You can select the scans by selecting the check boxes next to the relevant orders, or by selecting the check boxes in the **Timeline** area at the bottom of the page.

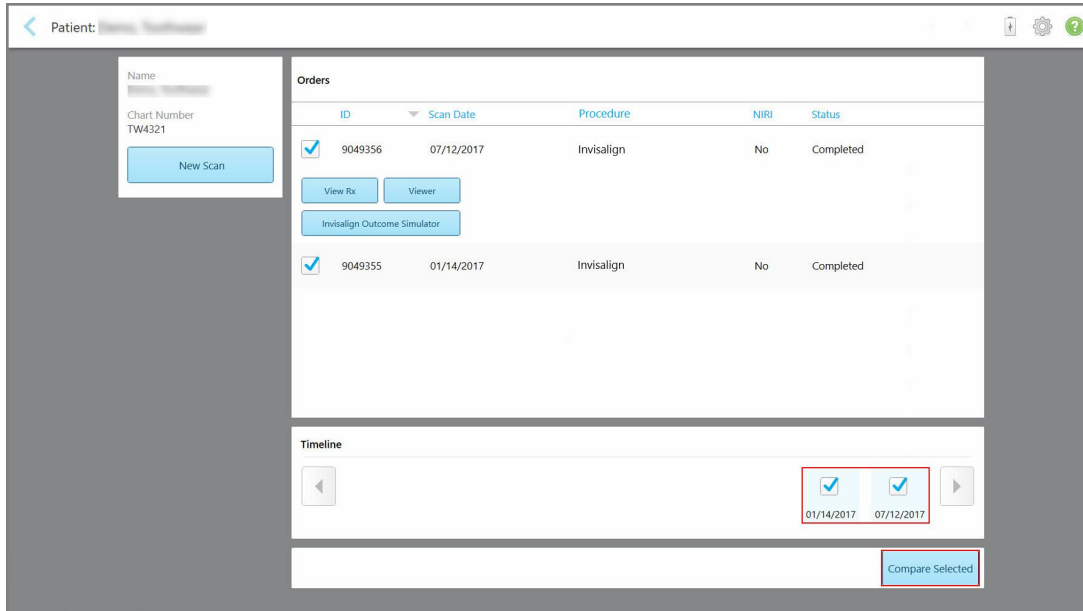

Figure 169: iTero TimeLapse – selecting the scans to compare

**Note:** The **NIRI** column is not displayed for iTero Element 5D Plus Lite systems.

- Tap the **Compare Selected** button to compare and analyze the scans.

The *iTero TimeLapse* window is displayed, highlighting the areas with changes between the scans. The darker the color, the bigger the change between the scans, as displayed in the legend.



Figure 170: iTero TimeLapse window showing the highlighted changes between the scans

**Note:** Changes are highlighted only when the scans are displayed in monochrome mode.

If required, tap  to move the scan to the default occlusal view – lower arch with anterior teeth at the bottom and upper arch with anterior teeth at the top and both arches in a frontal view like the iRecord default view.

4. Drag the loupe onto the model to view areas of interest and potential treatment areas in the animation window. An animation is displayed, comparing the state of the teeth in the current area of interest on the selected scan dates.



Figure 171: Area of interest from the first scan displayed in the animation window



Figure 172: Area of interest from the second scan displayed in the animation window

You can zoom in to the image in the animation window or tap the pause button  to pause the animation. If required, you can change the scale of the changes displayed.

- a. On the legend, tap **Scale**.

The legend is expanded to display a list of ranges:

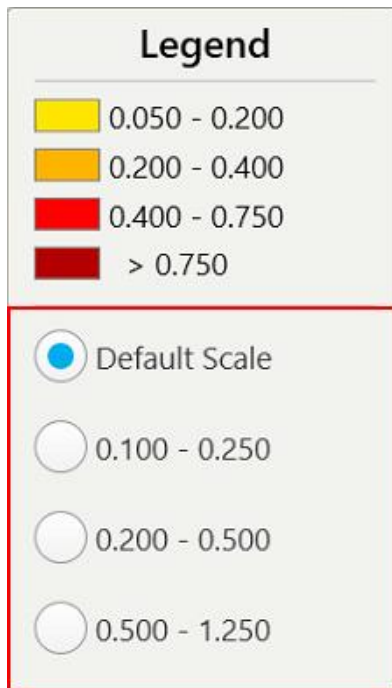



Figure 173: iTero TimeLapse scale options

- b. Select the required scale.

The changes are displayed according to the new scale.

5. If required, tap the Snapshot tool  to capture a screenshot of the images. For more information, refer to [Working with the Snapshot tool](#).

6. Tap  to exit the *iTero TimeLapse* window and then tap **Yes** to confirm exiting. The patient's profile page is displayed.

## 10.2 Invisalign Outcome Simulator Pro

Invisalign Outcome Simulator Pro is an advanced patient communication software tool that enables you to show patients the simulated outcome of their Invisalign treatment on an image of their own face. This tool provides additional information for the patient in their decision to begin Invisalign treatment.

### Notes:

- Invisalign Outcome Simulator Pro is supported on iTero Element Plus series intraoral scanners only.
- The Invisalign Outcome Simulator Pro simulation is available only for **Study Model/iRecord** procedures and **Invisalign Aligners** procedure types, and is automatically triggered when sending the scan.
- Invisalign Outcome Simulator Pro requires pairing your Invisalign Doctor Site account with your iTero account. For more information, contact iTero Customer Support.



Once the simulation is complete, you can tap  in the Viewer or the **Invisalign Outcome Simulator Pro** button in the *Orders* page, as described in [Working with orders](#).

For more information on using Invisalign Outcome Simulator Pro, refer to the Invisalign Outcome Simulator Pro documentation.

## 10.3 Invisalign Outcome Simulator

Invisalign Outcome Simulator is a software tool that enables you to show the patients the simulated outcome of their Invisalign treatment.

You can make real-time adjustments to the simulated outcome while showing the patient. This tool provides additional information for the patient in their decision to accept treatment.

To open the Invisalign Outcome Simulator tool, after sending the scan, tap **Invisalign Outcome Simulator** in the *Orders* page, as described in [Working with orders](#), or in the patient's profile page, as described in [Viewing the patient details](#).

For more information on the Invisalign Outcome Simulator tool, refer to the *Invisalign Outcome Simulator User Guide* <https://guides.itero.com>.

## 10.4 Invisalign Progress Assessment

The Progress Assessment tool includes a report that is a color-coded tooth movement table to assist the user in making treatment decisions to track the patient's progress in their ClinCheck treatment plan.

To open the Invisalign Progress Assessment tool, after sending the scan, tap **Invisalign Progress Assessment** in the *Orders* page, as described in [Working with orders](#).



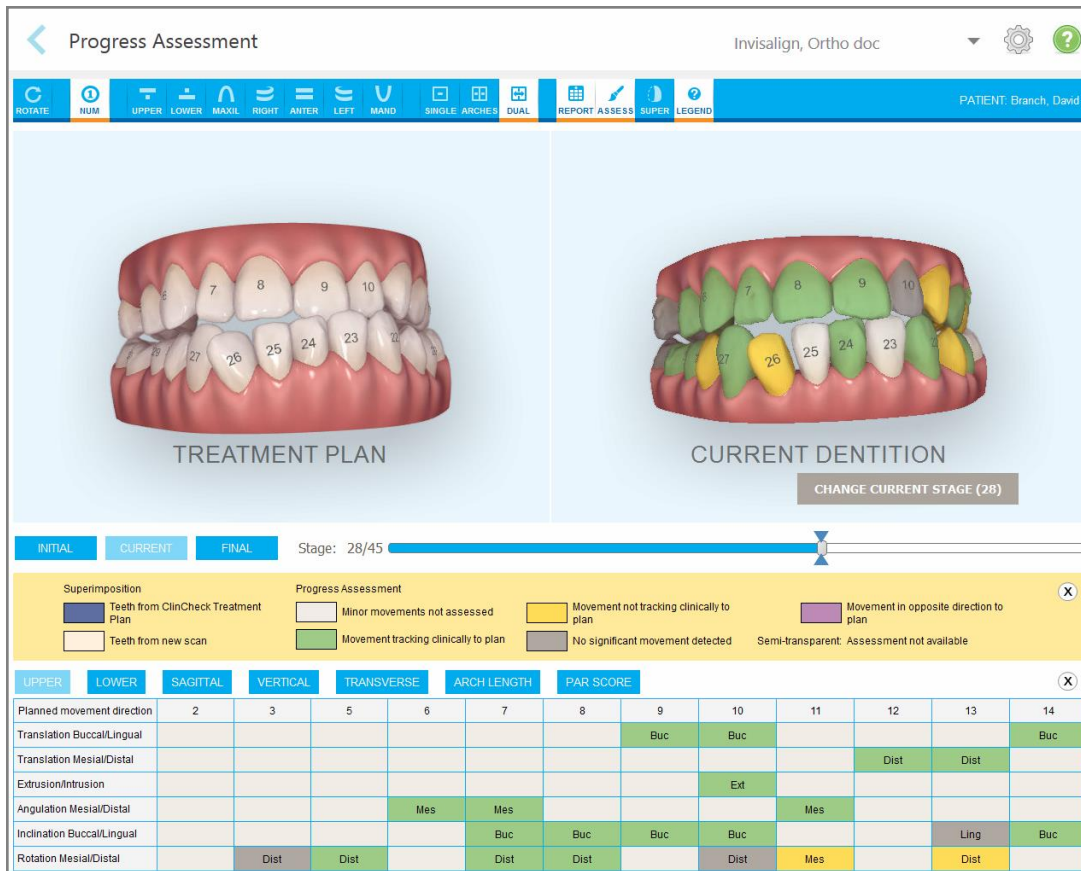

Figure 174: Progress Assessment window

For more information regarding the Invisalign Progress Assessment tool, refer to the **Progress Assessment** section in the *Invisalign Outcome Simulator User Guide* <https://guides.itero.com>.

### 10.5 Invisalign Go system

Invisalign Go is a low-stage aligner tracking product that helps you assess and treat patients in just a few taps, with guidance every step of the way.

For more information regarding the Invisalign Go System, refer to the Invisalign documentation.

### 10.6 Editing tools

After you have scanned the model, you can edit it using the following tools:

- Delete Segment tool, described in [Deleting a segment](#)
- Delete Selection tool, described in [Deleting a selection](#)
- Fill tool, described in [Filling in missing anatomy](#)
- Disable auto-cleanup tool, described in [Disabling auto-cleanup](#)

The editing tools are accessed by pressing on the screen.

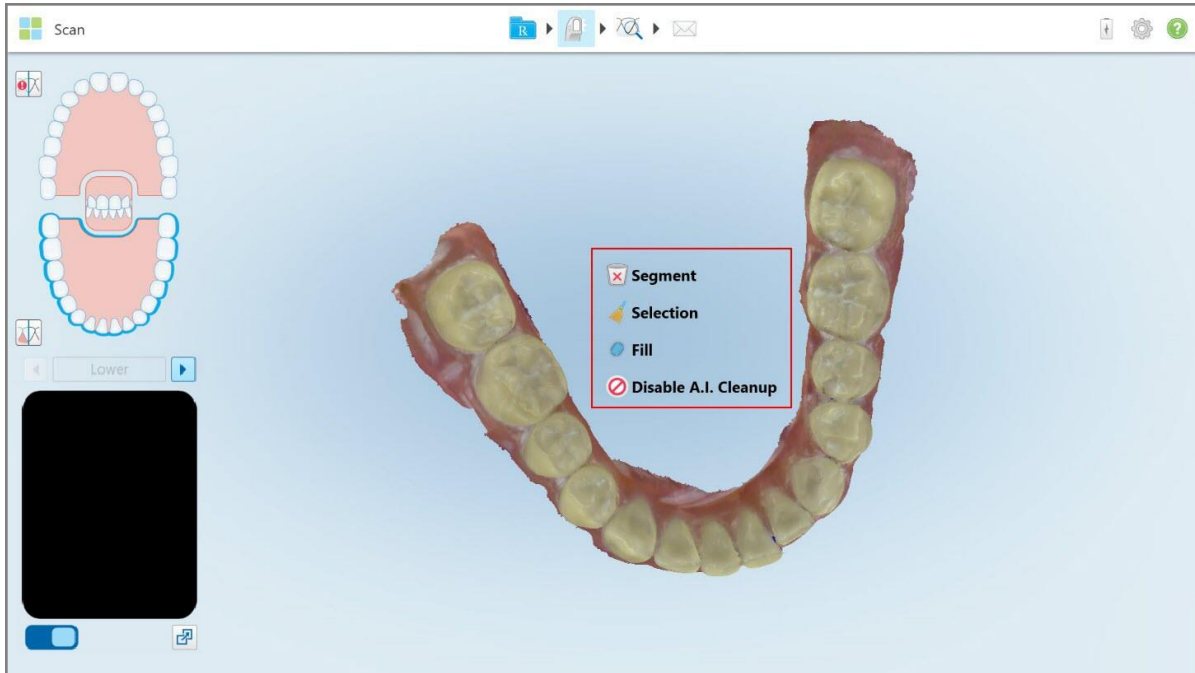

Figure 175: Editing tools

### 10.6.1 Deleting a segment

The Delete Segment tool enables you to delete the entire scanned segment.

**To delete the segment:**

1. Press the screen to display the editing tools.

2. Tap the **Delete Segment** tool .

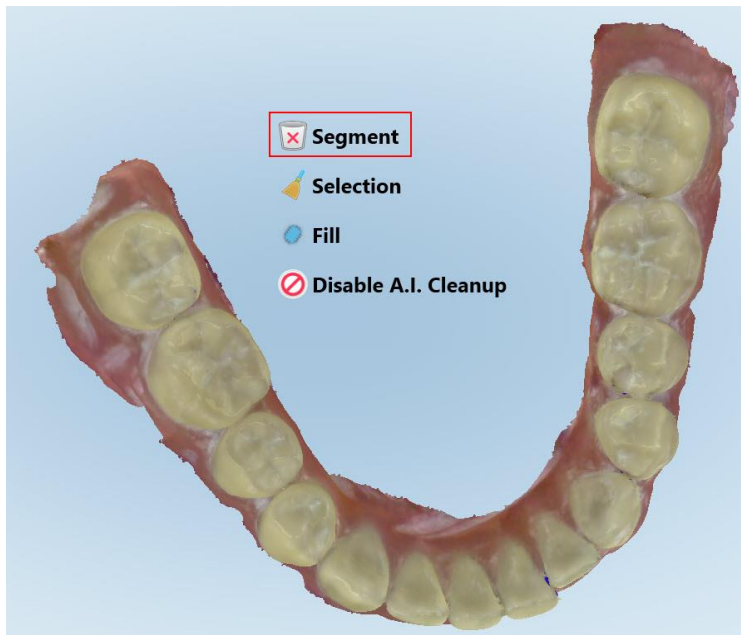



Figure 176: Delete Segment tool

A confirmation message is displayed.

3. Tap **OK** to confirm the deletion.  
The entire scanned segment is deleted.

## 10.6.2 Deleting a selection

The Delete Selection tool  enables you to delete a section of the scan so that it can be rescanned.

### To delete a selection:

1. Press the screen to display the editing tools.
2. Tap the **Delete Selection** tool .

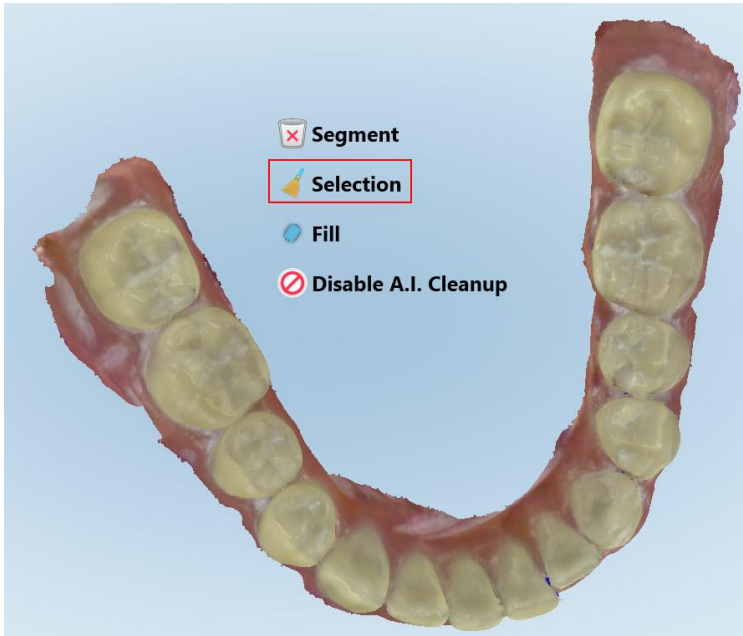

Figure 177: Delete Selection tool

The Delete Selection tool expands, and the model is displayed in monochrome.

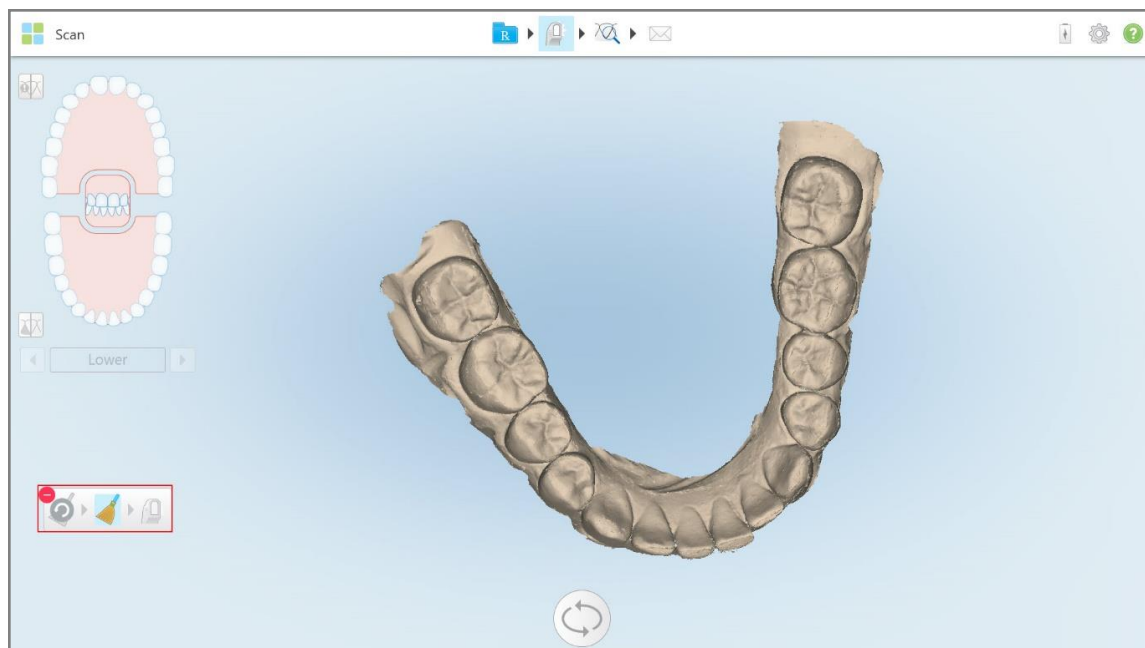

Figure 178: Expanded Delete Selection tool

3. Touch the area of the anatomy you want to delete.

The selection is removed.

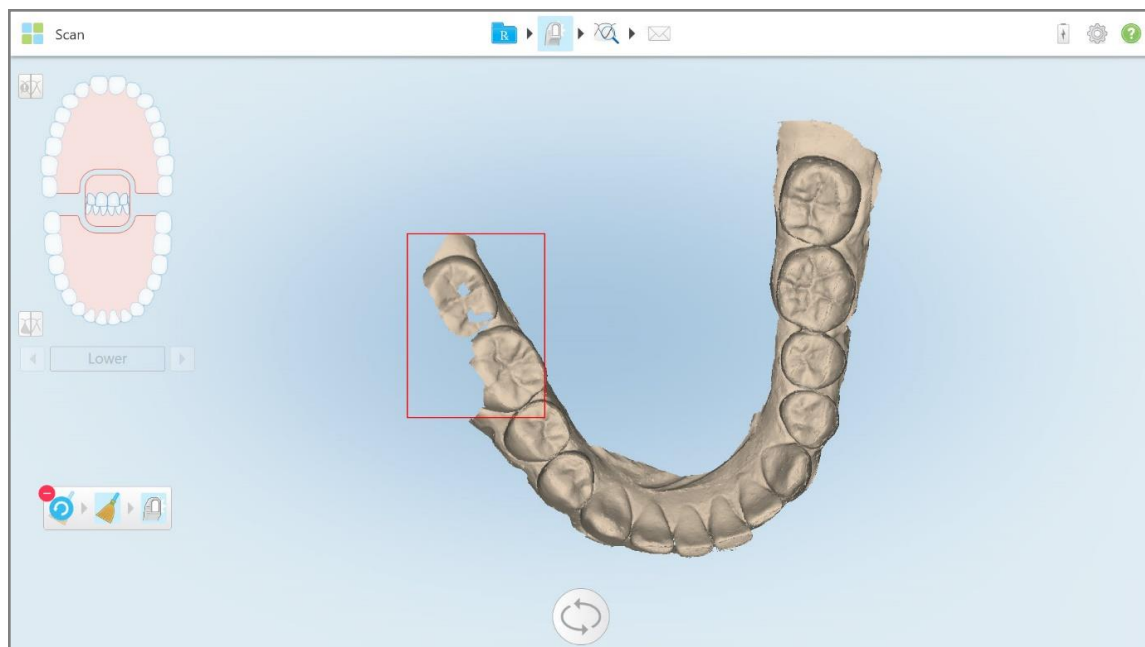





Figure 179: Selected area of the anatomy is deleted

4. If required, tap  to undo the changes.
5. Tap  to rescan the deleted anatomy.

### 10.6.3 Filling in missing anatomy

Occasionally there are areas with missing anatomy that are not filled even after trying to scan the area numerous times. These areas may be caused by the interference of anatomy (lips, cheeks, and tongue) or moisture in the scanning segment.

The Fill tool  highlights these areas and then scans only the highlighted areas, in order to prevent over-scanning.

#### To use the Fill tool:

1. Press the screen to display the editing tools.
2. Tap the **Fill** tool .

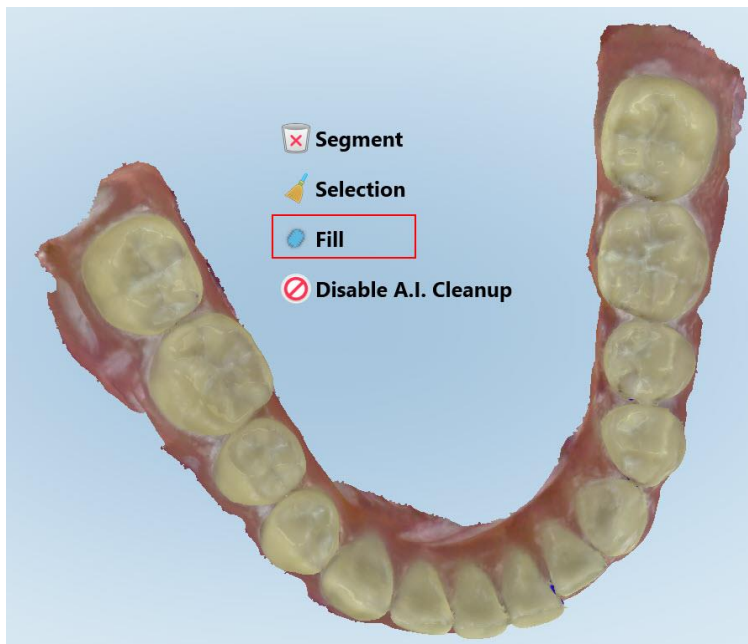

Figure 180: Fill tool

Areas that require scanning are highlighted in red.

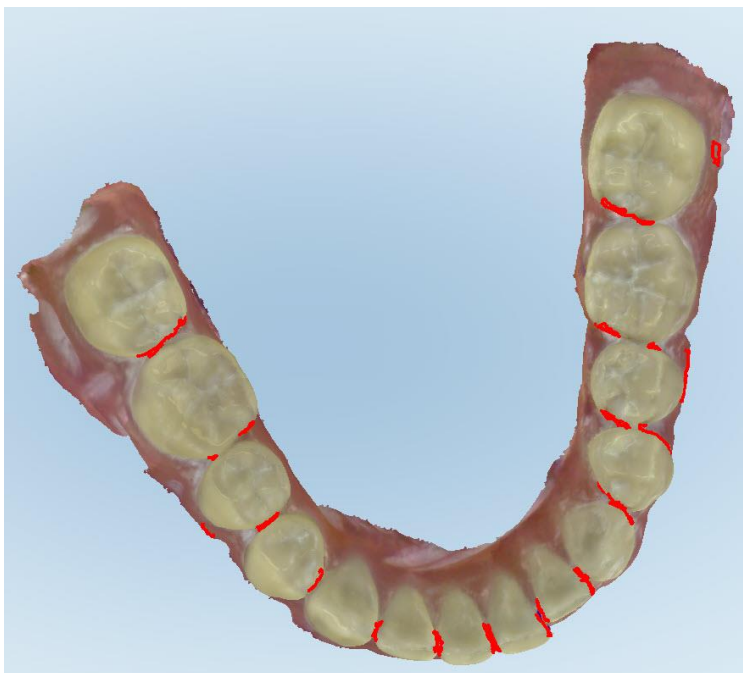

Figure 181: Areas that require scanning are highlighted in red – Fill tool

3. Rescan the patient.

In order to prevent over-scanning, only the highlighted areas are scanned, and the voids are filled.

#### 10.6.4 Disabling auto-cleanup

By default, excess tissue is removed from around the edges of the 3D model during scanning. If required, you can turn off this functionality for the current scan.

##### Notes:

- This tool is not supported for edentulous gums.
- Disabling auto-cleanup is relevant for the current scan only. Excess material will be removed by default in the next scan.

##### To disable auto-cleanup:

1. Press the screen to display the editing tools.

2. Tap the **Disable A.I. Cleanup** tool.

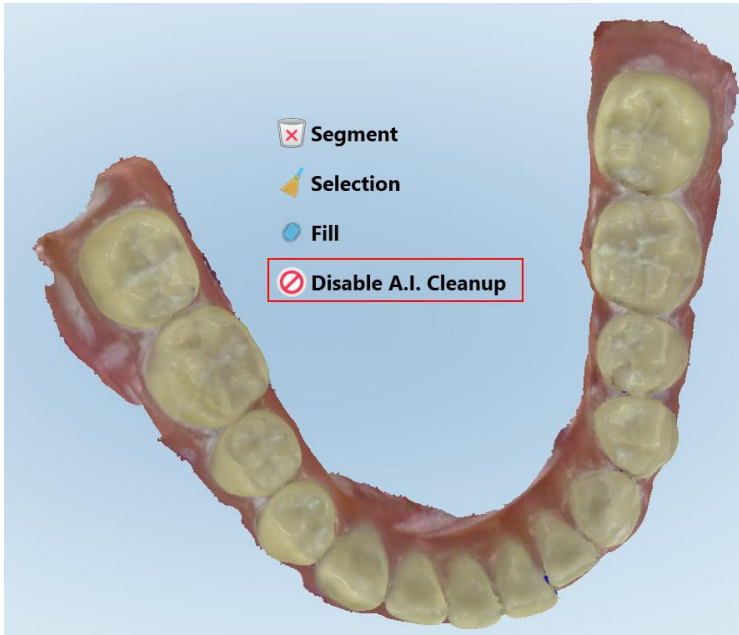

Figure 182: Auto-cleanup tool

The scan is displayed with the excess material showing.



Figure 183: Scan displayed with excess material showing

3. To return the excess tissue, press the screen to display the editing options and then tap **Enable A.I. Cleanup**.



## 10.7 Working with the Eraser tool



The Eraser tool enables you to erase a selected area of the scanned model and then rescan only the erased area.

For example:

- You can remove moisture and artifacts, such as blood or saliva, that are covering the margin.
- If the prepped tooth shows areas of red on the Occlusal Clearance legend, you can reduce the prepped tooth, erase the area on the model, and then rescan it, as described below.

### To erase part of the scan:

1. In the *View* window, ensure you are on the relevant section to be erased, and then tap the Eraser tool

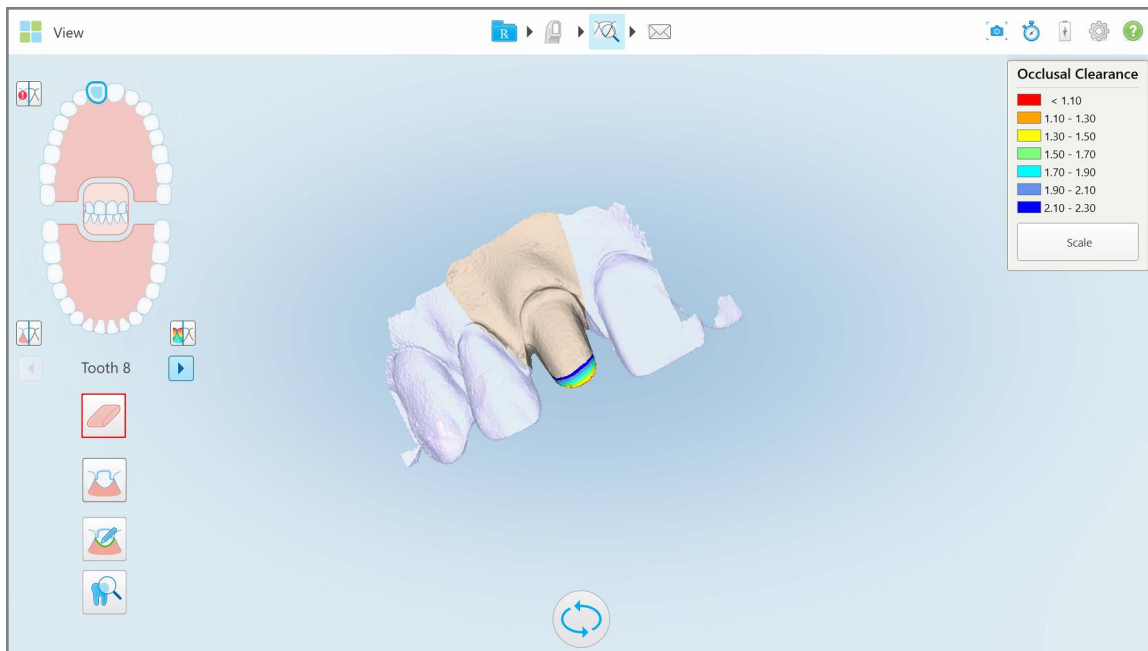

Figure 184: Eraser tool

The Eraser tool expands to show the following options:



Figure 185: Eraser tool options

2. With your finger, mark the area to be modified.

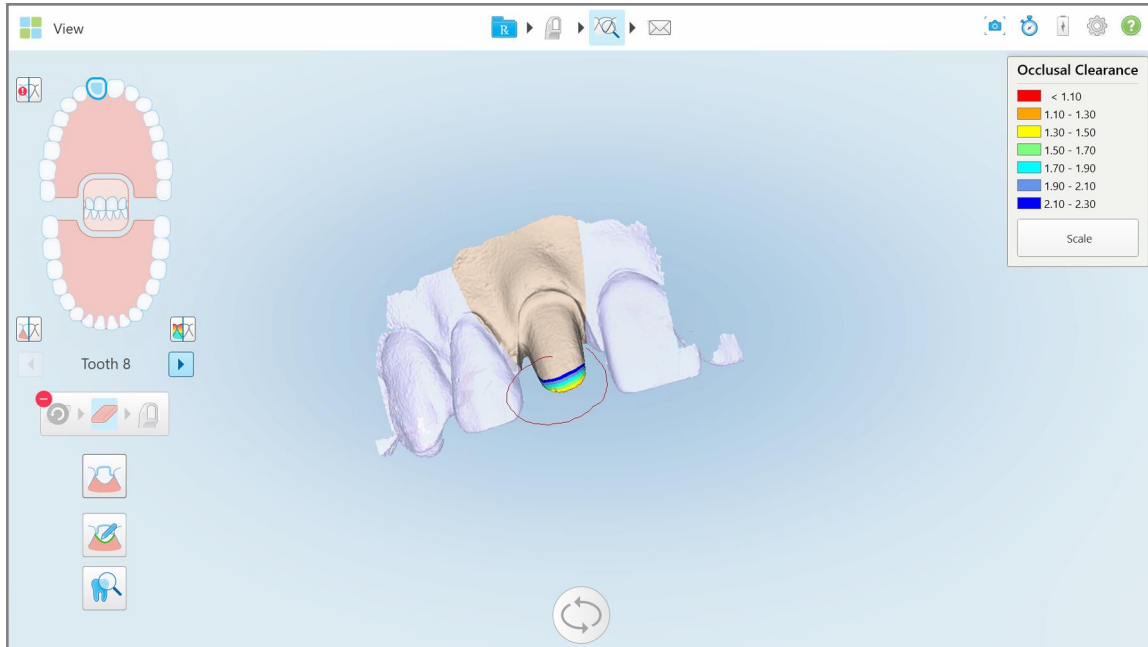



Figure 186: Mark the area to be modified

As soon as you lift your finger, the selected area is removed and the scan tool  is enabled.

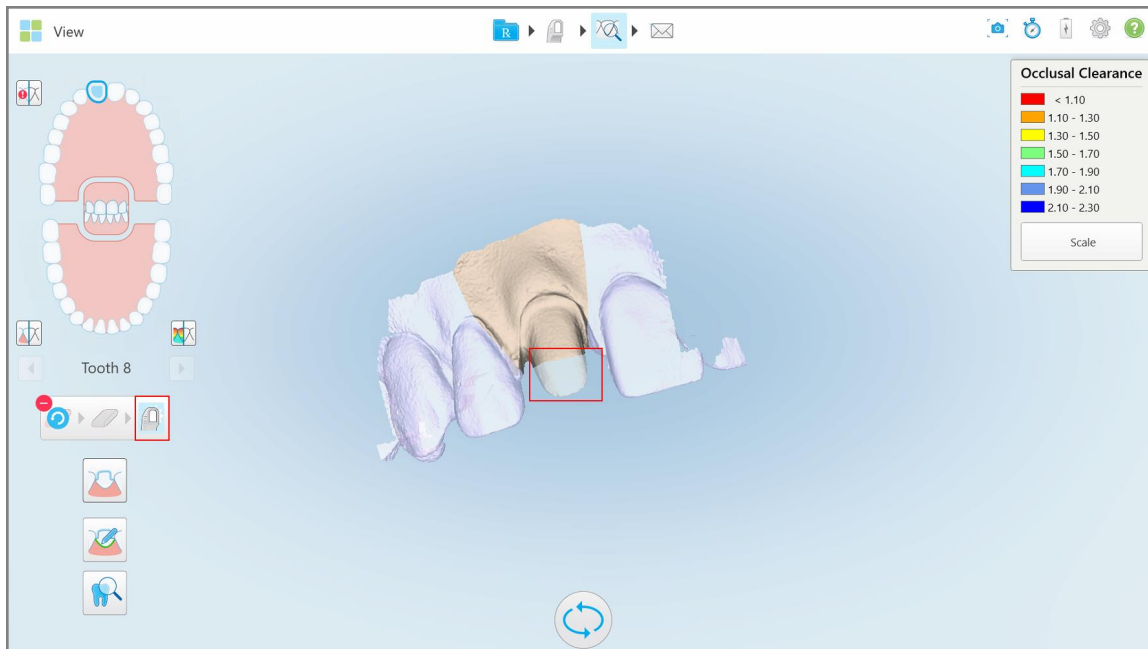



Figure 187: Selected area removed, and scan tool enabled

3. If required, tap  to undo the deletion.
4. After adjusting the clearance on the patient's tooth, tap  to return to Scan mode and rescan the deleted area, which is marked in red.

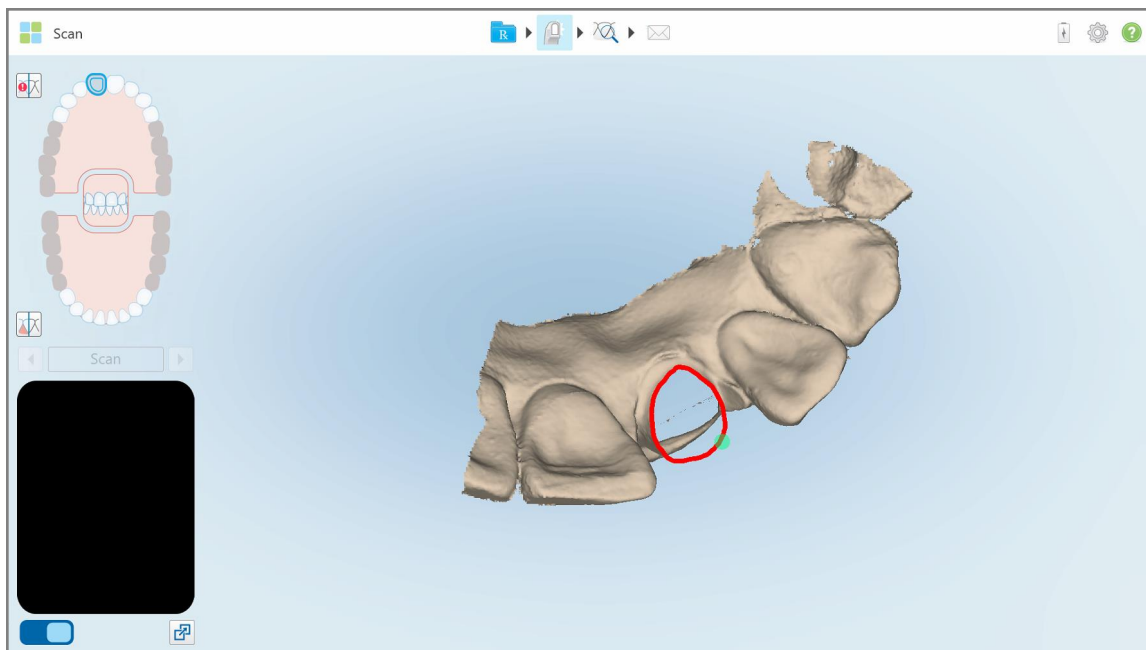



Figure 188: Deleted area marked in red

5. Tap the Occlusal Clearance tool  to confirm that the prepped tooth was sufficiently reduced.

## 10.8 Working with the Occlusal Clearance tool

The Occlusal Clearance tool  enables you to view the contact and distance between the opposing teeth, for example, to ensure that the prepped tooth has sufficient reduction for the material chosen in the Rx.

The Occlusal Clearance tool can be accessed while in View mode and from the Viewer.

**Note:** The Occlusal Clearance tool is displayed only after you have scanned the upper and lower jaws, and the bite.

To display the occlusal clearance while in View mode:

1. In the *View* window, tap the Occlusal Clearance tool .

The occlusal clearance between the opposing teeth is displayed.

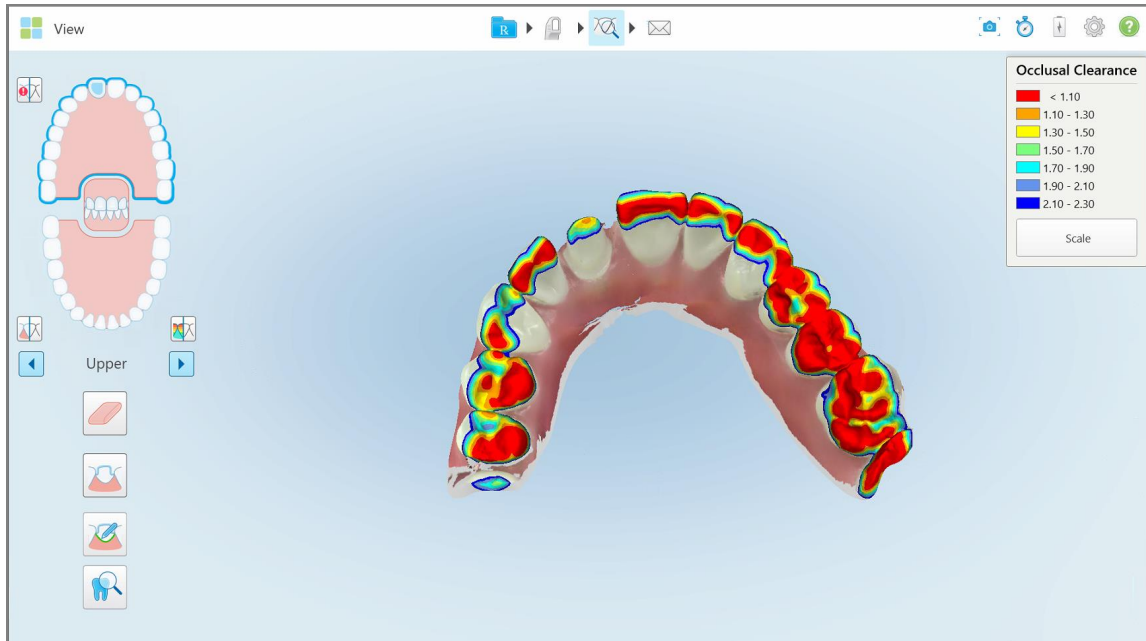

Figure 189: Occlusal clearance between the opposing teeth

2. If necessary, reduce the prepped tooth and rescan the area, as described in [Working with the Eraser tool](#).
3. If required, you can change the occlusal values displayed on the opposing teeth.

- a. On the legend, tap **Scale**.

The legend is expanded to display a list of range options.



Figure 190: Occlusal Clearance range options

- b. Select the required scale.
- c. The occlusal clearance is displayed according to the new scale.
4. If required, tap  to take a screenshot of the occlusal clearance. For more information on capturing screenshots and adding annotations, see [Working with the Snapshot tool](#).

#### To display the occlusal clearance from the Viewer:

1. Open the past order of a specific patient in the *Orders* page, or from a specific patient's profile page, tap **Viewer** to display the Viewer.



2. In the Viewer, tap .
3. Select the arch for which to display the occlusal clearance.

The clearance between the opposing teeth is displayed, as well as a legend displaying the scale.

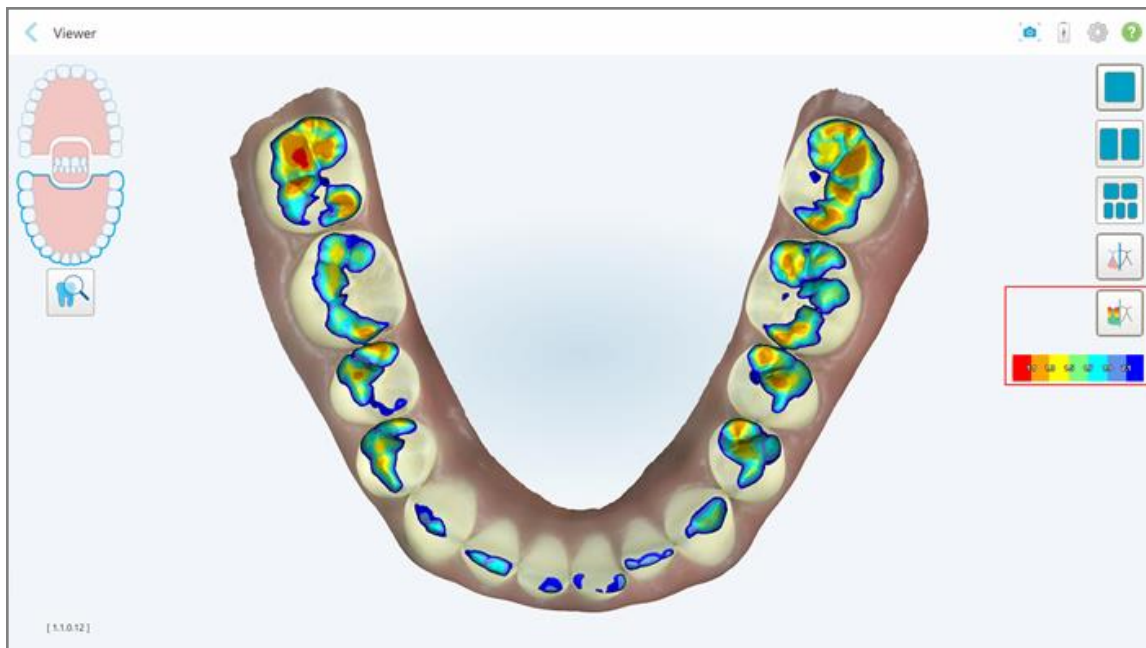





Figure 191: Occlusal Clearance tool and legend displayed in the Viewer

3. If required, tap  to take a screenshot of the occlusal clearance. For more information on capturing screenshots and adding annotations, see [Working with the Snapshot tool](#).

## 10.9 Working with the Edge Trimming tool

The **Edge Trimming** tool  enables you to trim away excess soft tissue such as cheek or lip artifacts from the scan. This tool is available for Orthodontic procedures only.

**To trim the excess material:**

1. In the *View* window, tap the Edge Trimming tool .

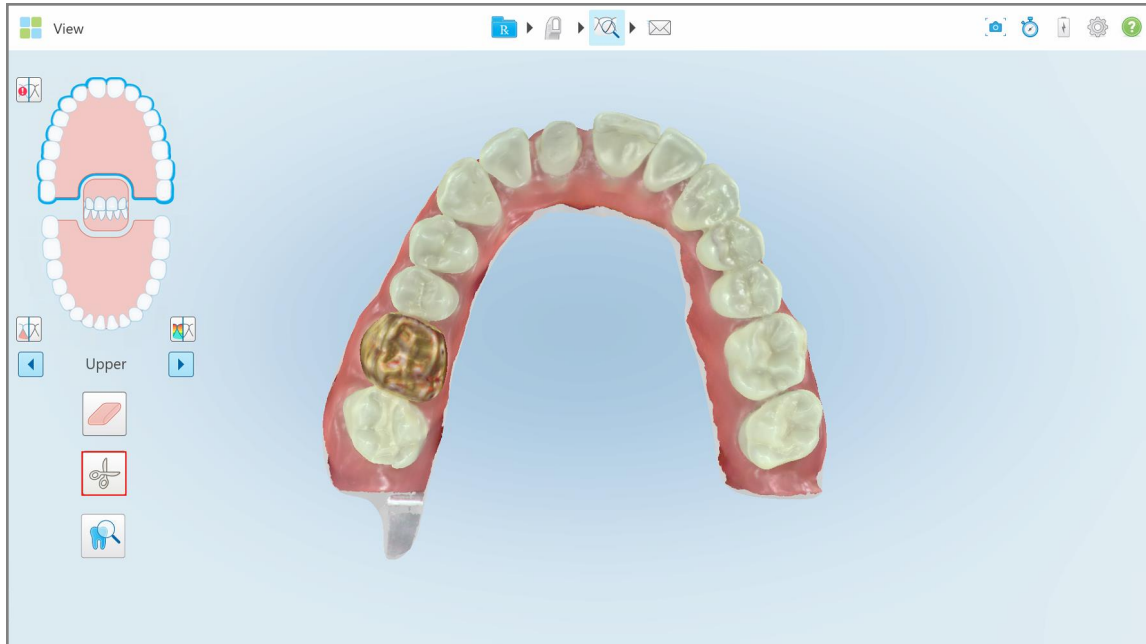

Figure 192: Edge Trimming tool

The Edge Trimming tool expands to show the following options:



Figure 193: Edge Trimming tool options

2. With your finger, mark the area you would like to trim away.

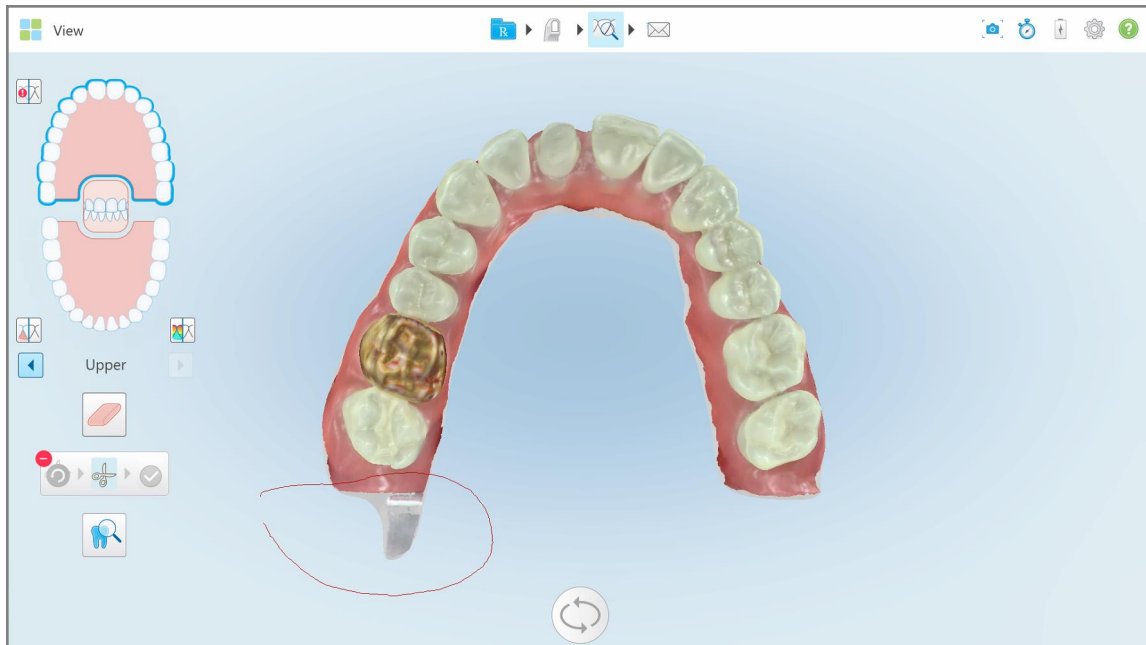

Figure 194: Mark the area to be trimmed away

The area to be trimmed away is highlighted and the confirmation icon is enabled.

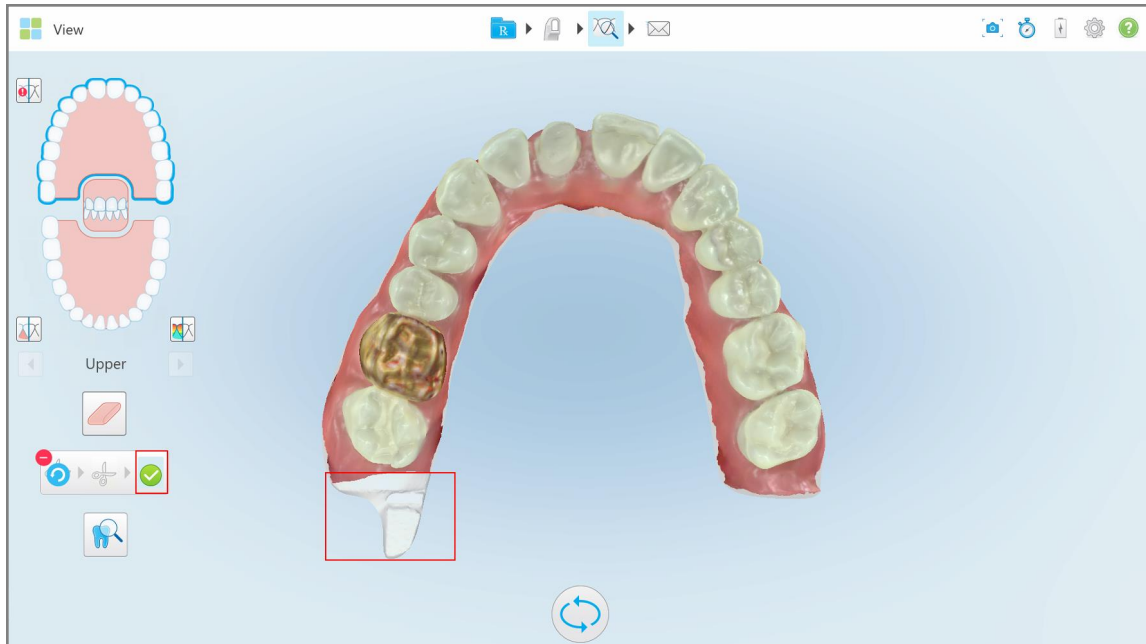



Figure 195: Selected area is highlighted, and the confirmation icon is enabled



3. If required, you can tap  to undo the trimming.
4. Tap  to confirm the trimming.  
The selected area is removed.

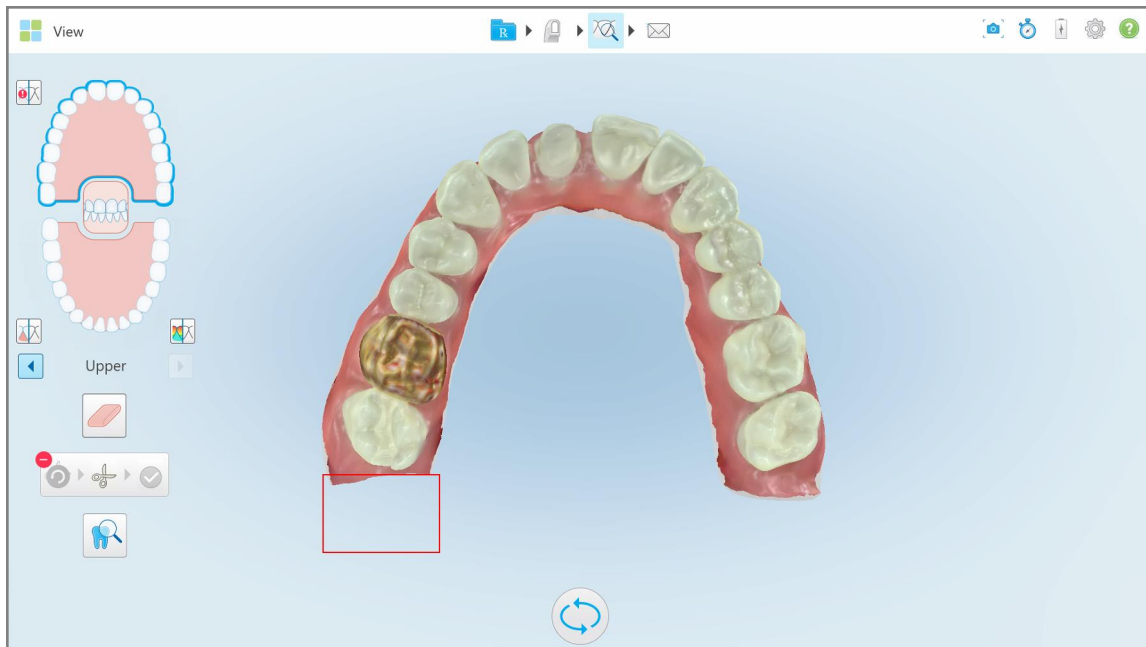

Figure 196: Selected area has been removed

## 10.10 Working with the Die Separation tool

The die separation is created automatically, according to the position of the green hint point, which must be located on the center of the prepped tooth after scanning.

If required, the die separation area can be edited or created manually.

### To display the die separation:

1. After scanning the prepped tooth, ensure that the green hint point is centered on the prepped tooth. Move it manually, if required.

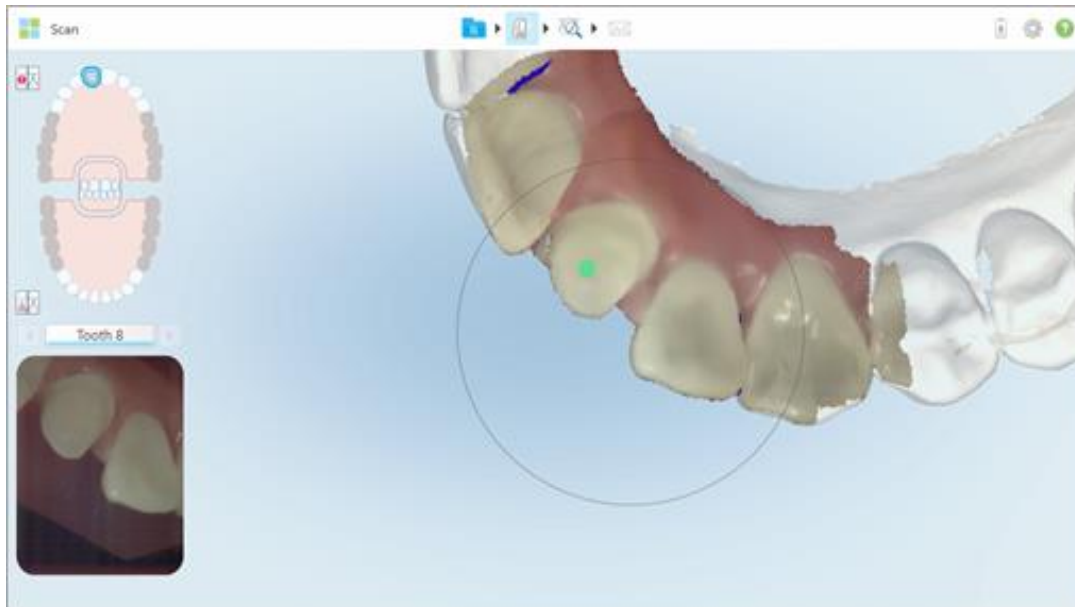



Figure 197: Green hint point centered on the prepped tooth

2. Tap  on the toolbar to move to **View** mode.
3. In the *View* window, tap the Die Separation tool .  
The die separation is displayed in high resolution.

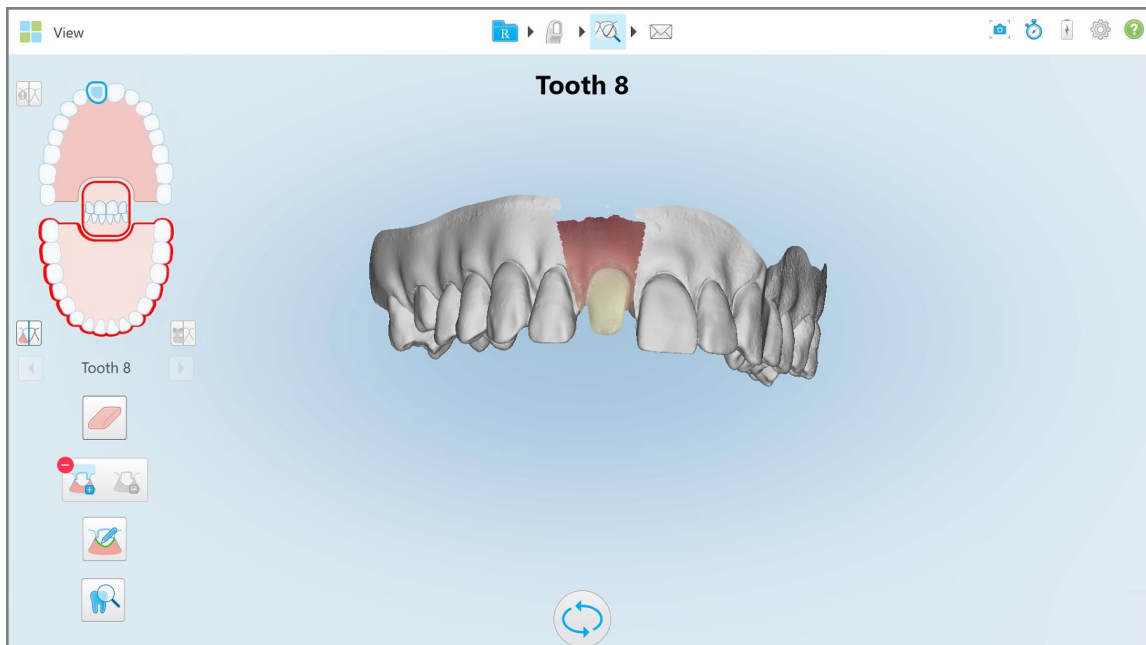

Figure 198: Die separation is displayed in high resolution

**To create the die separation manually:**

1. In the *View* window, tap the Die Separation tool .

The tool expands to show the following options:



Figure 199: Die Separation tool options

2. Tap  and mark the whole segment with your finger.

The scan is displayed in low resolution.

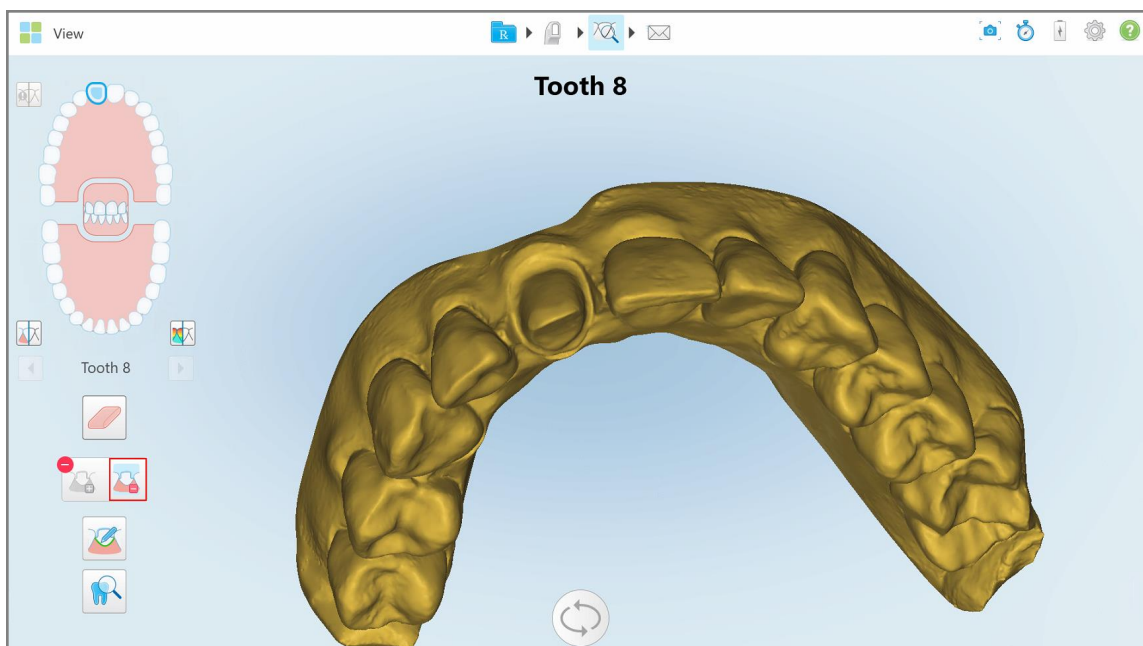



Figure 200: Scan is displayed in low resolution

3. Tap  to mark the prepped tooth in high resolution.

The model is displayed as follows:

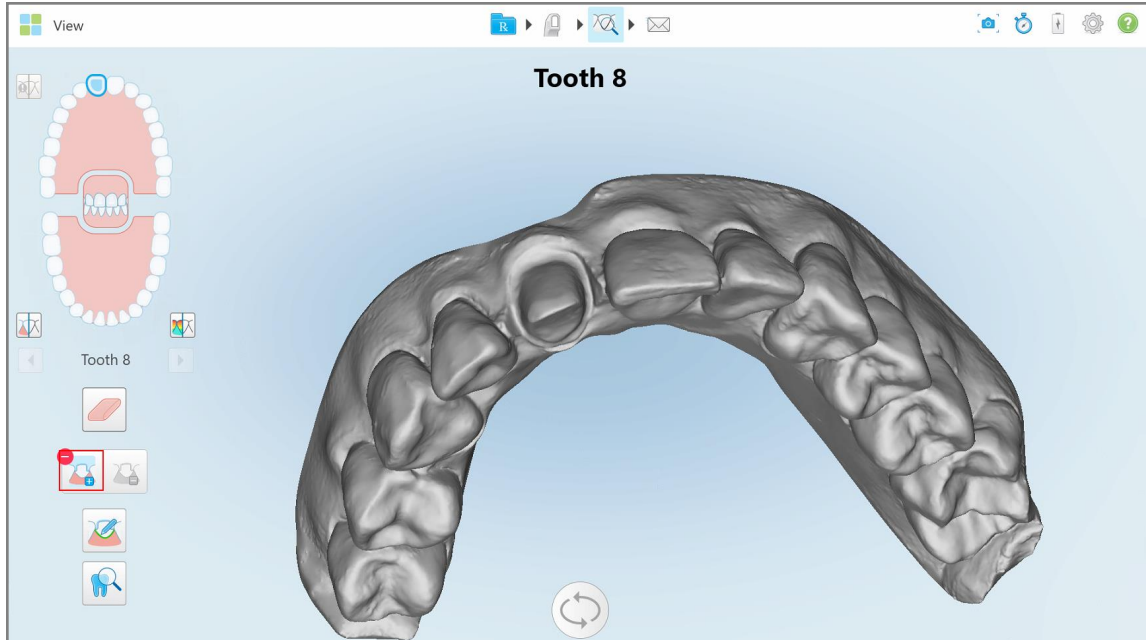

Figure 201: Before selecting the die separation

4. Draw the area for the die separation.

The selected area is displayed in high resolution.

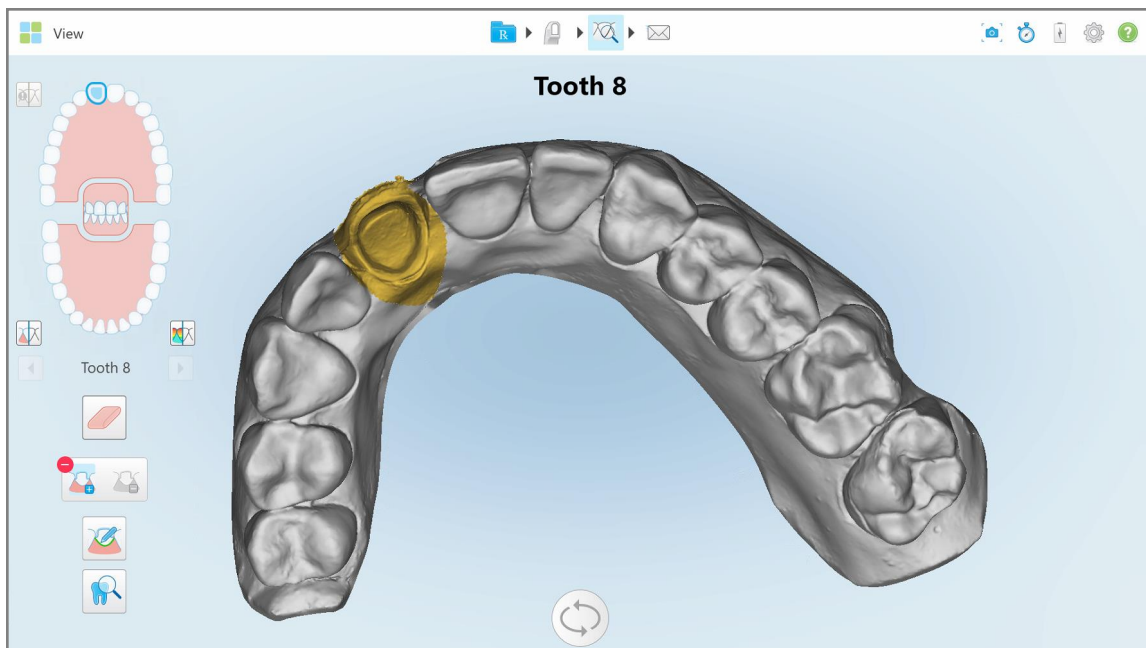

Figure 202: Prepped tooth is displayed in high resolution

## 10.11 Working with the Margin Line tool



The Margin Line tool automatically detects and marks the margin line on Fixed Restorative procedures that require crowns. If required, it can be marked manually for other indications. Once the margin line has been created, you can tweak it or recreate it if it has been deleted.

### 10.11.1 Automatically defining the margin line

The Margin Line tool automatically detects and marks the margin line on Fixed Restorative procedures that require crowns.

**Note:** The margin line may not be created automatically if:

- The prepped tooth was not scanned properly.
- The wrong die separation was used – the green dot was not centered on the prepped tooth while scanning – therefore part of the scan is not within the die separation area.

If the margin line cannot be created automatically, you will receive a message notifying you of this, and you can manually define the margin line, as described in [Manually defining the margin line](#).

**To define the margin line automatically:**

1. In the *View* window, tap the prepped tooth in the navigation controls.

The 3D model display moves to the occlusal view and zooms in on the prepped tooth.

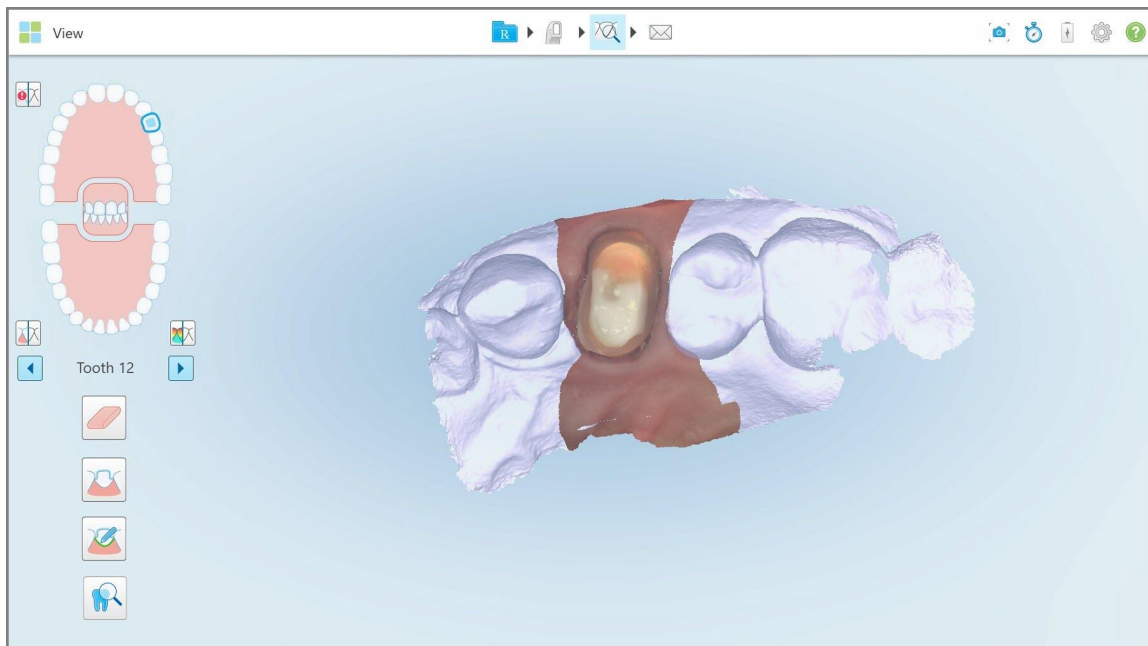

Figure 203: Model display moves to the occlusal view, and zooms in on the prepped tooth

2. Tap the Margin Line tool .

The Margin Line tool expands to show the following options:



Figure 204: Margin Line tool options

A message is displayed prompting you to wait while the automatic AI-based margin line is being detected. After a few seconds, the margin line is automatically marked on the prepped tooth. The teeth adjacent to the prepped tooth appear transparent, enabling you to see the edges of the margin line.

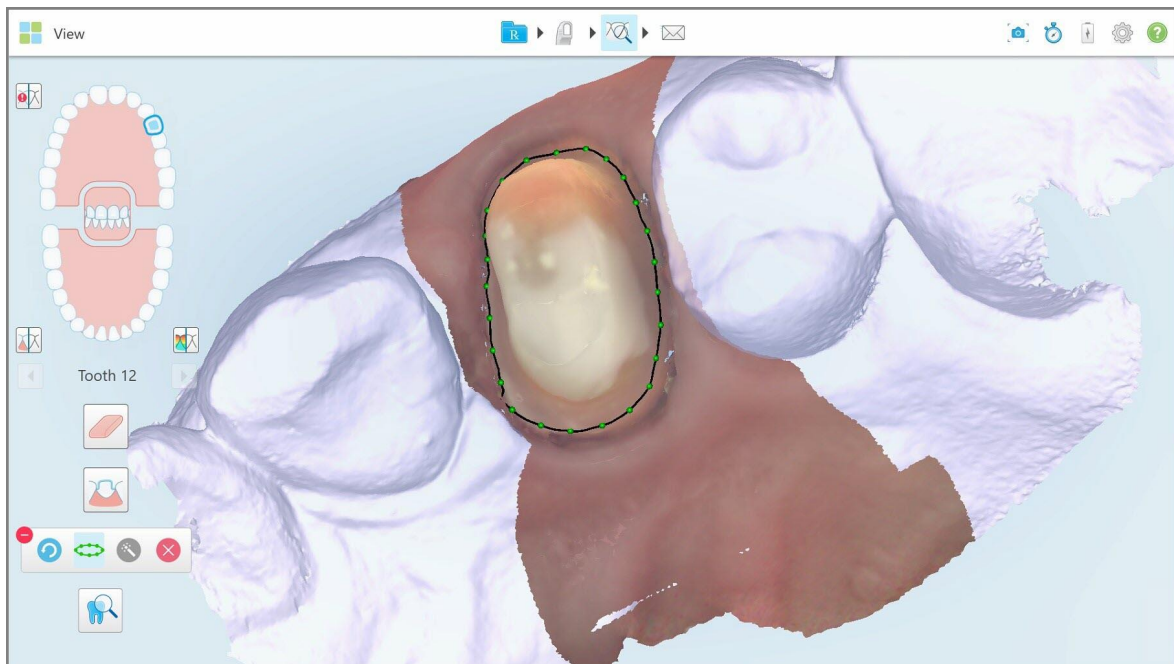





Figure 205: Margin line is marked on the prepped tooth

3. Tweak the margin line if required, by dragging any of the green control points.
4. If required, click  to undo the last action. You can click the button to undo the last 50 actions.
5. If required, click  to delete the margin line.
6. If required, click  to redisplay the deleted margin line.

### 10.11.2 Manually defining the margin line

If the margin line cannot be defined automatically, you can define it manually.

#### To define the margin line manually:

1. In the *View* window, tap the prepped tooth in the navigation controls.

The 3D model display moves to the occlusal view and zooms in on the prepped tooth.

2. Tap the Margin Line tool .

The Margin Line tool expands to show the following options:



Figure 206: Margin Line tool options

3. Tap  and then tap around the prepped tooth to draw a point-by-point line of at least 6–8 points.

**Note:** Make sure to close the margin line. If you do not complete the margin line and try sending the scan, you will receive a notification that the partial margin line will be deleted. You can go back and complete the margin line.

## 10.12 Working with the Review tool (iTero Element 5D and 5D Plus)

**Note:** This section is for iTero Element 5D and 5D Plus systems only. If you have an iTero Element 5D Plus Lite system, please see [Working with the Review tool \(iTero Element 5D Plus Lite\)](#).

The View mode includes a **Review tool** that enables you to view the NIRI and colored intraoral images captured during the scan, for every area of interest. These images are displayed one below the other in the image pane, on the right of the *View* window.

In addition, you can:

- Zoom in and out of the images in the image pane, as described in [Zooming in to and out of the images in the image pane](#)
- Adjust the brightness and contrast of the images in the image pane, as described in [Adjusting the brightness and contrast of images in the image pane](#)
- Capture screenshots of the images, as described in [Working with the Snapshot tool](#)

When reviewing the 3D model as a NIRI image, the upper and lower jaw orientation has been set to look as if you are looking into the patient's mouth.

**Note:** If you notice an issue with a NIRI image, please contact Customer Support.

**To activate the Review tool:**

- In the View window, tap  and then drag the loupe from the right pane over an area of interest.

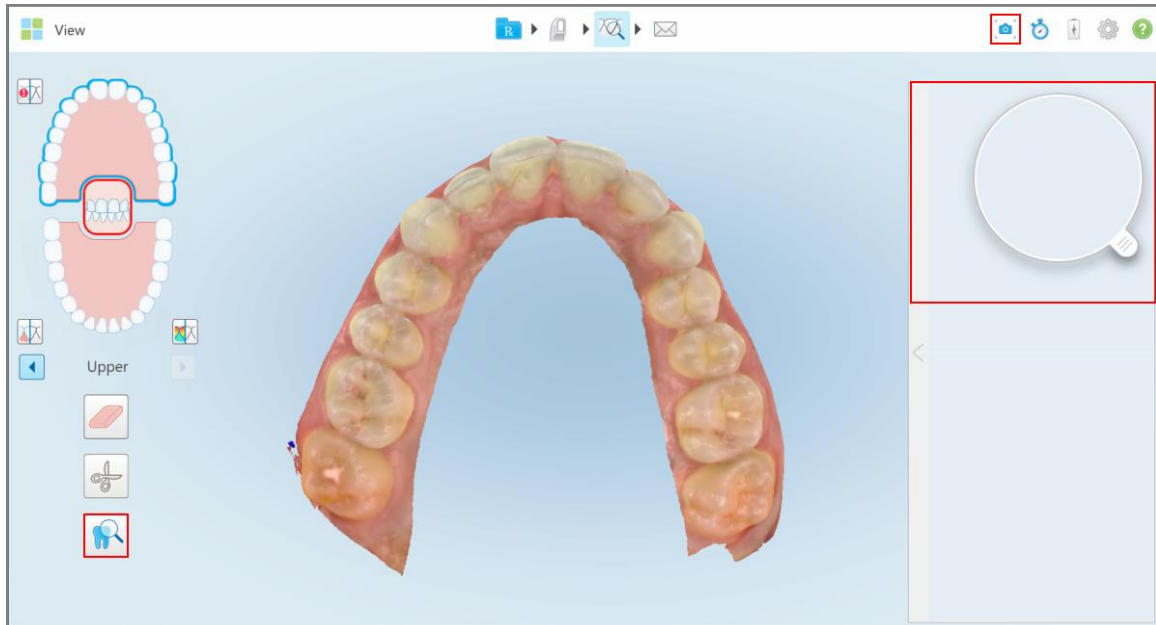

**Figure 207: Review tool with the Snapshot tool on the toolbar and the loupe in the right pane**

The area within the loupe is displayed in the image pane on the right. The display in the image pane changes according to the position of the loupe.



A NIRI and colored intraoral image are displayed one below the other in the image pane on the right. The NIRI and colored intraoral images in the image pane match the direction of the loupe and are updated simultaneously while moving the loupe over the 3D display.

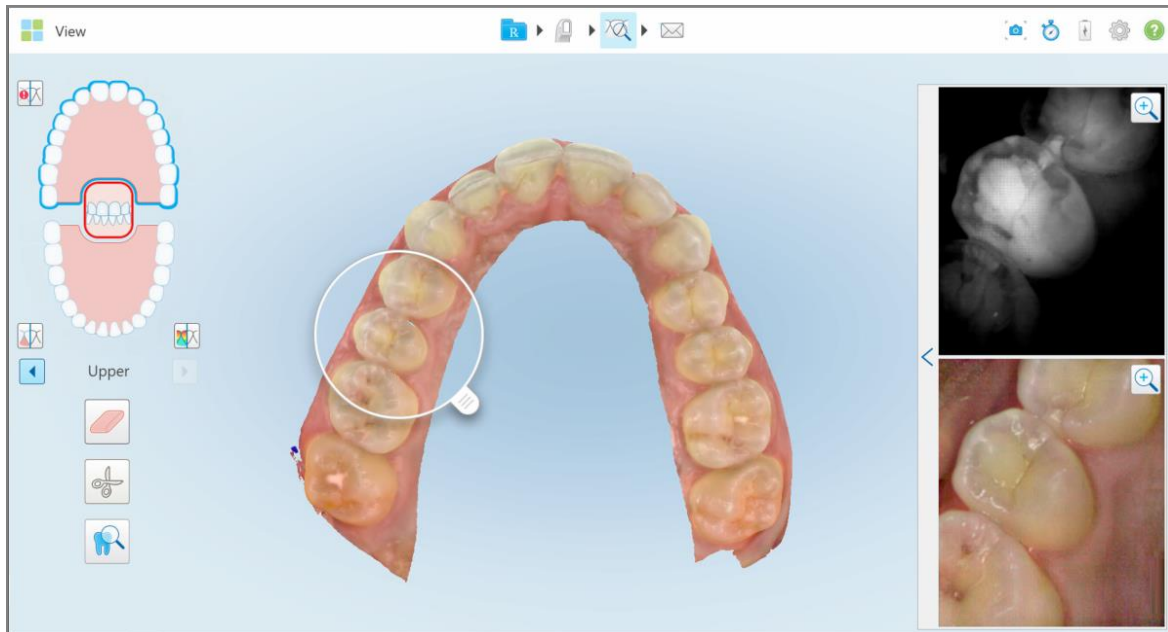

Figure 208: Image pane on the right showing the area of interest as both NIRI and colored intraoral images

### 10.12.1 Zooming in to and out of the images in the image pane

In order to better evaluate the scanned images in the image pane, you can zoom in to and out of the images, as well as adjust the contrast and brightness of each image.

You can zoom in to or out of the selected area of the images displayed in the image pane using the following methods:

- Using a spreading or pinching gesture on one of the images displayed in the image pane
- Double-tapping an image in the image pane to toggle zoom in/zoom out
- Tapping the zoom button displayed on the required image

Zooming in or out using the first two methods will enlarge or decrease the size of both image pane images simultaneously, but keep the image pane windows the same size.

Zooming in using the zoom tool will enlarge the image pane and display only the relevant image.

**To zoom in or out using the zoom button:**

1. Tap  on either the NIRI or the colored intraoral image to zoom in to that view.

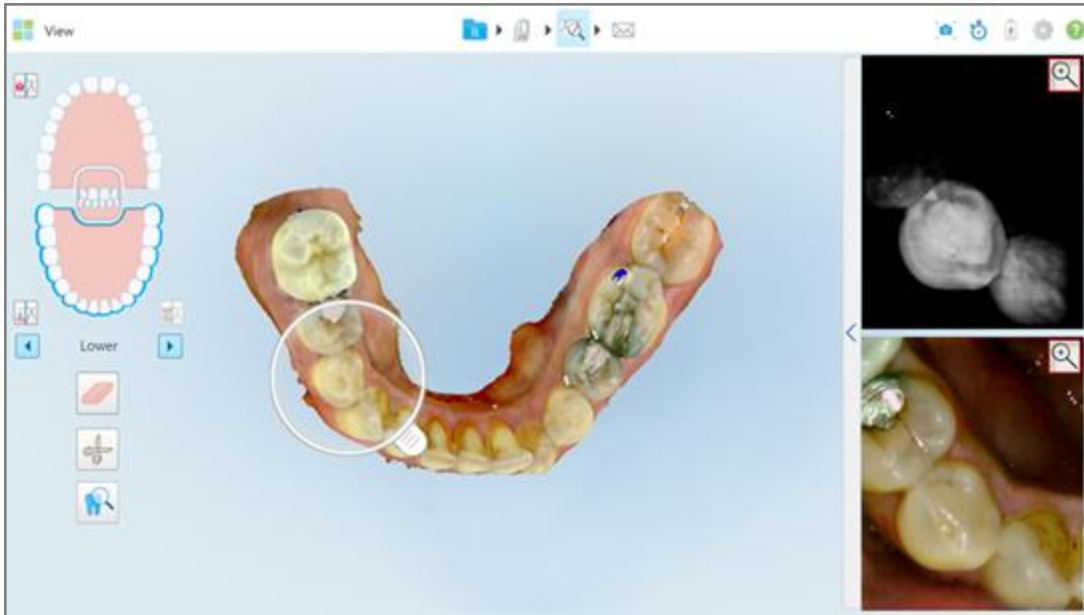

Figure 209: Zoom-in buttons on the images in the image pane

The image in the image pane is enlarged and only the specific image is displayed.

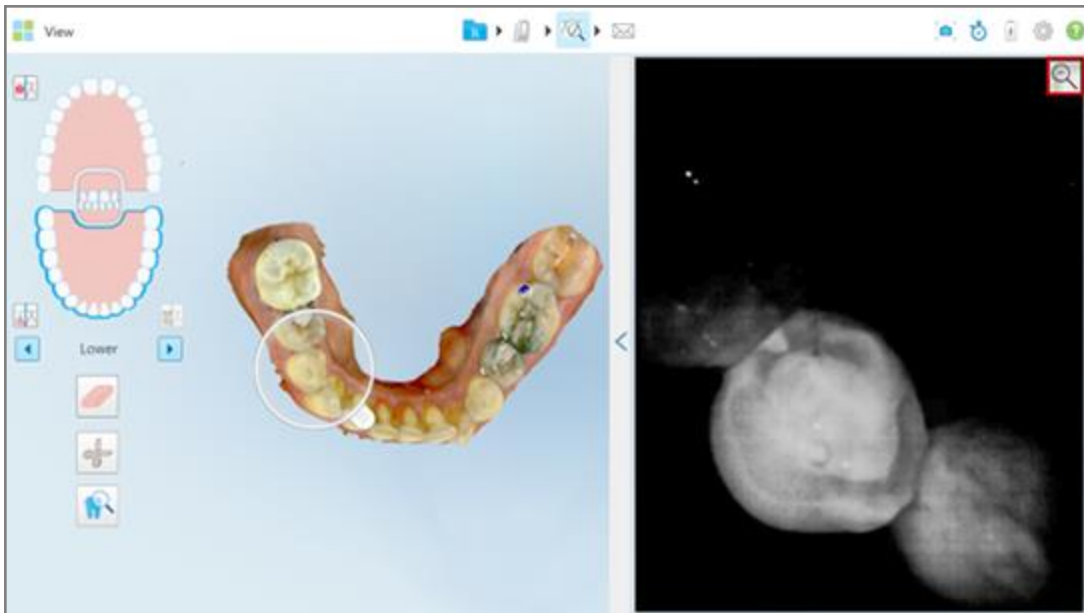



Figure 210: Only the zoomed-in image is displayed in the enlarged image pane window

2. Tap  on the enlarged 2D image to return the image to the default size.

### 10.12.2 Adjusting the brightness and contrast of images in the image pane

You can set the brightness and contrast of each of the images displayed in the image pane by adjusting the relevant sliders in the brightness and contrast toolbar.

- **Brightness** refers to the overall lightness or darkness of an image. Increasing the brightness makes every pixel in the image lighter, and vice versa.
- **Contrast** is the difference in **brightness** between objects in an image. Increasing the contrast makes light areas lighter and dark areas darker, and vice versa.

By default, the brightness and contrast toolbar is collapsed.

**Note:** The color and brightness controls are displayed only when images are displayed in the image pane, and not when the loupe is in its default position in the right pane.

The contrast and brightness image controls are reset to their default values when selecting a different jaw, pushing the loupe back to its default position, or when exiting the tool.

**To adjust the brightness and contrast of the images in the image pane:**

1. Tap  on the left edge of the image pane to display the brightness and contrast adjustment toolbar.

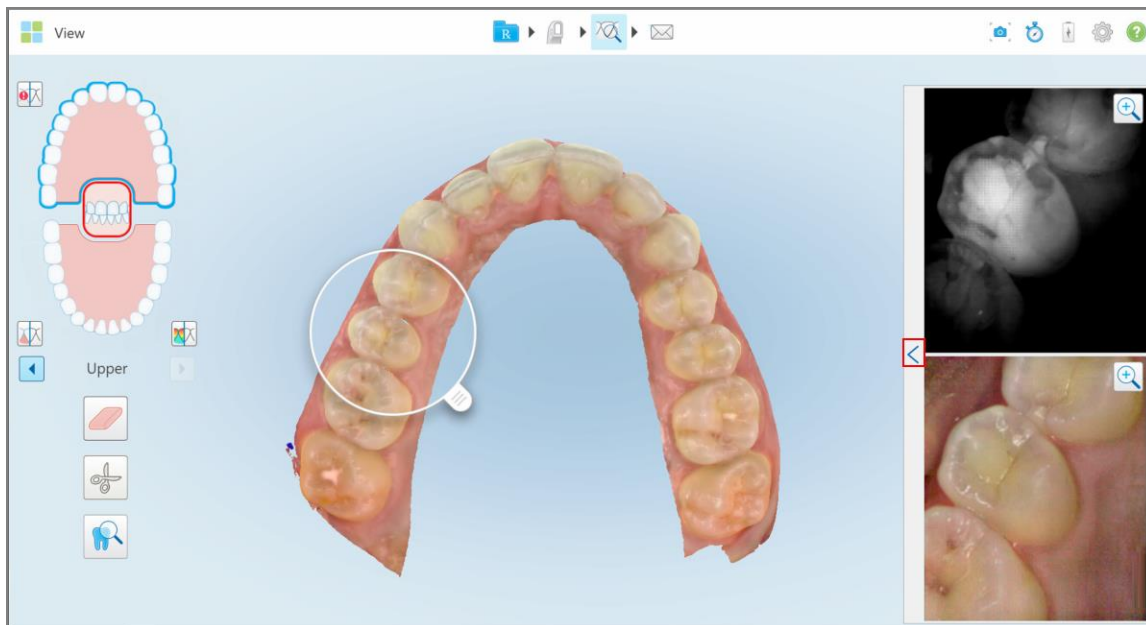

Figure 211: Brightness and contrast toolbar is collapsed

A brightness and contrast adjustment toolbar is displayed on each of the windows in the image pane. By default, the brightness level is set to the lowest position and the contrast is set to the middle position.

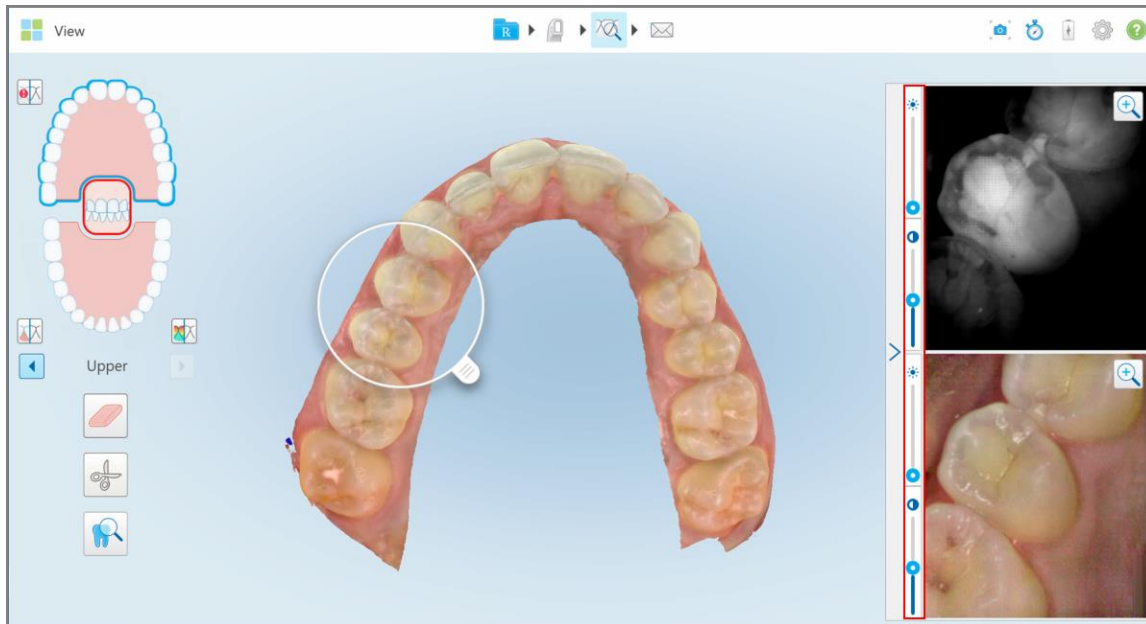



Figure 212: Brightness and contrast toolbars

2. Move the slider up or down to adjust the brightness  or contrast.
 

**Tip:** You can tap anywhere in the slider area and drag up or down to adjust the settings.
3. Tap  to collapse the toolbar.

### 10.12.3 Capturing the Review tool images

If required, you can capture the images displayed when using the Review tool. These images become part of the patient's export package, and can later be downloaded from MyiTero.

For more information, see [Working with the Snapshot tool](#).

### 10.13 Working with the Review tool (iTerо Element 5D Plus Lite)

The View mode includes a **Review tool** that enables you to view the colored intraoral images captured during the scan, for every area of interest. These images are displayed in the image pane, on the right of the View window.

In addition, you can:

- Zoom in and out of the image in the image pane, as described in [Zooming in to and out of the images in the image pane](#)
- Adjust the brightness and contrast of the image in the image pane, as described in [Adjusting the brightness and](#)

[contrast of images in the image pane](#)

- Capture screenshots of the image, as described in [Working with the Snapshot tool](#)

**To activate the Review tool:**

- In the View window, tap  and then drag the loupe from the right pane over an area of interest.

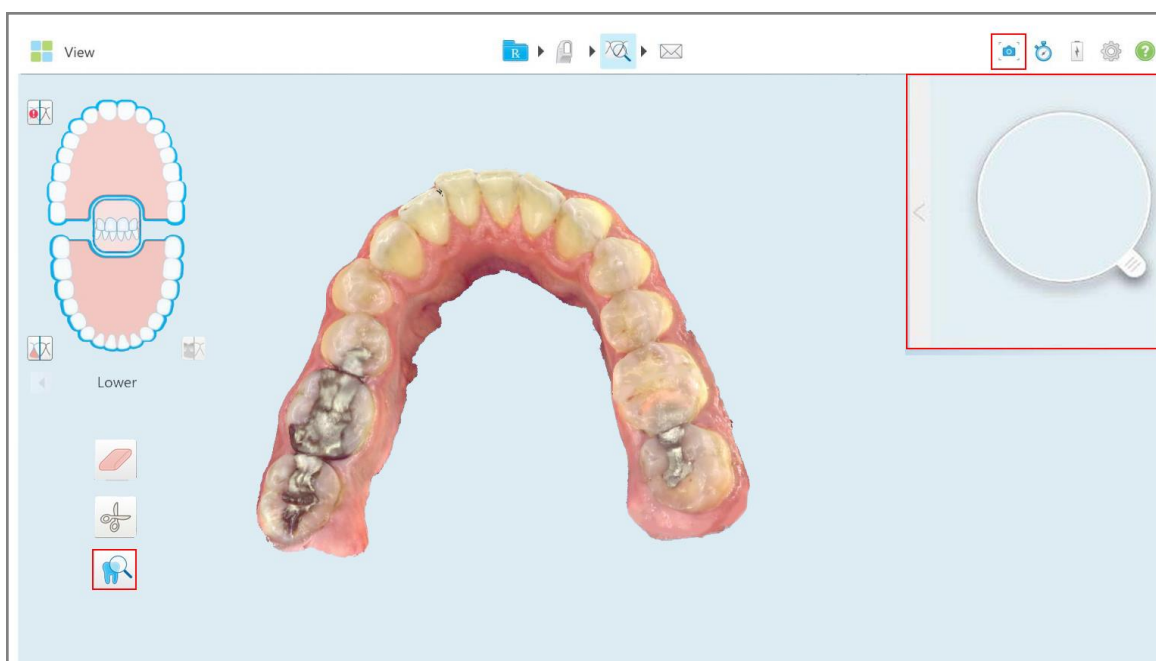

Figure 213: Review tool with the Snapshot tool on the toolbar and the loupe in the right pane

The area within the loupe is displayed in the image pane on the right. The display in the image pane changes according to the position of the loupe.

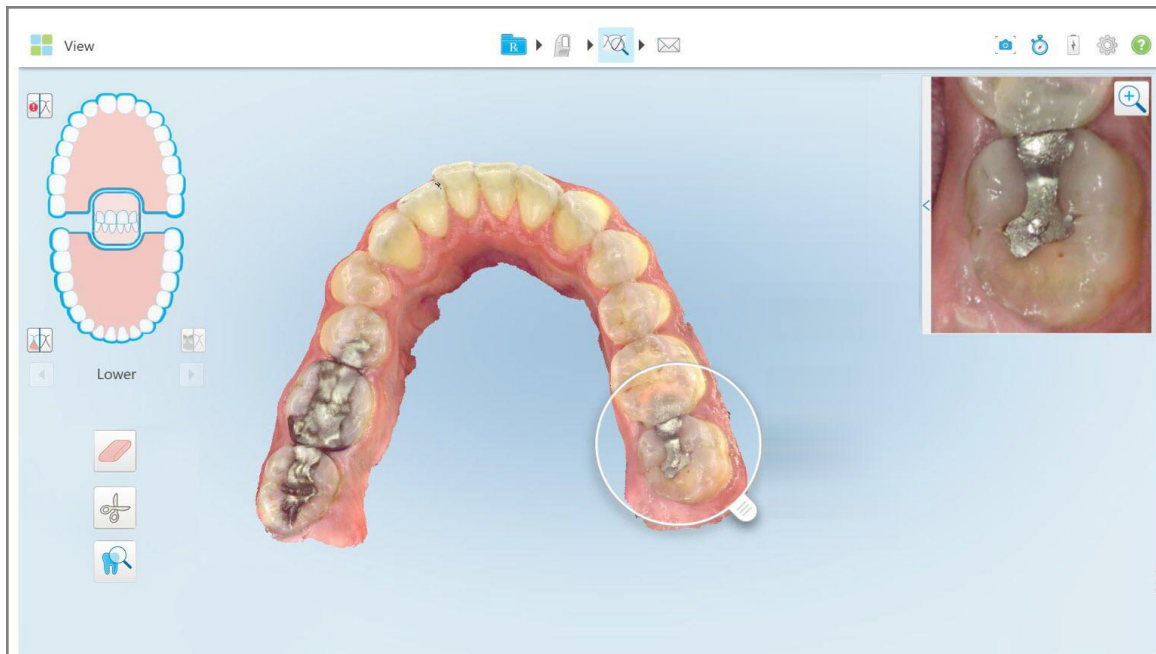

Figure 214: Image pane on the right showing the area of interest

### 10.13.1 Zooming in to and out of the images in the image pane

In order to better evaluate the scanned image in the image pane, you can zoom in to and out of the image, as well as adjust the contrast and brightness of the image.

You can zoom in to or out of the selected area of the image displayed in the image pane using the following methods:

- Using a spreading or pinching gesture on the image displayed in the image pane
- Double-tapping the image in the image pane to toggle zoom in/zoom out
- Tapping the zoom button displayed on the image

**To zoom in or out using the zoom button:**

1. Tap  on the colored intraoral image to zoom in to the area of interest.

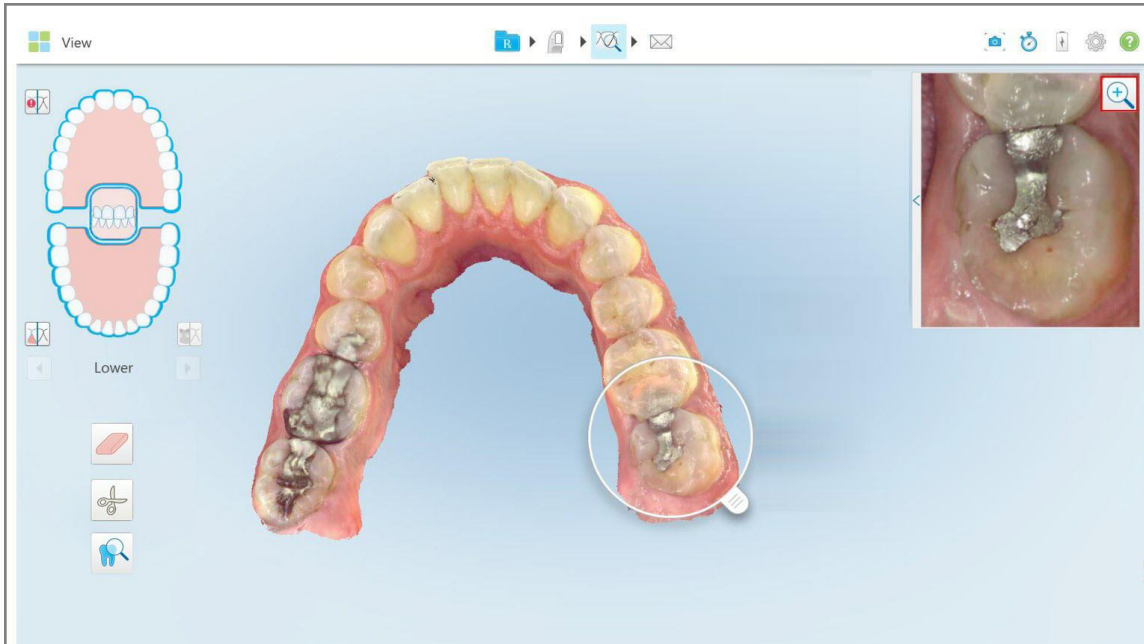

**Figure 215: Zoom-in button on the image in the image pane**

The image pane is enlarged to display the zoomed-in image.

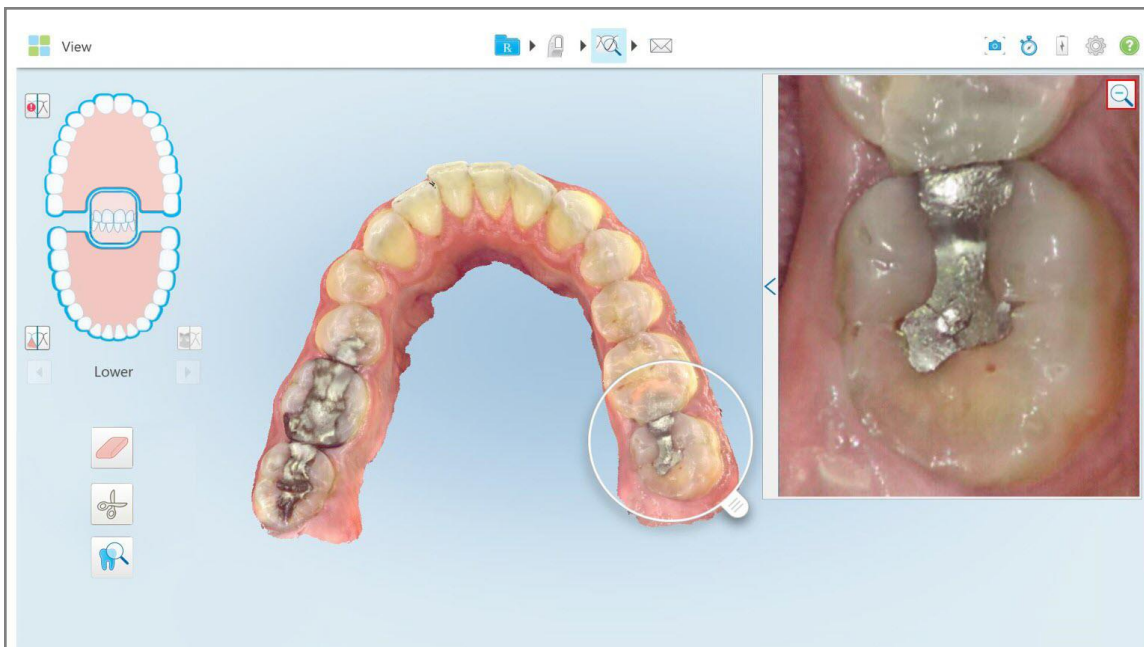

**Figure 216: Zoomed-in image displayed in the enlarged image pane**

2. Tap  on the enlarged 2D image to return the image to the default size.

### 10.13.2 Adjusting the brightness and contrast of images in the image pane

You can set the brightness and contrast of the images displayed in the image pane by adjusting the relevant sliders in the brightness and contrast toolbar.

- **Brightness** refers to the overall lightness or darkness of an image. Increasing the brightness makes every pixel in the image lighter, and vice versa.
- **Contrast** is the difference in **brightness** between objects in an image. Increasing the contrast makes light areas lighter and dark areas darker, and vice versa.

By default, the brightness and contrast toolbar is collapsed.

**Note:** The color and brightness controls are displayed only when an image is displayed in the image pane, and not when the loupe is in its default position in the right pane.

The contrast and brightness image controls are reset to their default values when selecting a different jaw, pushing the loupe back to its default position, or when exiting the tool.

**To adjust the brightness and contrast of the images in the image pane:**

1. Tap  on the left edge of the image pane to display the brightness and contrast adjustment toolbar.

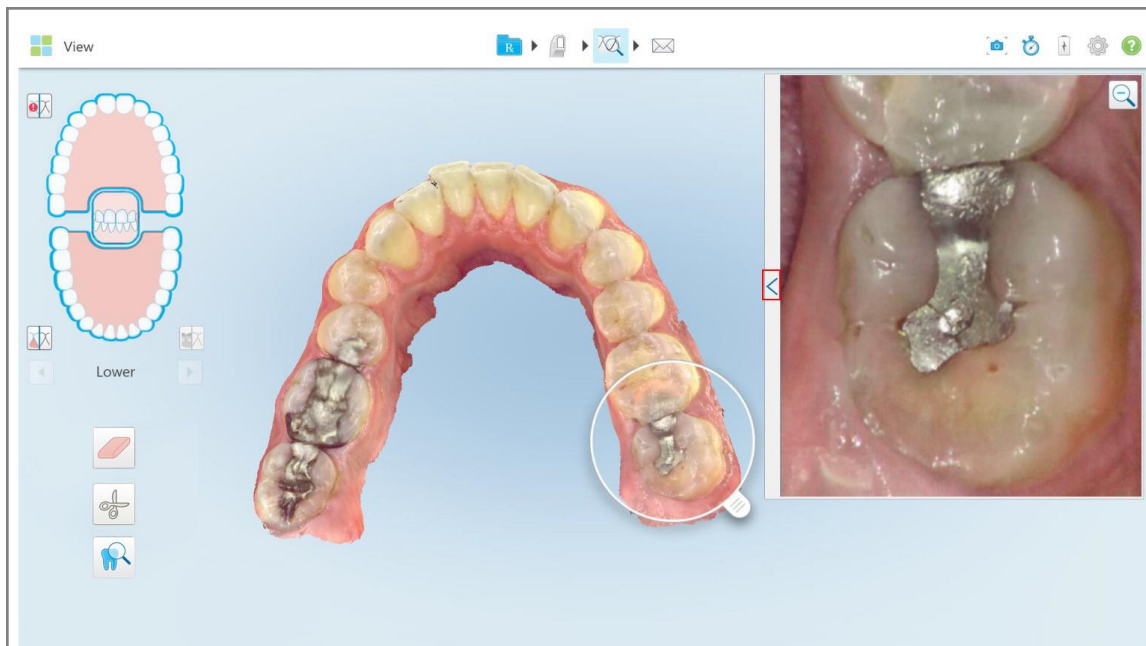

Figure 217: Brightness and contrast toolbar is collapsed



A brightness and contrast adjustment toolbar is displayed on window in the image pane. By default, the brightness level is set to the lowest position and the contrast is set to the middle position.

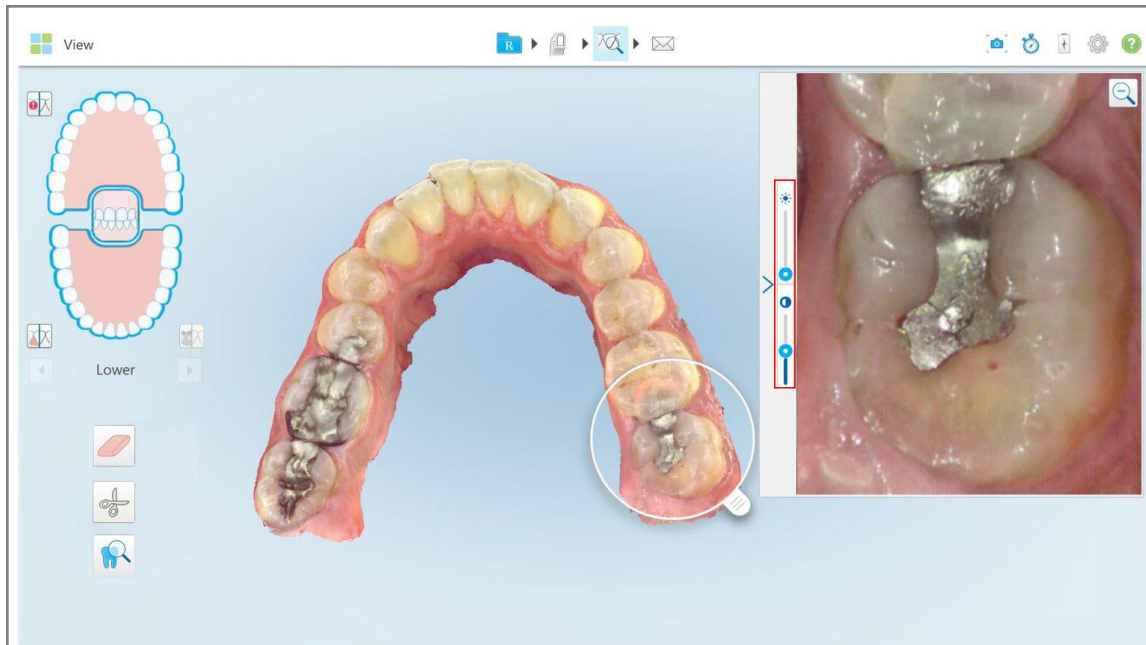



Figure 218: Brightness and contrast toolbar

2. Move the slider up or down to adjust the brightness  or contrast.

**Tip:** You can tap anywhere in the slider area and drag up or down to adjust the settings.

3. Tap  to collapse the toolbar.

### 10.13.3 Capturing the Review tool images

If required, you can capture the images displayed when using the Review tool. These images become part of the patient's export package and can later be downloaded from MyiTero.

For more information, see [Working with the Snapshot tool](#).

## 10.14 Working with the Snapshot tool

The Snapshot tool enables you to capture screenshots of the scanned model. These screenshots become part of the patient's export package and can later be downloaded from MyiTero. In addition, these screenshots can be added to the iTerо Scan Report, created in MyiTero.

Once the image has been captured, you can add annotations, if required.

By default, each time you tap the Snapshot tool, the following images are captured and saved in a separate folder, whose name includes the Order ID, and date and time of the screenshots:

- Entire View window
- 3D image

If you are taking screenshots while using the Review tool, the following screenshots are included:

- Entire Review tool window, including 3D image, and 2D NIRI and color viewfinder images

**Note:** The 2D NIRI image is not displayed for iTerо Element 5D Plus Lite systems.

- 3D image
- 2D NIRI viewfinder image (if the loupe has been dragged onto the 3D image) [Toggling between color and NIRI images in the viewfinder](#)
- 2D color viewfinder image (if the loupe has been dragged onto the 3D image)

Each set of screenshots is saved in a separate folder and saved in a folder with the patient's name, which can be downloaded from MyiTero as a zipped file.

Screenshots can be captured from any window that includes the Snapshot tool  on the scanner toolbar.

To capture a screenshot of a scanned image:

1. In **View** mode, tap the Snapshot tool  on the toolbar.

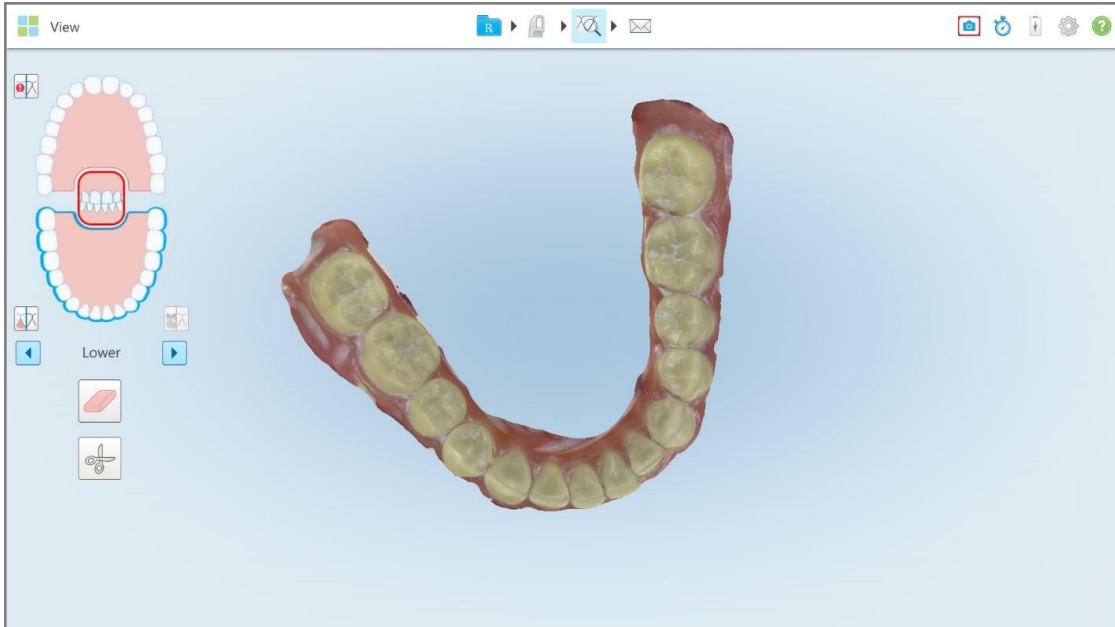

Figure 219: View mode – with Snapshot tool

The screen flashes, indicating that the screenshot was captured. A thumbnail of the screenshot is displayed on the bottom left of the window and remains for 7 seconds.

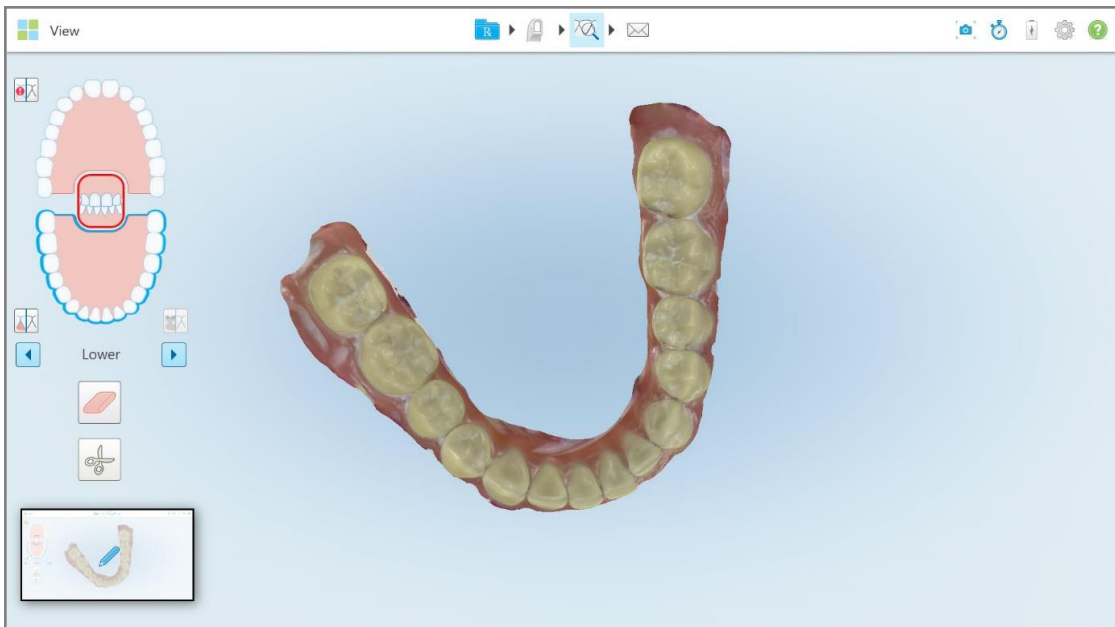

Figure 220: Screen capture thumbnail is displayed after taking a screen capture

2. Tap the thumbnail if you would like to add annotations to the screenshot.

The *Draw* window is displayed, showing a screenshot of the entire window, with an annotations toolbar on the top.

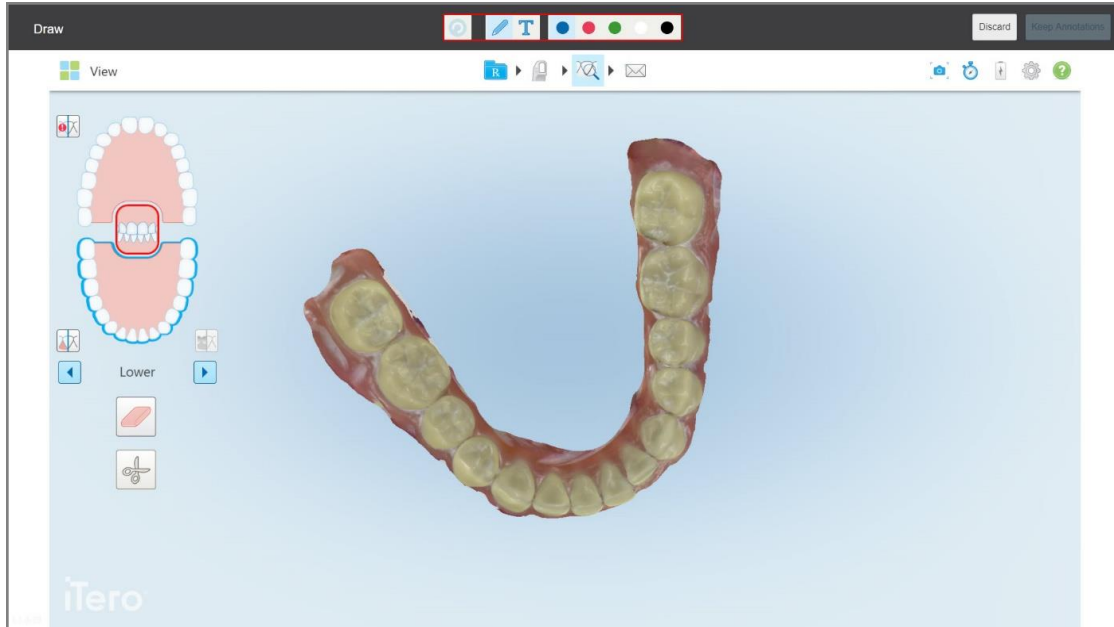







Figure 221: Screenshot with an annotations toolbar



Figure 222: Annotations toolbar

The annotations toolbar contains the following buttons:

- |   |   |
|---|---|
|  | Tap to undo previous annotations.   |
|  | Tap to draw on the screenshot.  |
|  | Tap to enter text on the screenshot.  |
|  | Tap the color for the drawing and text. By default, these will be the same color. |

3. Tap the required tool and color and then add your annotations. After adding text, tap  to save the text in the color selected.

**Note:** If you do not tap  after entering text, the color of the text will be changed if you select a different color for the next annotation.

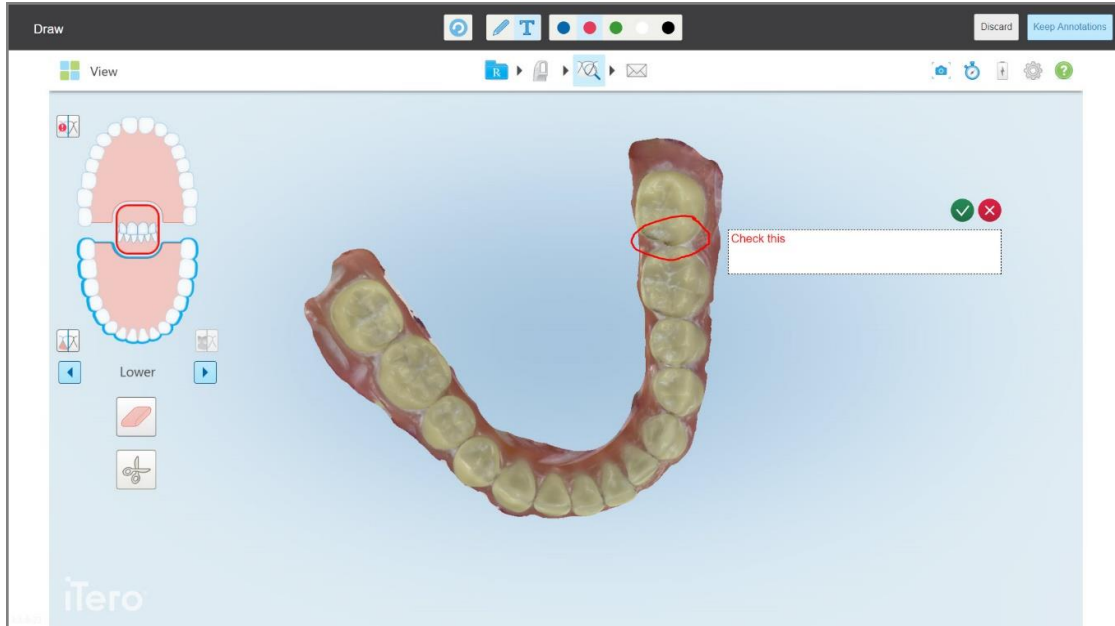

Figure 223: Adding text to the screenshot

4. To save the screenshot with the annotations, tap **Keep Annotations**.

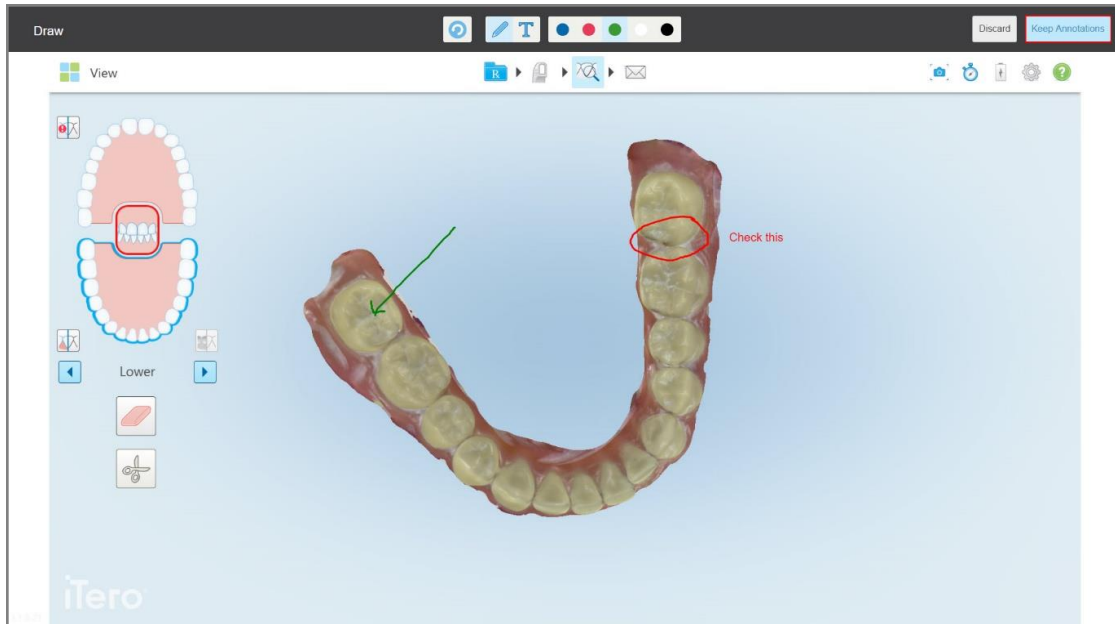

Figure 224: Screenshot with annotations

A pop-up message is displayed at the bottom of the screen, notifying you that the screenshots and annotations will be uploaded to MyiTero, where you can access them.

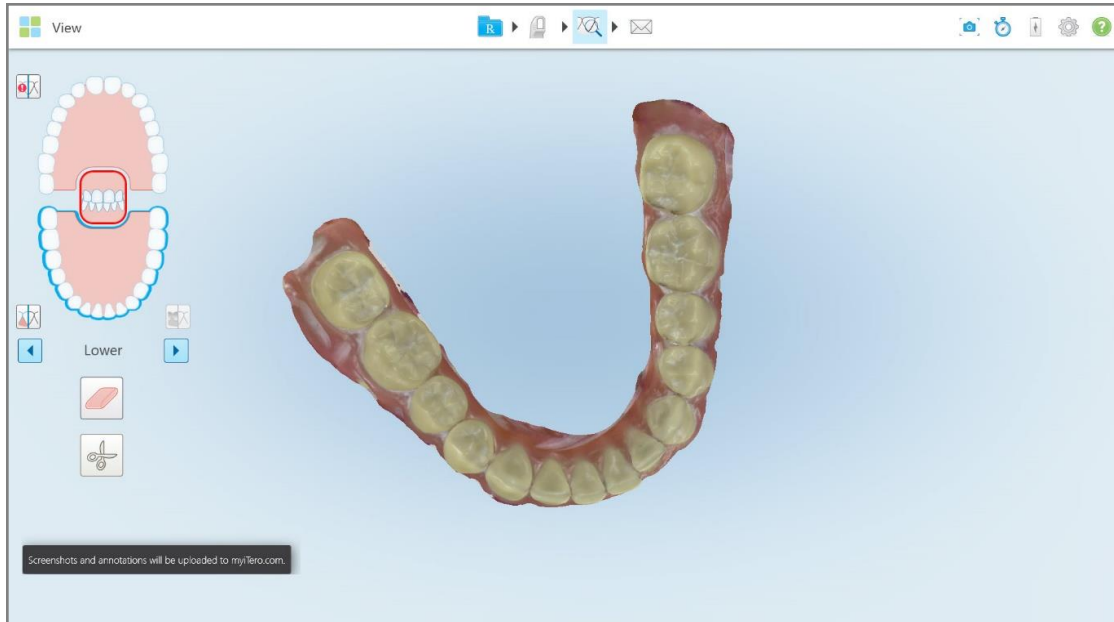

Figure 225: Notification that the screenshots and annotations will be uploaded to MyiTero

5. To save only the screenshots without the annotations, tap **Discard**.

A confirmation message is displayed.

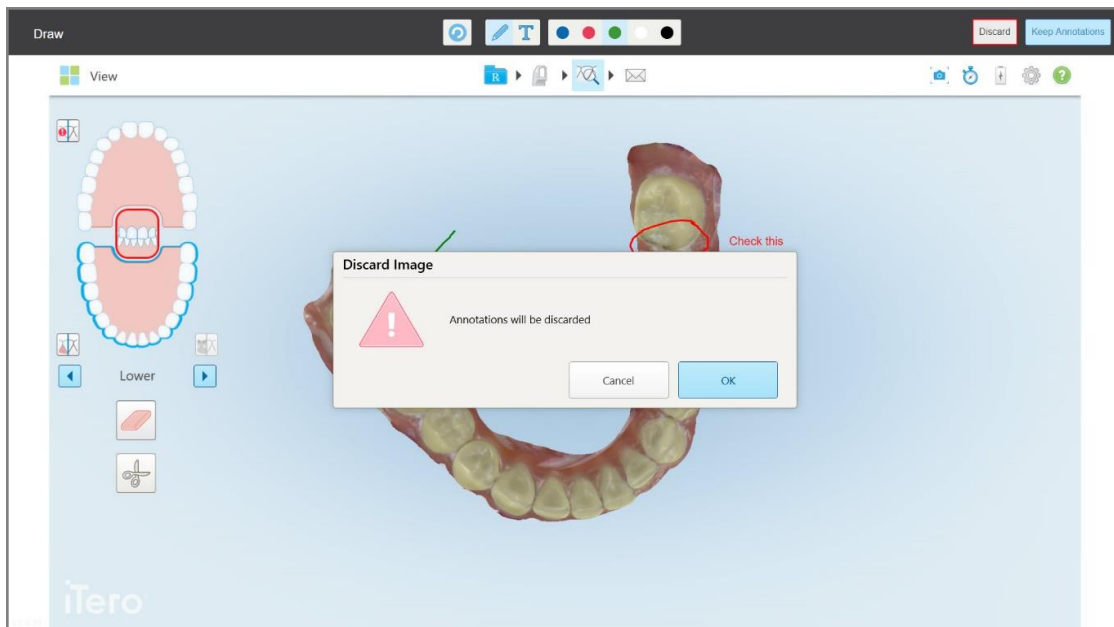
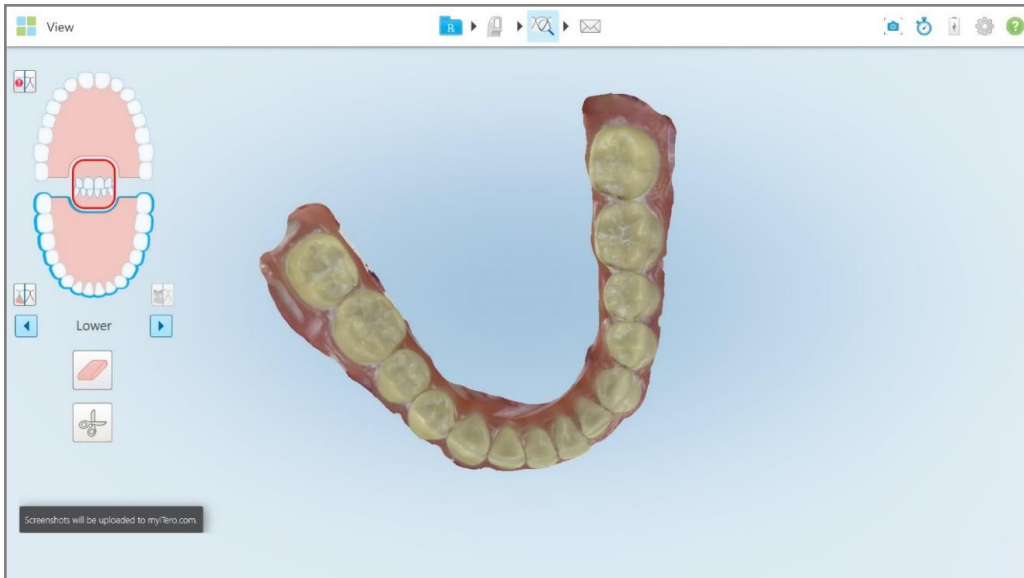

Figure 226: Confirmation about the annotations being discarded

a. Tap **OK** to proceed.

A pop-up message is displayed notifying you that the screenshots will be uploaded to MyiTero.



**Figure 227: Notification that the screenshots will be uploaded to MyiTero**

The screenshots can now be downloaded from MyiTero, from the *Orders* page, or from the *Viewer*.

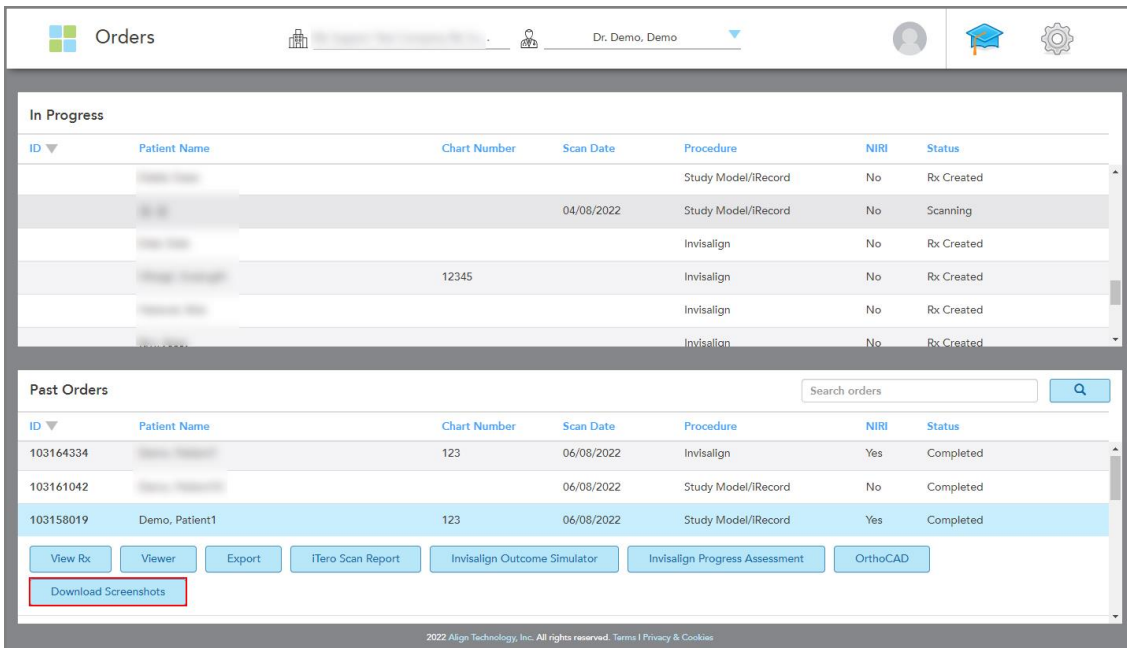

**Figure 228: Option to download screenshots from the Orders page in MyiTero**

**Note:** The **NIRI** column is not displayed for iTero Element 5D Plus Lite systems.

## 11 Care and maintenance

If you are performing any sanitation procedures in the office that involve fogging or spraying, make sure that the iTerO scanner is not in the room.

To avoid cross-contamination, it is mandatory to:

- Clean and disinfect the scanner components, as described in the following sections.
- Replace the wand sleeve before each patient session, as described in [Applying a wand sleeve](#).
- Dispose of wand sleeves according to standard operating procedures or local regulations for the disposal of contaminated medical waste.
- Remove and replace gloves after each patient procedure.
- Discard torn, contaminated, or used gloves.

### 11.1 Handling the wand and cable

The wand contains delicate components and should be handled with care.

When not in use, the wand should be kept in its cradle, with the blue protective sleeve attached. If you have a laptop- or mobile-configuration scanner, the wand should be stored in the supplied carrying case or trolley, with the protective sleeve attached.

Between patients, undo any twists and knots in the wand cable in order to relieve all tension. If the cable cap detaches from the wand, gently reattach it.

### 11.2 Cleaning and disinfecting the wand

The iTerO wand requires the procedures in the following sections for cleaning and disinfection.

These procedures must be carried out:

- After the scanner assembly, before first-time use
- Between patients

**Warning:** Avoid deviating from the recommended cleaning and disinfection process, and modifying or substituting recommended materials to prevent biological hazards.

You must follow all the cleaning and disinfecting steps below to ensure that the wand is properly reprocessed and ready for use.



### 11.2.1 Preparation before cleaning and disinfection

1. To avoid false activation of the wand during the cleaning and disinfection procedures, make sure to exit a scan completely by sending the scan or by going back to the home screen.
2. Remove the wand sleeve, making sure not to touch the optical surface of the wand.

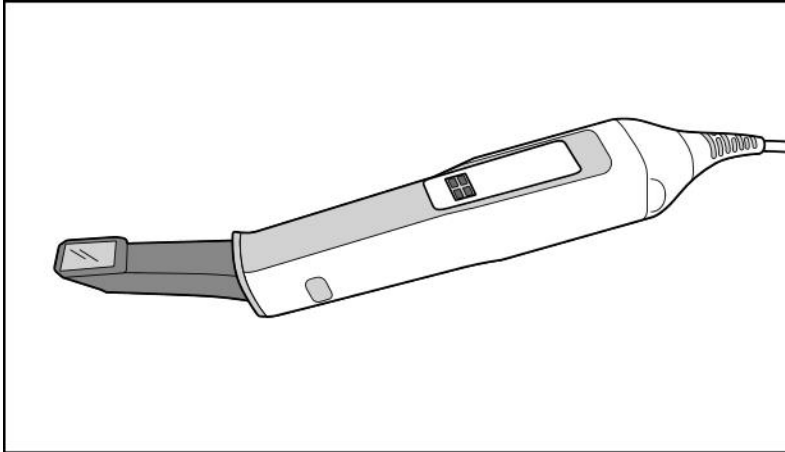

Figure 229: Wand without a sleeve

3. Visually inspect the wand for any noticeable damage, for example, deterioration such as corrosion, discoloration, pitting, or cracks.

**Warning:** Do not clean, disinfect, or use the wand if any damage is found. Please contact iTero Customer Support for further instructions.

4. Prepare the following:
  - Required cleaning and disinfecting materials:
    - CaviWipes1 (or, for a list of alternative materials and the required contact time, see [Approved cleaning and disinfecting materials](#))
    - 70% isopropyl alcohol (IPA)
    - Dry lint-free wipes
    - Soft bristle brush (e.g. the smaller end of a Healthmark Trumpet Valve Brush 1mm diameter, Cat # 3770 or equivalent)
  - Personal Protective Equipment (PPE) and work environment
    - Please follow the cleaning and disinfection material manufacturers' instructions

**Note:** Replace cleaning and disinfection materials (brushes/wipes) if visibly damaged or soiled.

**Before starting the cleaning and disinfection procedure, put on your PPE.**

## 11.2.2 Wand cleaning and disinfection

Before cleaning and disinfecting the wand, ensure that the sleeve has been removed.

### Cleaning

1. Using CaviWipes1, remove any gross contaminants on the wand body and wand tip for a minimum of one (1) minute.

**Note:** If you are using an alternative disinfectant, please refer to [Approved cleaning and disinfecting materials](#) for the required contact time.

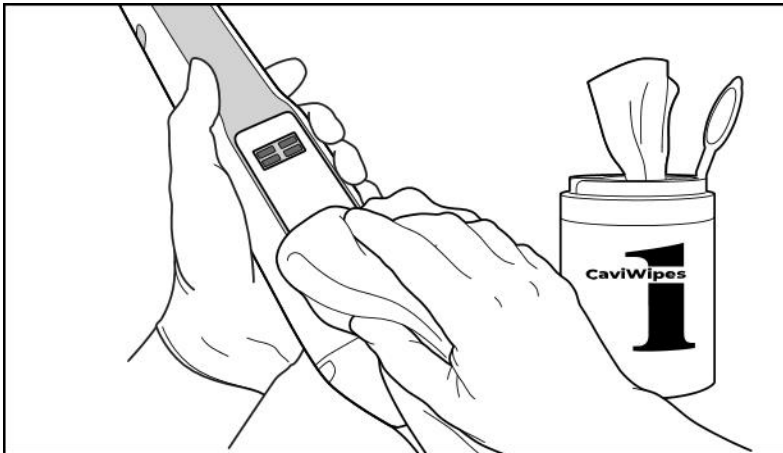

Figure 230: Remove gross contaminants using CaviWipes1

2. Using the soft bristle brush, remove any remaining marks and stains on the wand body and wand tip, paying special attention to the grooves, indents, joints, vents, etc. Brush until visibly clean.

**CAUTION:** Do not use the brush on the optical surface to prevent damage to the wand.

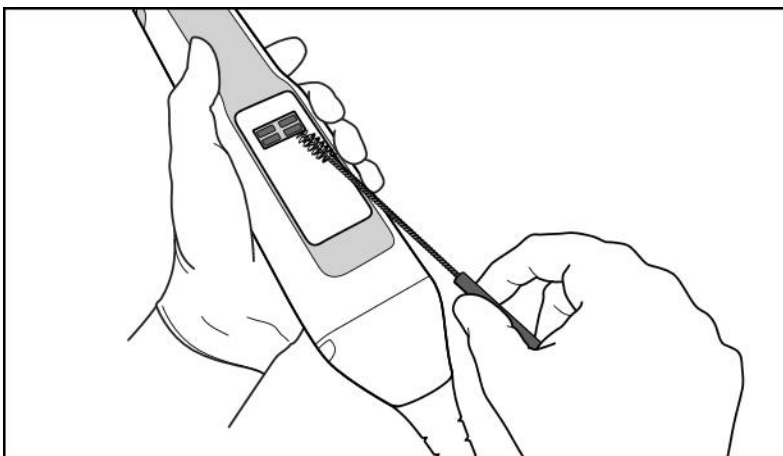

Figure 231: Remove marks and stains using a soft bristle brush

3. Using CaviWipes1, remove any remaining contaminants on the wand body and wand tip.
4. Visually inspect the device in a well-lit area to ensure all surfaces are visibly clean.

## Disinfection

1. Using CaviWipes<sup>1</sup>, thoroughly dampen all external surfaces of the wand body and wand tip, including the optical surface and ensure they remain wet for a minimum of one (1) minute.

**Note:** Use multiple fresh wipes, as necessary, to keep the wand surfaces wet for the full one (1) minute contact time.

3. Using lint-free wipe(s) wetted (but not dripping) with 70% Isopropyl Alcohol (IPA), thoroughly wipe the optical surface of the wand one (1) time until visibly clean.

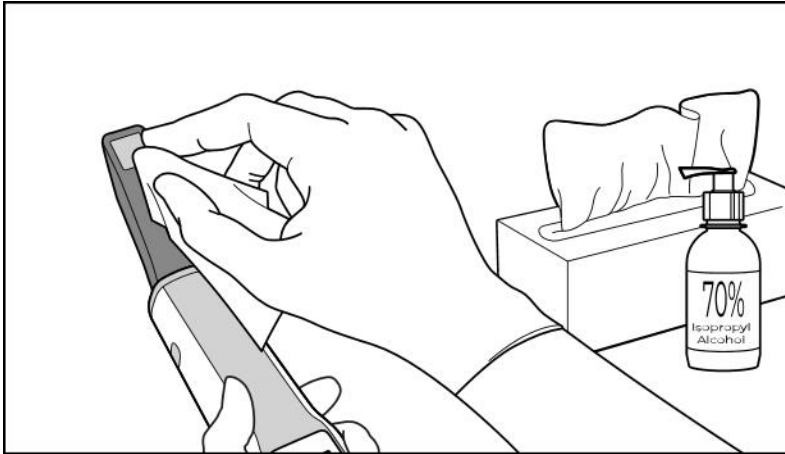

Figure 232: Wipe the optical surface of the wand with IPA

4. Wait until the optical surface dries (approximately 5–10 seconds).
5. Remove any residue from the optical surface using a dry lint-free wipe.

### 11.2.3 Drying – wand body

Air-dry the disinfected wand at room temperature.

### 11.2.4 Storage and maintenance

1. Visually inspect the wand for any noticeable damage, for example, deterioration such as corrosion, discoloration, pitting, or cracks. Pay special attention to the optical surface, making sure it remains clean.

**Warning:** Do not use the wand if any damage is detected. Please contact iTero Support for further instructions.

2. Place the blue protective sleeve on the wand tip.
3. Place the wand in the cleaned and disinfected cradle, as described in [Cleaning and disinfecting the cradle](#), below.
4. If you have a laptop- or mobile-configuration scanner, store the wand in the carrying case or trolley when not in use.

### 11.3 Cleaning and disinfecting the cradle

The wand cradle requires the procedures in the following sections for cleaning and disinfection.

These procedures must be carried out:

- After the scanner assembly, before first-time use
- Between patients

**Warning:** Avoid deviating from the recommended cleaning and disinfection guidelines, and modifying or substituting recommended materials, to prevent biological hazards.

You must follow all the cleaning and disinfecting steps below to ensure that the cradle is properly reprocessed and ready for use.

#### 11.3.1 Preparation before cleaning and disinfection

1. Visually inspect the cradle for any noticeable damage, for example, deterioration such as discoloration, pitting, or cracks.

**CAUTION:** Do not clean, disinfect, or use the cradle if any damage is detected. Please contact iTerо Customer Support for further instructions.

2. Prepare the following:

- Required cleaning and disinfecting materials:
  - CaviWipes1 (or, for a list of alternative materials and the required contact time, see [Approved cleaning and disinfecting materials](#))
  - Soft bristle brush (e.g. the smaller end of a Healthmark Trumpet Valve Brush 1mm diameter, Cat # 3770 or equivalent)
- PPE and work environment
  - Please follow the cleaning and disinfecting material manufacturers' instructions.

**Note:** Replace cleaning and disinfection materials (brushes/wipes) if visibly damaged or soiled.

**Before starting the cleaning and disinfection procedure, put on your PPE.**

### 11.3.2 Cradle cleaning and disinfection

#### Cleaning

1. Using CaviWipes1, remove any gross contaminants on the cradle for a minimum of one (1) minute.

**Note:** If you are using an alternative disinfectant, please see [Approved cleaning and disinfecting materials](#) for the required contact time.

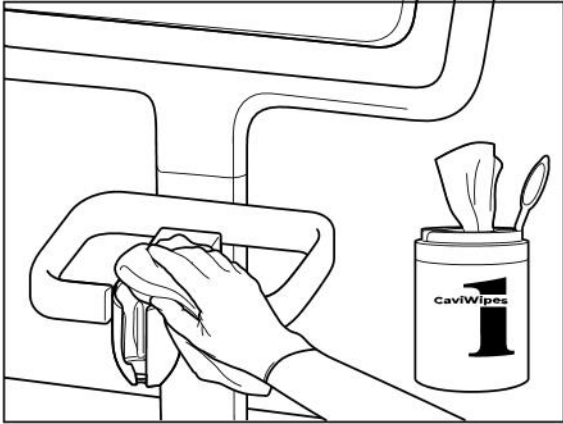

Figure 233: Wiping the iTero Element 5D cradle

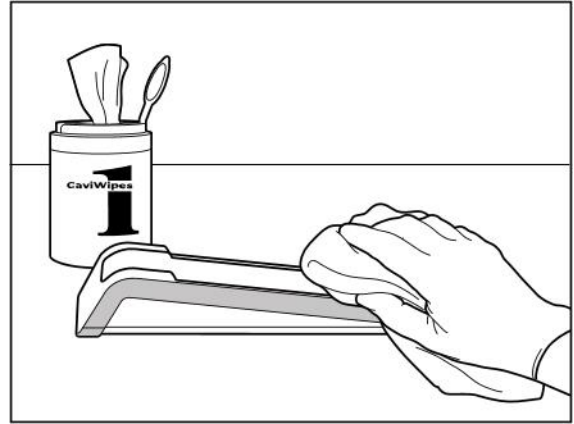

Figure 234: Wiping the iTero Element 5D laptop-configuration cradle

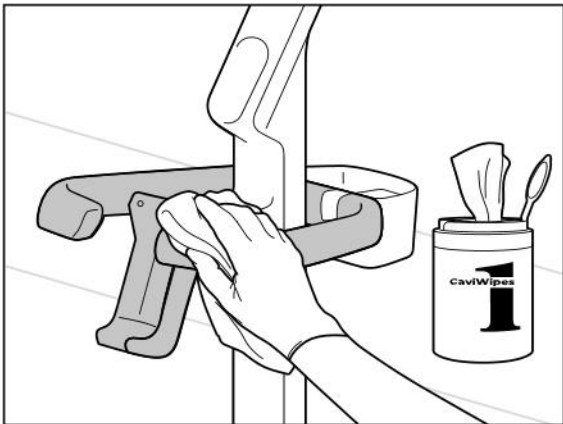

Figure 235: Wiping the iTero Element 5D Plus cart-configuration cradle



Figure 236: Wiping the iTero Element 5D Plus mobile-configuration cradle

2. Using the soft bristle brush, remove any remaining marks and stains on the cradle, paying special attention to the grooves, indents, joints, etc.

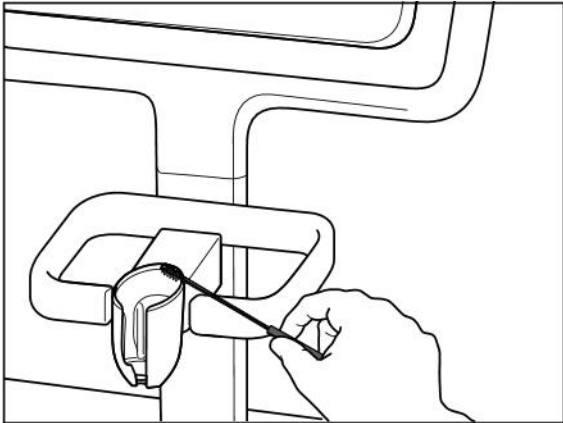

Figure 237: Brushing the iTerо Element 5D cradle

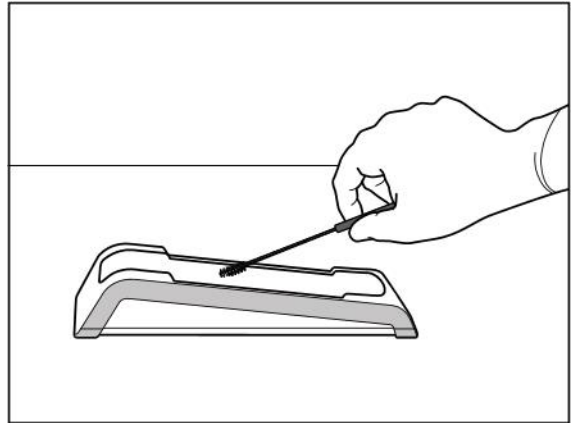

Figure 238: Brushing the iTerо Element 5D laptop-configuration cradle

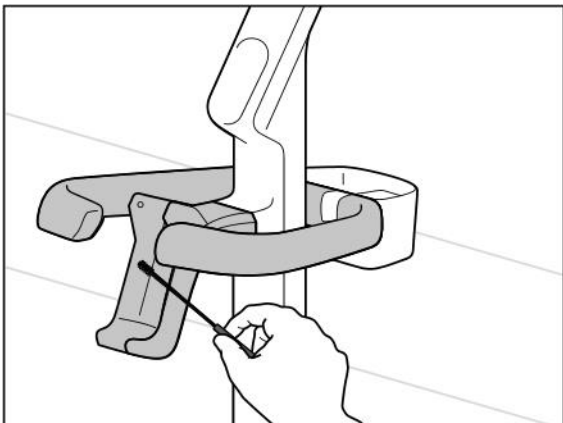

Figure 239: Brushing the iTerо Element 5D Plus cart-configuration cradle

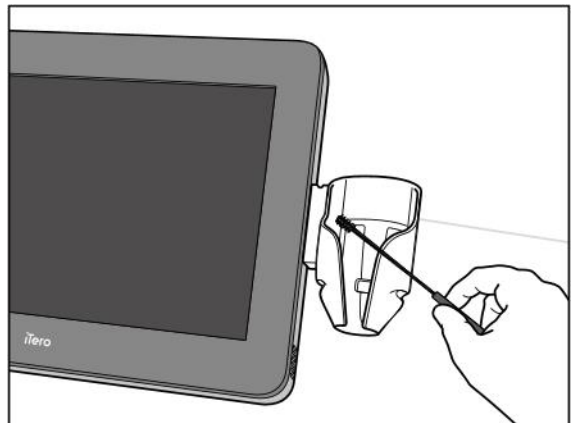

Figure 240: Brushing the iTerо Element 5D Plus mobile-configuration cradle

3. Using CaviWipes<sup>1</sup>, remove any remaining contaminants on the cradle.
4. Visually inspect the cradle in a well-lit area to ensure all surfaces are visibly clean.

#### Disinfection

- Using CaviWipes<sup>1</sup>, thoroughly dampen all external surfaces of the cradle and ensure they remain wet for a minimum of one (1) minute.

**Note:** Use multiple fresh wipes, as necessary, to keep the cradle surfaces wet for the full one (1) minute contact time.

### 11.3.3 Drying – cradle

Air-dry the disinfected cradle at room temperature.

#### 11.3.4 Storage and maintenance

Visually inspect the cradle for any noticeable damage, for example, deterioration such as discoloration, pitting, or cracks.

**Warning:** Do not use the cradle if any damage is detected. Please contact iTero Customer Support for further instructions.

The iTero Element 5D laptop-configuration cradle should be stored in the carrying case when not in use.

#### 11.4 Cleaning and disinfecting the scanner touch screen and the wheel-stand handle

The scanner screen and wheel-stand handle must be cleaned between patients, as follows:

1. Clean all outer surfaces using approved disinfectant wipes, or approved disinfectant liquid with a clean lint-free wipe, and follow the manufacturer's instructions. For a list of approved materials, see [Approved cleaning and disinfecting materials](#).
2. Remove any residual liquid disinfectant with a clean lint-free wipe.

**Note:** Do not use abrasive cleaners and/or corrosive cleaning agents or disinfectants with acids, bases, oxidizing agents, or solvents.

#### 11.5 General cleaning

All scanner parts and accessories not outlined above should be cleaned according to standard operating procedures or local regulations.

In addition to the processes described above, national standards and regulatory requirements may apply.

## 11.6 Approved cleaning and disinfecting materials

The following table lists the Align-recommended cleaning and disinfecting materials, as well as the minimum contact time required.

If you are using a liquid disinfectant, soak a clean, sterile, lint-free wipe in the liquid and squeeze until moist, and then follow the cleaning and disinfection instructions described in this document.

Material	Active Ingredient	Contact time (minutes)
CaviWipes1/CaviCide1	Quats-alcohol	1
CaviWipes/CaviCide	Quats-alcohol	3
Clorox HP Wipes	1.4% Hydrogen Peroxide	5
Oxivir® 1 Wipes	AHP Hydrogen Peroxide	1
Clinell Universal Range Wipes	≤50% Peracetic Acid	2

**Note:** If the recommended alternative disinfectants are not available in your region, consult your local supplier of disinfecting materials for equivalent products in your region. Equivalent products must meet local regulatory requirements, have the same active ingredients, and in addition, must be able to disinfect against at least Hepatitis and Tuberculosis.



## A Clinic LAN network guidelines

### A.1 Introduction

The scanner is capable of connecting to the wireless LAN in order to support the file transfer to and from the iTero cloud. Connection to other wireless devices is not supported.

Below are some helpful guidelines for the best Wi-Fi connection.

#### Levels of Wi-Fi Internet Connectivity



Excellent

>-50 dBm



Good

-50 to -60 dBm



Fair

-60 to -70 dBm



Weak

<-70 dBm

**IMPORTANT:** In order to achieve the best performance of your iTero scanner, ensure that the Wi-Fi signal strength is Excellent or at least Good.

**Warning:** Never connect the LAN cable to the scanner, in order to prevent electrical shock.

### A.2 Preparations

- The required modem/router should be configured with the WPA2 security standard, including a password.
- Ensure that your IT professional staff will be available when the scanner installation is planned to take place.
- Make sure that the Wi-Fi SSID credentials are available: Login & password.
- The minimum Wi-Fi strength signal for the system should display at least three lines, as shown above.
- Following are some suggestions for the office IT personnel, regarding what should be considered in order to prevent issues such as access or connectivity to/with the iTero scanner:
- Hostname recommendations related to Align services listening to port 443, as described in [Align hostname recommendations](#).
- Do not prevent FTP communication since the scanner sends specific file types (.3ds and .3dc/.3dm).
- Disable any proxy clients for data communication through TCP/IP.
- Do not add the scanner to any domain group.
- Do not run any group policy on the scanner as it may disrupt its proper functioning.

### A.3 Router guidelines

Minimum standards: 802.11N / 802.11AC

### A.4 Internet connection guidelines

In order to achieve the best performance of your iTerо scanner, ensure that the internet connection upload speed is at least 1Mbps per scanner. Also, note that any additional devices connected to the internet in parallel to the scanner may affect the scanner's performance.

### A.5 Firewall

Open the following port (in case of a firewall):

- 443 - HTTPS - TCP

### A.6 Wi-Fi tips

Wi-Fi routers allow you to access the internet system using a Wi-Fi connection from essentially any place within the functional range of the wireless network. Nevertheless, the number, depth, and position of walls, ceilings, or additional partitions that the wireless signals must travel through may limit the range and strength of the signal. Normal signals vary, depending on the material types and background RF (radio frequency) noise in your home or business.

- Be sure to have a minimal number of walls and ceilings between the router and other network devices. Each barrier can reduce the adapter's range by 1-3 meters (3-9 feet).
- Be sure to have a straight line, free of any partition, between network devices. Even a wall that seems rather thin can block a signal of 1 meter (3 feet) if the wall angle is shifted by only 2 degrees. To achieve the best reception, place all the devices so that the Wi-Fi signal travels straight through a wall or partition (instead of at an angle).
- Construction materials make a difference. A solid metal door, or aluminum nails, can be very dense and may have an adverse effect on a Wi-Fi signal. Try to position access points, wireless routers, and computers so that the signal travels through drywalls or open doorways. Materials and objects such as glass, steel, metal, walls with insulation, water tanks (aquariums), mirrors, file cabinets, brick, and concrete may reduce the wireless signal.
- Keep the scanner away (at least 3-6 feet or 1-2 meters) from electrical devices or appliances that generate RF noise.
- If you are using 2.4GHz cordless phones or X-10 (wireless products such as ceiling fans, remote lights, and home security systems), the wireless connection may be severely degraded or entirely drop. The base of many wireless devices transmits an RF signal, even if the device is not in use. Position any other wireless devices as far as possible from the scanner and router.
- In your area, there may be more than one active wireless network. Each network uses one or more channels. If the channel is near your system channels, the communication may gradually decline. Ask your IT department to check this, and if required, change the channel numbers used by your network.

## A.7 Align hostname recommendations

Align constantly improves its products and services, and can therefore commit to a Hostname, rather than a specific IP address.

The following list of hostnames was created to provide Align's scanners the proper operation functions, in order to be able to utilize all the advanced capabilities of the scanner performance.

Align hostname recommendation:

Hostname	Port
Mycadent.com	443
Myaligntech.com	443
Export.mycadent.com	443
Cbserver.mycadent.com	443
Matstore3.invisalign.com	443
Matstoresg.invisalign.com	443
Matstorechn.invisalign.com.cn	443
AWS IP range - Amazon global CDN service - IP address range varies depending on the location of the scanner.	443
cloud.myitero.com	443
https://itero-scanner-speed-test-prd.s3-accelerate.amazonaws.com/	443
alignapi.aligntech.com	443
https://www.google.com	443
https://www.microsoft.com	443
https://www.yahoo.com	443
iterosec.aligntech.com	443
storage.cloud.aligntech.com	443
http://*.trendmicro.com	443
https://*.trendmicro.com	8080, 21112

## B EMC declarations

### B.1 EMC declaration – iTerо Element 5D

#### IEC 60601-1-2 Edition 4.0 (2014)

Medical electrical equipment; Part 1-2: General requirements for basic safety and essential performance - Collateral Standard: Electromagnetic disturbances - Requirements and tests.

#### CFR 47 FCC

Rules and Regulations:  
Part 15. Radio frequency devices.  
Subpart B: Unintentional radiators (2015)

#### ETSI EN 301 489-1, ETSI EN 301 489-17 (relevant for wheel-stand configurations only)

Electromagnetic Compatibility (EMC) standard for radio equipment and services

#### Environment for intended use

Professional Healthcare and Home Healthcare Facility Environment

The iTerо Element 5D imaging system essential performances are:

- Display near-infrared imaging without interference on the iTerо Element 5D touch screen as part of the caries-detection solution.
- Stored scan data is accessible and can be displayed.

**Note:** Due to electromagnetic disturbance, in some cases, the image may disappear and a non-communication message will appear on the touch screen. The scanner will return to operation mode after user intervention or auto-recovery.

The following is a summary of the EMC test results for iTerо Element 5D scanners:

Test	Standard	Class / Severity level	Test results
<b>Emission</b> (IEC 60601-1-2 section 7)			
Conducted emission Freq. range: 150 kHz - 30 MHz	CISPR 11	Group 1 Class B on 230, 220, 120 & 100 VAC mains @ 50 Hz; 220 VAC mains @ 60 Hz	Complies
Radiated emission Freq. range: 30 - 1000 MHz	CISPR 11	Group 1 Class B	Complies
Harmonic current emission test	IEC 61000-3-2	230 VAC mains @ 50 Hz & 220 V @ 50 Hz & 60 Hz	Complies

Test	Standard	Class / Severity level	Test results
Voltage changes, Voltage fluctuations and Flicker test	IEC 61000-3-3	230 VAC mains @ 50 Hz & 220 VAC mains @ 50 Hz	Complies
<b>Immunity (IEC 60601-1-2 section 8)</b>			
Immunity from Electrostatic discharge (ESD)	IEC 61000-4-2	8 kV contact discharges & 15 kV air discharges	Complies
Immunity from radiated electromagnetic fields	IEC 61000-4-3	10.0 V/m; 80 MHz ÷ 2.7 GHz, 80% AM, 1 kHz	Complies
Immunity from Proximity field from wireless communications equipment	IEC 61000-4-3	List of frequencies, from 9 V/m up to 28 V/m, PM (18 Hz or 217 Hz), FM 1 kHz	Complies
Immunity from Electrical Fast transient (EFT)	IEC 61000-4-4	± 2.0 kV on 230 VAC @ 50 Hz; & 220 VAC mains @ 60 Hz; Tr/Th – 5/50 ns, 100 kHz	Complies
Immunity from Surge	IEC 61000-4-5	±2.0 CM / ±1.0 kV DM on 230 VAC mains @ 50 Hz; & 220 VAC mains @ 60 Hz; Tr/Th – 1.2/50 (8/20) ms	Complies
Immunity from conducted disturbances induced by radio-frequency fields	IEC 61000-4-6	3.0, 6.0 VRMS on 230 VAC mains @ 50 Hz & 220 VAC mains @ 60 Hz & Wand cable; 0.15÷ 80 MHz, 80% AM @ 1 kHz	Complies
Immunity from voltage dips, short interruptions and voltage variations	IEC 61000-4-11	On 230 VAC & 100 VAC mains @ 50 Hz: 0% - 0.5 cycle & 1 cycle; 70% - 25 cycles; 0% - 250 cycles; on 220 VAC mains @ 60 Hz: 0% - 0.5 cycle & 1 cycle; 70% - 30 cycles; 0% - 300 cycles	Complies

Test	Standard	Class / Severity level	Test results
<b>Emission</b> (per ETSI EN 301 489-1, ETSI EN 301 489-17)			
(relevant for wheel-stand configurations only)			
Conducted emissions on mains terminals in freq. range 150 kHz - 30 MHz	ETSI EN 301 489-1; ETSI EN 301 489-17 / EN 55032	Group 1 Class B 230 VAC mains	Complies
Radiated emissions in freq. range 30 - 6000 MHz	ETSI EN 301 489-1; ETSI EN 301 489-17 / EN 55032	Class B	Complies
Harmonic current test	ETSI EN 301 489-1; ETSI EN 301 489-17 / EN 61000-3-2	230 VAC mains	Complies
Flicker tests	ETSI EN 301 489-1 / EN 61000-3-3	230 VAC mains	Complies
<b>Immunity</b> (per ETSI EN 301 489-1, ETSI EN 301 489-17)			
(relevant for wheel-stand configurations only)			
Immunity from Electrostatic discharge (ESD)	EN 61000-4-2	4 kV contact discharge 8 kV air discharge	Complies
Immunity from radiated electromagnetic fields	EN 61000-4-3	3.0 V/m, 80 MHz , 6.0 GHz, 80% AM, 1 kHz	Complies
Immunity from Electrical Fast transient (EFT)	EN 61000-4-4	AC mains: $\pm 1.0$ kV; Tr/Th – 5/50 ns, 5 kHz	Complies
Immunity from Surge	EN 61000-4-5	AC mains: $\pm 1.0$ kV DM / $\pm 2.0$ kV CM, Tr/Th – 1.2/50 (8/20) ms	Complies
Immunity from conducted disturbances induced by radio-frequency fields	EN 61000-4-6	AC mains: 3.0 VRMS; 0.15+80 MHz, 80% AM @ 1 kHz	Complies
Immunity from Voltage interruptions	EN 61000-4-11	AC mains: 0% - 0.5 cycle & 1 cycle; 70% - 25 cycles; 0% - 250 cycles	Complies

## B.2 EMC declaration – iTero Element 5D Plus

**IEC 60601-1-2 Edition 4.0 (2014 )/EN 60601-1-2 (2015)**

Medical electrical equipment; Part 1-2: General requirements for basic safety and essential performance - Collateral Standard: Electromagnetic disturbances - Requirements and tests.

**CFR 47 FCC**

Rules and Regulations:  
Part 15. Radio frequency devices.  
Subpart B: Unintentional radiators (2020)

**ETSI EN 301 489-1, ETSI EN 301 489-17**

Electromagnetic Compatibility (EMC) standard for radio equipment and services

**Environment for intended use**

Professional Healthcare and Home Healthcare Facility Environment

The iTero Element 5D Plus imaging system essential performances are:

- Display near-infrared imaging without interference on the iTero Element 5D Plus touch screen as part of the caries-detection solution.
- Stored scan data is accessible and can be displayed.

**Note:** Due to electromagnetic disturbance, in some cases, the image may disappear and a non-communication message will appear on the touch screen. The scanner will return to operation mode after user intervention or auto-recovery.

The following is a summary of the EMC test results for iTero Element 5D Plus scanners:

Test	Standard	Class / Severity level	Test results
<b>Emission</b> (IEC 60601-1-2 / EN 60601-1-2 section 7.1 & 7.2)			
Conducted emission Freq. range: 150 kHz - 30 MHz	CISPR 11 / EN 55011	Group 1 Class B: – AC mains (240 V, 230 V, 120 V, 100 V; 220 V @ 60 Hz)	Complies
Radiated emission Freq. range: 30 - 1000 MHz	CISPR 11 / EN 55011	Group 1 Class B	Complies
Harmonic current emission test	IEC 61000-3-2 / EN 610003-2	AC mains (230 V @ 50 Hz & 220 V @ 60 Hz)	Complies
Voltage changes, Voltage fluctuations and Flicker test	IEC 61000-3-3 / EN 610003-3	AC mains (230 V @ 50 Hz & 220 V @ 50 Hz)	Complies

**Immunity** (IEC 60601-1-2 / EN 60601-1-2 sections 8.9 and 8.10)

Test	Standard	Class / Severity level	Test results
Immunity from Electrostatic discharge (ESD)	IEC 61000-4-2 / EN 61000-4-2	8 kV contact discharges & 15 kV air discharges (AC mode (230 V @ 50 Hz & 220 V @ 60 Hz) & Battery mode)	Complies
Immunity from radiated electromagnetic fields	IEC 61000-4-3 / EN 61000-4-3	10.0 V/m; 80 MHz ÷ 2.7 GHz, 80% AM, 1 kHz  (AC mode ((230 V @ 50 Hz & 220 V @ 60 Hz) & Battery mode)	Complies
Immunity from Proximity field from wireless communications equipment	IEC 61000-4-3 / EN 61000-4-3	List of frequencies, from 9 V/m up to 28 V/m, PM (18 Hz or 217 Hz), FM 1 kHz	Complies
Immunity from Electrical Fast transient (EFT)	IEC 61000-4-4 / EN 61000-4-4	± 2.0 kV on AC mains (230 V @ 50 Hz & 220 V @ 60 Hz); Tr/Th – 5/50 ns, 100 kHz	Complies
Immunity from Surge	IEC 61000-4-5 / EN 61000-4-5	±2.0 CM / ±1.0 kV DM on AC mains (230 V @ 50 Hz & 220 V @ 60 Hz); Tr/Th – 1.2/50 (8/20) µs	Complies
Immunity from conducted disturbances induced by radio-frequency fields	IEC 61000-4-6 / EN 61000-4-6	6.0 VRMS on AC mains (230 V @ 50 Hz & 220 V @ 60 Hz) & Patient cable; 0.15÷ 80 MHz, 80% AM, 1 kHz	Complies
Immunity from power frequency magnetic field	IEC 61000-4-8 / EN 61000-4-8	30 A/m @ 50 Hz & 60 Hz (AC mode and Battery mode)	Complies
Immunity from voltage dips, short interruptions and voltage variations	IEC 61000-4-11 / EN 61000-4-11	On AC mode (240 V @ 50 Hz, 100 V @ 50 Hz): 0 % - 0.5 cycle & 1 cycle; 70% - 25 cycles; 0% - 250 cycles; On AC mode (220 V @ 60 Hz): 0 % - 0.5 cycle & 1 cycle; 70% - 30 cycles; 0% - 300 cycles	Complies
<b>Emission</b> (per ETSI EN 301 489-1, ETSI EN 301 489-17)			
Conducted emissions on mains terminals in freq. range 150 kHz - 30 MHz	ETSI EN 301 489-1; ETSI EN 301 489-17 / EN 55032	Group 1 Class B 230 VAC mains	Complies



Test	Standard	Class / Severity level	Test results
Radiated emissions in freq. range 30 - 6000 MHz	ETSI EN 301 489-1; ETSI EN 301 489-17 / EN 55032	Class B	Complies
Harmonic current test	ETSI EN 301 489-1; ETSI EN 301 489-17 / EN 61000-3-2	230 VAC mains	Complies
Flicker tests	ETSI EN 301 489-1 / EN 61000-3-3	230 VAC mains	Complies
<b>Immunity</b> (per ETSI EN 301 489-1, ETSI EN 301 489-17)			
Immunity from Electrostatic discharge (ESD)	EN 61000-4-2	4 kV contact discharge 8 kV air discharge	Complies
Immunity from radiated electromagnetic fields	EN 61000-4-3	3.0 V/m, 80 MHz , 6.0 GHz, 80% AM, 1 kHz	Complies
Immunity from Electrical Fast transient (EFT)	EN 61000-4-4	AC mains: ± 1.0 kV; Tr/Th – 5/50 ns, 5 kHz	Complies
Immunity from Surge	EN 61000-4-5	AC mains: ± 1.0 kV DM / ± 2.0 kV CM, Tr/Th – 1.2/50 (8/20) ms	Complies
Immunity from conducted disturbances induced by radio-frequency fields	EN 61000-4-6	AC mains: 3.0 VRMS; 0.15+80 MHz, 80% AM @ 1 kHz	Complies
Immunity from Voltage interruptions	EN 61000-4-11	AC mains: 0% - 0.5 cycle & 1 cycle; 70% - 25 cycles; 0% - 250 cycles	Complies

## C iTerO Element product security whitepaper

*This whitepaper applies to the iTerO Element Family of products. Depending on the version of the product you have procured, there may be differences in the features of the product. In addition, as this whitepaper was created at a point-in-time, changes may have occurred in Align Technology's product security practices to address evolution and maturation in the product security ecosystem.*

### **We understand the life sciences and healthcare industry and are addressing security across the organization.**

The threat of cyber-attacks to life sciences and healthcare products is constantly evolving. With this in mind, we proactively established a product security program that is focused on minimizing the security risk associated with our products, enabling us to be vigilant when facing emerging threats and to continuously improve our products.

We recognized the importance of incorporating security and privacy considerations by design and throughout our product lifecycle. To accomplish this, we established a cross-functional product security team, including representatives from engineering/software development, security, legal/privacy, information technology, and quality.



### **We identify security risks using robust risk management processes.**

Align Technology is committed to addressing and minimizing security and privacy risks in the products that we design, develop, and maintain. We conduct in-depth assessments of our products so that we can implement appropriate risk mitigation measures at the outset of product development. Based on the risk level of the product, as well as the functionality of the product, the below methodology is applied.

**Product Security Risk Management Program:** Align Technology conducted the program on the iTerO Element Family of products. The methodology included planning and information gathering, scoping product ecosystem, performing a product security risk assessment, analyzing threats and vulnerabilities, assessing applicable security controls, and calculating the residual risk rating of any identified gaps. Security and privacy risks and controls considered as part of the assessment leverage industry leading practice security risk frameworks including, but not limited to, AAMI TIR57, NIST CSF, IEC/TR 80001-2-2, and the FDA's Content of Premarket Submissions for Management of Cybersecurity in Medical Devices.



## Security and privacy features of the product.

We aim to protect your data and patients through the design and maintenance of our products. As a result of our security- and privacy-by-design approach to product development, we have implemented the following non-exhaustive security controls in the iTero Element Family of products.

- **Data-at-rest is encrypted:** The scanners store Personally Identifiable Information (PII) in an encrypted database using AES-256 and intraoral scan images in an encrypted folder using Microsoft Encrypting File System (EFS). These encryption technologies help to prevent an attacker from capturing patient information stored on the scanner.

*Applicable to iTero Element, iTero Element 2, iTero Element Flex, iTero Element 5D, and iTero Element 5D Laptop Configuration, iTero Element 2 Plus, iTero Element 5D Plus, iTero Element 5D Plus Lite*

- **Data-in-transit is encrypted:** PII and intraoral scan images that are backed up to Align servers is transmitted over transport layer security (TLS) 1.2 encryption using trusted certificates. This helps to prevent an attacker from capturing patient information while in transit.

*Applicable to iTero Element, iTero Element 2, iTero Element Flex, iTero Element 5D, and iTero Element 5D Laptop Configuration, iTero Element 2 Plus, iTero Element 5D Plus, iTero Element 5D Plus Lite*

- **Anti-malware protections are in place:** The scanners come with pre-installed Trend Micro anti-virus software that checks for malicious files on the system. The anti-virus software definitions are updated frequently and scans are scheduled to run daily on the devices.

*Applicable to iTero Element, iTero Element 2, iTero Element 5D, iTero Element 2 Plus, iTero Element 5D Plus, iTero Element 5D Plus Lite*

- **Remote maintenance is not possible without permission:** The devices use TeamViewer for establishing a remote session. The TeamViewer software requires a User ID and password that must be supplied from the customer to the Align service personnel before the connection can take place.

*Applicable to iTero Element, iTero Element 2, iTero Element Flex, iTero Element 5D, and iTero Element 5D Laptop Configuration, iTero Element 2 Plus, iTero Element 5D Plus, iTero Element 5D Plus Lite*

- **Changes to the operating system and software are restricted:** The scanners implement a kiosk mode that prevents the user from making any unwanted changes to the operating system and software components.

*Applicable to iTero Element, iTero Element 2, iTero Element 5D, iTero Element 2 Plus, iTero Element 5D Plus, iTero Element 5D Plus Lite*

- **User access management controls are enforced:** A user account and password is required to utilize the scanners. This helps protect access to the scanner and protects against unauthorized use.

*Applicable to iTero Element, iTero Element 2, iTero Element Flex, iTero Element 5D, and iTero Element 5D Laptop Configuration, iTero Element 2 Plus, iTero Element 5D Plus, iTero Element 5D Plus Lite*

- **Segregation of duties is applied:** The scanners offer the ability to register multiple user accounts with different roles to one scanner. There are roles for Doctor, Assistant, and Support Technician. This helps ensure the ability to track activities performed by individual users better protecting the device.

*Applicable to iTero Element, iTero Element 2, iTero Element Flex, iTero Element 5D, and iTero Element 5D Laptop Configuration, iTero Element 2 Plus, iTero Element 5D Plus, iTero Element 5D Plus Lite*

## Security and privacy responsibilities of the customer.

As part of our assessments, we have identified risks that are dependent on how the product is used. The securing of the products we provide to our customers is a shared responsibility among all stakeholders. Based on the assessment conducted on the iTerO® Element™ optical impression system series, we expect that you will take the following security steps to protect the product:

- **Physically secure the product and its operating environment:** It is the customer's responsibility to protect the physical security of the product and operate it in a secure manner. For the iTerO® Element™ Flex system, control and monitor physical access to the platform hosting the application through the use of mechanisms such as security cameras and security badges. In addition, shut down physical ports of network equipment that is not in use to prevent unauthorized access to the application.

*Applicable to iTerO Element, iTerO Element 2, iTerO Element Flex, iTerO Element 5D, and iTerO Element 5D Laptop Configuration, iTerO Element 2 Plus, iTerO Element 5D Plus, iTerO Element 5D Plus Lite*

- **Securely operate and protect your network:** It is the customer's responsibility to secure your network through the use of network intrusion detection and prevention mechanisms, using adequately hardened network/application firewalls, and network segmentation, especially if exposed to public Internet. Additionally, dispose of data in an appropriate manner, complying with all local laws and regulations.

*Applicable to iTerO Element, iTerO Element 2, iTerO Element Flex, iTerO Element 5D, and iTerO Element 5D Laptop Configuration, iTerO Element 2 Plus, iTerO Element 5D Plus, iTerO Element 5D Plus Lite*

- **Detect malicious and mobile code:** It is the customer's responsibility to select and implement anti-virus/anti-malware protection for the iTerO® Element™ Flex host machine. Additional CPU and memory resources should be provided, if necessary, in order to prevent any degradation in performance caused by the execution of this software.

*Applicable to iTerO Element Flex and iTerO Element 5D Laptop Configuration*

- **Create strong passwords and protect login credentials:** It is the customer's responsibility to set strong passwords with to access scanners and Align systems. The more characters it has with special characters, the stronger it is. Using a passphrase without personal information is one of the simplest ways to ensure that you have a strong password along with changing it every 90 days. Protect your username and password login credentials granting you access to scanners and Align systems by not sharing with anyone and working in a secure environment.

*Applicable to iTerO Element, iTerO Element 2, iTerO Element Flex, iTerO Element 5D, and iTerO Element 5D Laptop Configuration, iTerO Element 2 Plus, iTerO Element 5D Plus, iTerO Element 5D Plus Lite*

- **Apply segregation of duties and timely remove staff accounts when no longer needed:** If customer has multiple user accounts with access to the scanner, it is the customer's responsibility to register those multiple user accounts with the appropriate role of Doctor, Assistant, or Support Technician. This helps ensure the ability to track activities performed by individual users better protecting the device. Additionally, it is the customer's responsibility to remove user accounts when staff no longer require the access to the scanner.

*Applicable to iTerO Element, iTerO Element 2, iTerO Element Flex, iTerO Element 5D, and iTerO Element 5D Laptop Configuration, iTerO Element 2 Plus, iTerO Element 5D Plus, iTerO Element 5D Plus Lite*

- **Ensure current data backup and maintain latest software version:** It is the customer's responsibility to ensure scanners remain connected to Align systems to backup PII and intraoral scan images to Align servers and are being restarted as requested to ensure latest scanner updates are being applied.

*Applicable to iTerO Element, iTerO Element 2, iTerO Element Flex, iTerO Element 5D, and iTerO Element 5D Laptop Configuration, iTerO Element 2 Plus, iTerO Element 5D Plus, iTerO Element 5D Plus Lite*

- **Exported data not encrypted:** It is the customer's responsibility to protect exported data, such as intraoral images, by using mechanisms such as digital signatures or encrypting removable media.

*Applicable to iTerO Element Flex and iTerO Element 5D Laptop Configuration*

If you have any questions or concerns about the risks as they are described, please do not hesitate to contact [TRM@aligntech.com](mailto:TRM@aligntech.com) or [privacy@aligntech.com](mailto:privacy@aligntech.com).

## D System specifications

This section includes the specifications for the following systems:

- [iTero Element 5D wheel-stand configuration system specifications](#)
- [iTero Element 5D laptop-configuration system specifications](#)
- [iTero Element 5D Plus system specifications](#)

## D.1 iTerо Element 5D wheel-stand configuration system specifications

<b>Monitor</b>	21.5" Full HD (1920x1080) touch screen	
<b>Wand</b>	<ul style="list-style-type: none"> <li>The wand emits red laser light (680nm Class 1), as well as white LED emissions and 850nm LED emissions.</li> <li>Wand operating power: 15VDC</li> </ul>	
<b>Wireless LAN</b>	A LAN card provides local network communications with wireless connectivity	
<b>Security</b>	See <a href="#">iTerо Element product security whitepaper</a> .	
<b>Operating Power</b>	100-240 VAC- 50/60 Hz- 200 VA (max)	
<b>Operating Temperature</b>	18°C to 26°C / 64.4°F to 78.8°F	
<b>Storage/Transportation Temperature</b>	-5°C to 50°C / 23°F to 122°F	
<b>Operating Pressure and Altitude</b>	Pressure: 520 mmHg to 771 mmHg (-69 kPa to -103 kPa) Altitude: -400 feet to 10,000 feet	
<b>Storage/Transportation Pressure and Altitude</b>	Pressure: 430 mmHg to 760 mmHg (~57 kPa to ~101 kPa) Altitude: 0 feet to 15,000 feet	
<b>Relative Humidity</b>	Operating: 40% to 70% Storage: 30% to 90%	
<b>Dimensions</b>	iTerо Full HD touch-screen computing unit: <ul style="list-style-type: none"> <li>Height: 356 mm (~14 in)</li> <li>Width: 552 mm (~21.7 in)</li> <li>Depth: 65 mm (~2.5 in)</li> </ul> Wand: <ul style="list-style-type: none"> <li>Length: 346 mm (13.3 in)</li> <li>Width: 50 mm (~2.0 in)</li> <li>Depth: 68 mm (~2.7 in)</li> </ul>	Wheel stand: <ul style="list-style-type: none"> <li>Height: 1280 mm (~50 in)</li> <li>Width: 645 mm (~25 in)</li> <li>Depth: 625 mm (~24.5 in)</li> </ul>
<b>Net Weight</b>	Monitor: 8.3 kg (~18.3 lbs.) Wand: 0.47 kg (~1.0 lbs.) without the cable Wheel stand: ~13.6 kg (~30 lbs.)	

## D.2 iTero Element 5D laptop-configuration system specifications

<b>Monitor</b>	Laptop screen	
<b>Wand</b>	<ul style="list-style-type: none"> <li>• The wand emits red laser light (680nm Class 1), as well as white LED emissions and 850nm LED emissions.</li> <li>• Wand operating power: 15VDC</li> </ul>	
<b>Security</b>	Align Technology takes the responsibility of securing the data of our customers and their patients very seriously. All patient data is transmitted via an encrypted TLS channel, and communications and information are securely stored, enabling our customers to take reasonable measures to protect their patient data.	
<b>Operating power</b>	100-240VAC- 50/60 Hz-40VA (max)	
<b>Operating temperature</b>	18°C to 26°C / 64.4°F to 78.8°F	
<b>Storage/Transportation temperature</b>	-5° to 50°C / 23° to 122°F	
<b>Operating altitude</b>	Altitude: 0 feet to 10,000 feet	
<b>Storage/Transportation altitude</b>	Altitude: 0 feet to 15,000 feet	
<b>Relative humidity</b>	Operating: 40% to 70% Storage: 30% to 90%	
<b>Dimensions</b>	iTero Element 5D laptop-configuration hub: <ul style="list-style-type: none"> <li>• Length: 206 mm (~8 in)</li> <li>• Width: 94 mm (~3.7 in)</li> <li>• Depth: 36.5 mm (~1.4 in)</li> </ul> iTero Element 5D wand: <ul style="list-style-type: none"> <li>• Length: 346 mm (13.3 in)</li> <li>• Width: 50 mm (~2.0 in)</li> <li>• Depth: 68 mm (~2.7 in)</li> </ul>	iTero Element 5D laptop-configuration cradle: <ul style="list-style-type: none"> <li>• Length: 262 mm (~10 in)</li> <li>• Width: 89 mm (~3.5 in)</li> <li>• Depth: 52 mm (~2 in)</li> </ul> Carrying case: <ul style="list-style-type: none"> <li>• Height: 326.5 mm (~13 in)</li> <li>• Width: 455 mm (~18 in)</li> <li>• Depth: 184 mm (~7 in)</li> </ul>
<b>Net weight</b>	iTero Element 5D laptop- configuration hub: ~0.5 kg (~1 lbs.) iTero Element 5D laptop-configuration wand: 0.47 kg (~1 lbs.) Empty carrying case: ~2 kg (~4.5 lbs.)	
<b>Shipping weight</b>	~8 kg (~17.6 lbs.)	

### D.3 iTerro Element 5D Plus system specifications

	<b>Cart configuration</b>	<b>Mobile configuration</b>
<b>Monitor</b>	21.5" Full HD (1920x1080) touch screen	15.6" Full HD (1920x1080) touch screen
<b>Wand</b>	<ul style="list-style-type: none"> <li>The wand emits red laser light (680nm Class 1), as well as white LED emissions and 850nm LED emissions.</li> <li>Wand operating voltage: 15VDC</li> </ul>	
<b>Wireless LAN</b>	A LAN card provides local network communications with wireless connectivity <ul style="list-style-type: none"> <li>2.4GHz, 5GHz</li> <li>802.11ac</li> </ul>	
<b>Security</b>	See <a href="#">iTerro Element product security whitepaper</a> .	
	<b>Cart configuration</b>	<b>Mobile configuration</b>
<b>Operating Power</b>	100-240 VAC- 50/60 Hz- 300 VA (max)	100-240 VAC- 50/60 Hz- 250 VA (max)
<b>Operating environmental conditions</b>		
• <b>Temperature</b>	18°C to 26°C / 64.4°F to 78.8°F	
• <b>Relative Humidity</b>	40% to 70% (non condensing)	
• <b>Altitude</b>	-400 feet to 10,000 feet	
<b>Transportation environmental conditions</b>		
• <b>Temperature</b>	-5°C to 50°C / 23°F to 122°F	
• <b>Relative Humidity</b>	30% to 90% (non condensing)	
• <b>Altitude</b>	-400 feet to 15,000 feet	
<b>Storage environmental conditions</b>		
• <b>Temperature</b>	-5°C to 50°C / 23°F to 122°F	
• <b>Relative Humidity</b>	30% to 90% (non condensing)	
• <b>Altitude</b>	-400 feet to 15,000 feet	



**Physical properties**

<ul style="list-style-type: none"> <li>• <b>Wand</b></li> </ul>	<ul style="list-style-type: none"> <li>• Length: 346 mm (13.3 in)</li> <li>• Width: 50 mm (~2.0 in)</li> <li>• Depth: 68 mm (~2.7 in)</li> </ul>	
	<p><b>Cart configuration</b></p> <ul style="list-style-type: none"> <li>• Height: 356 mm (~14 in)</li> <li>• Width: 544 mm (~21.5 in)</li> <li>• Depth: 60.5 mm (~2.3 in)</li> </ul>	<p><b>Mobile configuration</b></p> <ul style="list-style-type: none"> <li>• Height: 275 mm (~10.8 in)</li> <li>• Width: 419 mm (~16.5 in)</li> <li>• Depth: 41.5 mm (~1.6 in)</li> </ul>
<ul style="list-style-type: none"> <li>• <b>iTero Full HD touch-screen computing unit</b></li> </ul>	<p><b>Cart configuration</b></p> <ul style="list-style-type: none"> <li>• Height: 1279 mm (~50.3 in)</li> <li>• Width: 544 mm (~21.4 in)</li> <li>• Depth: 562 mm (~22.1 in)</li> </ul>	<p><b>Mobile configuration</b></p> <p>N/A</p>
<ul style="list-style-type: none"> <li>• <b>Wheel stand</b></li> </ul>	<p><b>Cart configuration</b></p> <ul style="list-style-type: none"> <li>• Height: 1279 mm (~50.3 in)</li> <li>• Width: 544 mm (~21.4 in)</li> <li>• Depth: 562 mm (~22.1 in)</li> </ul>	<p><b>Mobile configuration</b></p> <p>N/A</p>
<ul style="list-style-type: none"> <li>• <b>Cable length</b></li> </ul>	<p>Wand cable: 1.8 m typical</p> <p>Power cable: 3000 mm</p>	<p>Wand cable: 1.8 m typical</p> <p>Power cable: 1600 mm or 3000 mm</p>
<ul style="list-style-type: none"> <li>• <b>Net Weight</b></li> </ul>	<p><b>Cart configuration</b></p> <p>Computing unit: 10.5 kg (~23.1 lbs.)</p> <p>Wand: 0.47 kg (~1.0 lbs.) without the cable</p> <p>Wheel stand: ~12.5 kg (~27.5 lbs.)</p>	<p><b>Mobile configuration</b></p> <p>Computing unit with cradle and wand: ~5.5 kg (~12.0 lbs.)</p> <p>System packed in trolley: ~11 kg (~24.0 lbs.)</p> <p>Wand: 0.47 kg (~1.0 lbs.) without the cable</p>
<p><b>CPU Specifications</b></p>	<p>Intel® Core™ i7</p>	
<p><b>GPU Specifications</b></p>	<p>Nvidia</p>	
<p><b>Battery</b></p>	<p>Integrated battery for uninterrupted scanning and ease in office portability without plugging in or rebooting, providing:</p> <ul style="list-style-type: none"> <li>• At least 30 minutes of active continuous scanning (cart configuration) and 10 minutes (mobile configuration)</li> <li>• &lt;2.5 hours for full recharge</li> </ul>	
<p><b>Scanner and wand cross-contamination protection</b></p>	<ul style="list-style-type: none"> <li>• Single-use, disposable sleeves</li> </ul>	

<b>Accessible ports</b>	USB types A and C
<b>Scanning technology</b>	Parallel Confocal technology
<b>Scanning properties</b>	<ul style="list-style-type: none"><li>• No hovering required – scanning can be done at a distance of 0mm</li><li>• No field calibration needed</li><li>• Flexible scanning protocol (start anywhere, auto stitching)</li><li>• Automated heating of the tip to avoid fogging of the lens</li></ul>
<b>Scan time</b>	Full mouth can be completed in as little as 60 seconds.
<b>Cloud storage</b>	Data can be stored and accessed on the web using cloud storage and the MyiTero web portal.





Align Technology, Inc.  
410 North Scottsdale Road,  
Suite 1300, Tempe,  
Arizona 85281  
USA

© 2022 Align Technology, Inc. All rights reserved. Align, Invisalign, iTero, among others, are trademarks and/or service marks of Align Technology, Inc. or one of its subsidiaries or affiliated companies and may be registered in the U.S. and/or other countries. 215411 Rev. B

